

# **M&T**

manufacture 1997

Představujeme Vám vyjímečný povrch **Cr-K černý chrom broušený 3D**

Originální, ručně broušený povrch, vzhledově  
i hmatově navozující atmosféru drásaného dřeva.





Dveřní kliky NEREZ [28 – 39]



Dveřní kliky DESIGN 2021 - Up & Down [168 – 173]



Dveřní kliky NEREZ + magnetické rozety [40 – 71]



Dveřní kliky DESIGN 2023 - Nomad, Nomad Touch [174 – 183]

NOVINKA



Dveřní kliky DESIGN 2000, 2004 [72 – 83]



Štítové kování NEREZ, DESIGN 2000, 2004 [184 – 199]



Dveřní kliky DESIGN 2006 [84 – 87]  
Dveřní kliky DESIGN 2009 [88 – 95]



Bezpečnostní kování, Bezpečnostní madla Entero [200 – 209]



Dveřní kliky DESIGN 2011 řada MINI [96 – 99]



Bezpečnostní rozety [210 – 217]



Dveřní kliky a kování DESIGN 2013 řada MINIMAL/MAXIMAL [100 – 113]  
Dveřní kliky DESIGN 2021 MINIMAL 2.0 WC integrated [114 – 125]



Madla dlouhá [218 – 225]



Kliky + magnetické rozety DESIGN 2017 [126 – 145]



Systém Magnetic [226 – 233]



Dveřní kliky DESIGN 2018 - Rocksor, Industry Squelette [146 – 167]

Ovládací madla k systému Magnetic [234 – 261]

NOVINKA



VÝHODNÝ SET

Okenní kliky 3 a 4 polohové [262 – 269]



Madla a koule na skleněné a dřevěné dveře [332 – 337]



Okenní kliky 225, 250 mm / HS Portaly na posuvná okna a stěny [270 – 277]



Posuvný systém MINIMA pro dřevěné a skleněné dveře [338 – 345]



Kování pro hliníkové a ocelové dveře, kování na branky [278 – 289]



Neviditelné zárubně a sokly MINIMA [346 – 351]



Mušle na posuvné dveře [290 – 307]



Magnetické zámky [352 – 355]



Mušle Minimal / Maximal na skleněné posuvné dveře [308 – 311]



Panty na dřevěné dveře [356 – 359]



Kliky a zámky na skleněné dveře [312 – 321]



Dveřní zárážky [360 – 365]



Panty na skleněné dveře [322 – 325]



Montážní PROFI šablona [366 – 367]



Nerezové kliky, zámky a panty na skleněné dveře [326 – 331]



Příslušenství a komponenty [368 – 373]



Dveřní kliky NEREZ



Dveřní kliky NEREZ + magnetické rozety



Dveřní kliky DESIGN 2000, 2004



Dveřní kliky DESIGN 2006  
Dveřní kliky DESIGN 2009



Dveřní kliky DESIGN 2011  
řada MINI



Dveřní kliky a kování DESIGN 2013  
řada MINIMAL/MAXIMAL  
Dveřní kliky DESIGN 2021  
MINIMAL 2.0 WC integrated  
Kliky + magnetické rozety  
DESIGN 2017



Dveřní kliky DESIGN 2018 - Rocksor,  
Industry Squelette



Dveřní kliky DESIGN 2021 - Up & Down



Dveřní kliky DESIGN 2023 - Nomad,  
Nomad Touch



Štítové kování NEREZ,  
DESIGN 2000, 2004



Bezpečnostní kování,  
Bezpečnostní madla Entero



Bezpečnostní rozety



Madla dlouhá



Systém Magnetic



Ovládací madla k systému Magnetic



Okenní kliky 3 a 4 polohové



Okenní kliky 225, 250 mm /  
HS Portaly na posuvná okna a stěny



Kování pro hliníkové a ocelové dveře,  
kování na branky



Mušle na posuvné dveře



Mušle Minimal / Maximal  
na skleněné posuvné dveře



Kliky a zámky na skleněné dveře



Panty na skleněné dveře



Nerezové kliky, zámky a panty  
na skleněné dveře



Madla a koule na skleněné  
a dřevěné dveře



Posuvný systém MINIMA pro dřevěné  
a skleněné dveře



Neviditelné zárubně a sokly MINIMA



Magnetické zámky



Panty na dřevěné dveře



Dveřní zárážky



Montážní PROFI šablona



Příslušenství a komponenty



Dveřní kliky NEREZ



Lusy [str. 30]



Deny [str. 30]



Hanna [str. 38]



Senza [str. 32]



Promo [str. 32]



Entero [str. 32]



Lusy [str. 34]



Deny [str. 34]



Meclis [str. 34]



Senza [str. 36]



Promo [str. 36]



Entero [str. 36]

Dveřní kliky NEREZ + magnetické rozety



Lusy [str. 40]



Deny [str. 40]



Meclis [str. 42]



Morgan [str. 42]



Jameson [str. 44]



Nova [str. 44]



Promo [str. 56]



Senza [str. 46]



Entero [str. 48]



Kvadra [str. 48]



Techno [str. 50]



Sonia [str. 52]



Morgan [str. 30]



Jameson [str. 30]



Nova [str. 30]



Kvadra [str. 32]



Techno [str. 32]



Cesan [str. 32]



Morgan [str. 34]



Jameson [str. 34]



Nova [str. 34]



Kvadra [str. 36]



Techno [str. 36]



Sonia [str. 38]



Lusy [str. 56]



Deny [str. 56]



Morgan [str. 58]



Hanna [str. 52]



Jameson [str. 60]



Nova [str. 60]



Promo [str. 62]



Senza [str. 62]



Kvadra [str. 64]



Entero [str. 64]



Sonia [str. 68]



Cesan [str. 66]

Kliky + magnetické rozety  
materiál: masivní mosaz 

Cesan [str. 130]



Entero [str. 130]



Burak [str. 132]



Andy [str. 132]



Sogut [str. 134]



Cherez [str. 134]



Entero [str. 142]



Entero [str. 142]



Dveřní kliky DESIGN 2000  
materiál: masivní mosaz 

Cesan [str. 74]



Garanti [str. 74]



Burak [str. 74]



Kemer [str. 76]



Deny [str. 76]



Lusy [str. 76]



Dveřní kliky DESIGN 2004  
materiál: masivní mosaz 

Entero madlo [str. 80]



Entero [str. 80]



Lara [str. 80]



Garanti [str. 80]



Cherez [str. 82]



Mondeo [str. 82]





Entero [str. 130]



Lusy [str. 136]



Deny [str. 136]



Lusy [str. 140]



Sogut [str. 140]



Lusy [str. 140]



Deny [str. 140]



Fábi [str. 74]



Andy [str. 74]



Mondeo [str. 74]



Maty [str. 76]



Mia [str. 78]



Sogut [str. 78]



Meclis [str. 78]



Cherez [str. 78]



Garanti [str. 80]



Sogut [str. 80]



Sogut [str. 80]



Lusy [str. 80]



Deny [str. 82]



Dveřní kliky DESIGN 2006  
materiál: masivní mosaz 

Entry [str. 86]

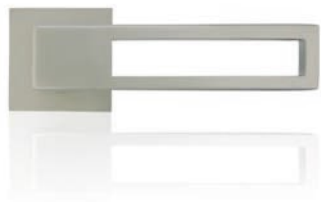

Trinity [str. 86]

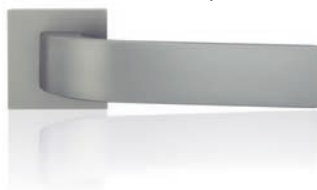

My [str. 86]



Terry [str. 86]



Entero [str. 86]



Entry [str. 86]



Dveřní kliky DESIGN 2011  
materiál: masivní mosaz 

Mini-V [str. 98]



Mini-C [str. 98]



Mini-S [str. 98]



Mini-T [str. 98]



Dveřní kliky DESIGN 2009  
materiál: masivní mosaz 

Tukan [str. 90]

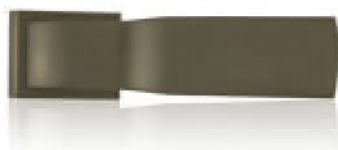

Maya [str. 90]



Toro [str. 90]



Mimolimit [str. 92]



Dveřní kliky DESIGN 2013 řada MINIMAL, MAXIMAL  
materiál: masivní mosaz 

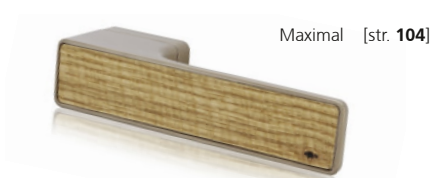

Dveřní kliky DESIGN 2021 řada MINIMAL 2.0  
materiál: masivní mosaz 

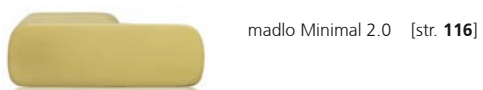

Dveřní kliky DESIGN 2021 řada MINIMAL 2.0 WC integrated  
materiál: masivní mosaz 

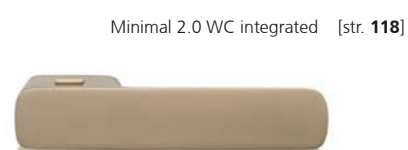

Dveřní kliky DESIGN 2018 Rocksor  
materiál: masivní mosaz

Rocksor [str. 148]



Rocksor [str. 148]



Rocksor U [str. 148]



Rocksor [str. 148]



Rocksor [str. 148]



Rocksor [str. 152]



madlo Rocksor [str. 148]



Dveřní kliky DESIGN 2018 Industry Squelette  
materiál: nerezová ocel

Industry Squelette [str. 159]



Industry Squelette [str. 158]



madlo Industry Squelette [str. 158]



Industry Squelette [str. 159]



Industry Squelette [str. 158]



Industry Squelette [str. 158]



Industry Squelette [str. 162]



Dveřní kliky DESIGN 2021 Up  
materiál: masivní mosaz 

Up [str. 170]



Up [str. 170]



Up [str. 170]



Up [str. 170]



Up [str. 170]



Dveřní kliky DESIGN 2021 Down  
materiál: masivní mosaz 

Down [str. 170]



Down [str. 170]



Down [str. 170]



Down [str. 170]



Dveřní kliky DESIGN 2023 Nomad  
materiál: masivní mosaz 

Nomad [str. 176]



Nomad [str. 176]



Nomad [str. 176]



Dveřní kliky DESIGN 2023 Nomad Touch  
materiál: masivní mosaz 

Nomad Touch [str. 178]



Nomad Touch [str. 178]



Nomad Touch [str. 178]



# POVRCHY

Jsme lídři v povrchových úpravách



Bílá mat

Nikl satén mat

Chrom lesk

Titan chrom mat

Mosaz leštěno

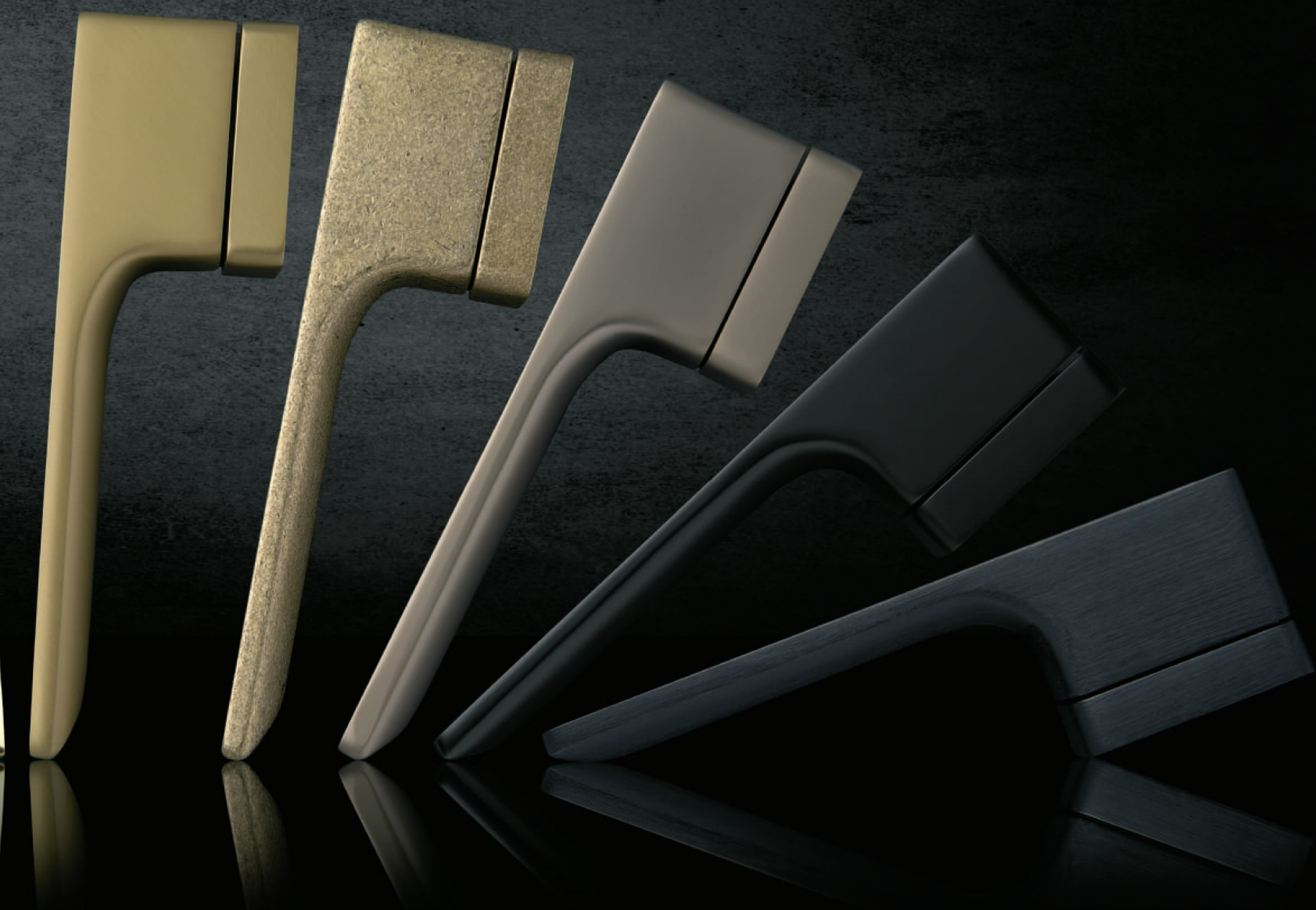

Titan mosaz mat

Mosaz natural

Titan braun mat

Titan černý mat

Chrom černý 3D broušeno

# Barvy & povrchy



**TIN-G**  
titan graphite mat

Fyzikálně naprašovaný povrch v šedo/černém ocelovém odstínu dotváří škálu tmavých odstínů M&T pro co nejdokonalejší sladění interiérů a exteriérů s okolním prostředím. Povrch lze zajímavě kombinovat s černo/černým povrchem TiN-K.

- termín výroby .. 4-8 týdnů
- záruka .. 15 let
- použití .. interiéry i exteriéry
- údržba .. prostředek M&T TITAN
- množstevní podmínka .. pouze pro zakázky nad 50 párů kování, případně od 1 páru s termínem dodání 3 - 6 měsíců



**Cr-K**  
černý chrom broušený 3D

Galvanické pokovení na mosazný výrobek s předupraveným povrchem s jemnou ručně broušenou 3D strukturou, která splňuje náročné požadavky na moderní architekturu, ale zároveň i na stylové tradiční stavby. Matný černý povrch té nejvyšší kvality.

- termín výroby .. 4 - 6 týdnů
- záruka .. 5 let
- použití .. interiéry i exteriéry
- údržba .. bezúdržbové, bavlněný hadřík, popř. prostředek SITOL



**TIN-K**  
titan černý mat

Fyzikálně naprašovaný povrch s nejdelší tradicí – to je černý titan, který aplikujeme na své výrobky už od r. 2000. Za tuto dobu získal tento povrch mnoho příznivců, převážně investorů high staveb a interiérů, kam je svým odstínem předurčen. Nejedná se o běžnou černou barvu, ale o metalický šedo/černý odstín, který ihned zaujme svoji strukturou a nezaměnitelným kovovým odstínem.

- termín výroby .. 4 týdnů
- záruka .. 15 let
- použití .. interiéry i exteriéry
- údržba .. prostředek M&T TITAN



**K-industrial**  
černý mat strukturovaný

Naprašovaný tvrdý povrch s hrubou strukturou navazující na industriální období přelomu 19. a 20. století. Předností povrchu je nejen nezaměnitelný vzhled, ale i velmi příjemný dotykový dojem. Povrch je prioritně připraven pro všechny produkty z nerezové oceli, lze nanášet i na mosazné výrobky.

- termín výroby .. 4 týdnů
- záruka .. 5 let
- použití .. interiéry i exteriéry
- údržba .. prostředek M&T TITAN



**TIN-A**  
titan mosaz mat

Fyzikálně naprašovaný povrch s ne náhodnou podobností s přírodní mosaznou klikou, dříve ve velké míře používanou a u M&T znovu zařazenou do nabídky. Žluto/zlatý odstín je nadstandardním řešením všude tam, kde je požadavek na sladění celku v barvě mosazi, či zlata.

- termín výroby .. 4 - 8 týdnů
- záruka .. 15 let
- použití .. interiéry i exteriéry
- údržba .. prostředek M&T TITAN
- množstevní podmínka .. pouze pro zakázky nad 50 párů kování, případně od 1 páru s termínem dodání 3 - 6 měsíců



**TIN-S**  
titan bronz mat

Fyzikálně naprašovaný povrch požadovaný všude tam, kde je důraz na tradici, souznění se dřevem, popř. jinými přírodními materiály, dodávající realizaci patřičný genius loci.

- termín výroby .. 4 - 8 týdnů
- záruka .. 15 let
- použití .. interiéry i exteriéry
- údržba .. prostředek M&T TITAN
- množstevní podmínka .. pouze pro zakázky nad 50 párů kování, případně od 1 páru s termínem dodání 3 - 6 měsíců



**TIN-M**  
titan měď broušeno

Fyzikálně naprašovaný povrch s předúpravou - ručně broušenou 3D strukturou. Měděný odolný povrch vhodný do interiéru i exteriéru.

- termín výroby .. 4 - 8 týdnů
- záruka .. 15 let
- použití .. interiéry i exteriéry
- údržba .. prostředek M&T TITAN
- množstevní podmínka .. pouze pro zakázky nad 50 párů kování, případně od 1 páru s termínem dodání 3 - 6 měsíců



**TIN-B**  
titan braun mat

Fyzikálně naprašovaný povrch vyvinut speciálně pro řadu kování DESIGN 2009. Mění se povrch přecházející přes spektrum hnědých odstínů a končící na hranách klik až u hluboké tmavé barvy lze jen těžko definovat. Od uvedení na trh v roce 2009 si získává stále větší oblibu převážně u architektů a zakazníků s citem pro pokročilý design.

- termín výroby .. 4 - 8 týdnů
- záruka .. 15 let
- použití .. interiéry i exteriéry
- údržba .. prostředek M&T TITAN
- množstevní podmínka .. pouze pro zakázky nad 50 párů kování, případně od 1 páru s termínem dodání 3 - 6 měsíců

## Povrchy TiN

Jedinečné povrchy vznikající fyzikálním naprašováním plazmovým výbojem zaručující rovnoměrnou tenkou tvrdou vrstvou na povrchu výrobků, jsou zárukou té nejvyšší kvality na kování M&T. Nejedná se o barvu, lak, elox, ale o metalickou kovovou vrstvu ze speciálních materiálů, v různých odstínech. Jednotlivé odstíny nelze zatřídit do stupnic RAL, popř. do jiných stupnic barevnosti. Pod různým úhlem, pod různým osvětlením, pod různou intenzitou se odstíny vždy mění .. jedno jim však zůstává – pořád jsou výjimečné.

Tenká vrstva 2 µm má několik předností, díky kterým je tak výjimečná:

- Mimořádná tvrdost** .. 7× tvrdší než kliky s ochranným vypalovaným lakem
- Vysoká odolnost proti oděru a poškrábání** .. nelze poškodit/poškrábat při běžném používání
- Barevnostní a chemická stálost** .. povrch ani po mnoha letech nemění původní barevný odstín
- Korozní odolnost** .. kvalitně nanášené povlaky jsou jen nepatrně mikroporézní, což zabraňuje průniku malých částic k materiálu kliky a tím tvorbě koroze.



**Wh**  
bílá mat

Stříkaný vypalovaný povrch v odstínu RAL 9003, matný. Stříkaný povrch má své limity – nejedná se o kovovou vrstvu jako u všech dalších povrchů M&T. U povrchu nelze garantovat odolnost proti poškrábání prstýnkou, nebo jinými ostrými předměty. Povrch není vhodný do komerčních prostor a ke dveřím s vysokou frekvencí ovládání.

- termín výroby .. 4 - 8 týdnů
- záruka .. 2 roky, bez záruky proti poškrábání ostrými předměty
- použití .. interiéry s nízkou frekvencí ovládání
- údržba .. navlhčený bavlněný hadřík





**Ms**  
mosaz natural

Mechanicky upravený povrch na mosazném výrobku s jemnou strukturou a barevností, která se citlivě doplňuje s přírodním dřevem ať původním nebo moderním strukturovaným. Povrch bude přirozeně stárnout s okolním materiálem a měnit svoji barevnost podle klimatických podmínek. Skvělá investice s doživotní zárukou.

- termín výroby .. 3 - 4 týdny
- záruka .. doživotní !
- použití .. interiéry i exteriéry
- údržba .. bezúdržbové, bavlněný hadřík, popř. prostředek SITOL



**Ms-L**  
mosaz leštěno

Mechanicky ručně leštěný povrch na mosazném výrobku s vysoce lesklým povrchem, který postupně získává patinu a matovává. Povrch přirozeně stárne a mění svoji barevnost a vzhled i podle frekvence otevírání – na frekventovaných místech zůstane lesklý, jinde bude matný s tmavším odstínem. Každý kus je originál s jiným procesem stárnutí a jinou vzhledovou barevností. Skvělá investice s doživotní zárukou.

- termín výroby .. 3 - 4 týdny
- záruka .. doživotní !
- použití .. interiéry i exteriéry
- údržba .. bezúdržbové, bavlněný hadřík, popř. prostředek SITOL



**Ms-A**  
mosaz antik

Technologicky upravený povrch na mosazném výrobku s efektem několika let používané mosazi, tzn. žlutá mosaz je místy tmavá, místy světlejší s efektem „osáhané“ mosazi. Povrch bude dál přirozeně stárnout s okolním materiálem a měnit svoji barevnost podle klimatických podmínek. Skvělá investice s doživotní zárukou.

- termín výroby .. 4 - 8 týdnů
- záruka .. doživotní !
- použití .. interiéry i exteriéry
- údržba .. bezúdržbové, bavlněný hadřík, popř. prostředek SITOL



**Ms-D**  
mosaz staré dřevo

Technologicky upravený povrch na mosazném výrobku s efektem starého dřeva, ručně broušenou 3D strukturou. Skvělá investice s doživotní zárukou.

- termín výroby .. 4 - 8 týdnů
- záruka .. doživotní !
- použití .. interiéry i exteriéry
- údržba .. bezúdržbové, bavlněný hadřík, popř. prostředek SITOL



**Cr**  
lesklý chrom

Galvanické pokovení na mosazný výrobek s vysoce lesklým povrchem.

- termín výroby .. 3 - 4 týdny
- záruka .. 3 roky
- použití .. interiéry i exteriéry
- údržba .. bavlněný hadřík, popř. prostředek SITOL



**SNI**  
matný nikl

Galvanické pokovení na mosazný výrobek se sametově jemným povrchem.

- termín výroby .. 2 - 4 týdny
- záruka .. 3 roky
- použití .. interiéry
- údržba .. prostředek M&T SNI čistič nebo SITOL



**SNI-broušeno**  
matný nikl broušený

Galvanické pokovení na mosazný výrobek s ručně broušeným povrchem.

- termín výroby .. 2 - 4 týdny
- záruka .. 3 roky
- použití .. interiéry
- údržba .. prostředek M&T SNI čistič nebo SITOL



**TiN-C**  
titan chrom mat

Fyzikálně naprašovaný povrch s nejširším využitím, který díky svému ocelově šedo/modrému kovovému odstínu, dokáže najít využití v širokém spektru staveb a projektů s důrazem na prvotřídní kvalitu a design. Tento povrch je zároveň nejtvrdějším a nejodolnějším povrchem z celé nabídky titanových povrchů a tím je přímo předurčen pro použití v exteriérech a maximálně zatěžovaných prostorech.

- termín výroby .. 4 - 8 týdnů
- záruka .. 15 let
- použití .. interiéry i exteriéry
- údržba .. prostředek M&T TITAN



**NRz**  
nerez - broušeno

Mechanicky ručně broušený povrch na nerezovém výrobku s jemnou broušenou strukturou.

- termín výroby .. 7 pracovních dnů pro rozetové kování, ostatní sortiment nerez 3 - 4 týdny
- záruka .. 5 let
- použití .. interiéry i exteriéry
- údržba .. bezúdržbová, popř. prostředek M&T TITAN

## Údržba a ochrana klik

Kliky nenechávejte vlhké (převážně v koupelnách a na toaletách). Z odpařované vody se na povrchu klik vysrážejí a po té zůstávají minerální soli, které způsobují skvrny odlišné barvy. Tyto nečistoty lze účinně odstranit vygumováním školní gumou, nebo použitím univerzálního čisticího přípravku SITOL. Pro povrch SNI je vhodný přípravek **M&T SNI čistič**. Předcházejte těmto skvrnám a udržujte kliky suché.

Kliky s titanovým povrchem před prvním použitím lehce přetřete bavlněným hadříkem napuštěným ochranným přípravkem **M&T TITAN** .. po té již na klice nebudou viditelné otisky prstů a povrch získá sytější kovový odstín. Doporučujeme ochranný přípravek M&T TITAN zakoupit zároveň s titanovým kováním. Více informací na str. 371 Příslušenství a komponenty.

# POVRCHY KLIK

Představujeme Vám vyjimečné barevné kolekce tvrdých odolných kovových povrchů, technologicky velmi náročných na výrobu. Máte možnost výběru ve 4 atraktivních sériích BLACK, VINTAGE, BRASS, INDUSTRY. Využijte naše přednosti pro Vaši kreativitu.

## BLACK



Tmavé povrchy v působivých strukturách a odstínech. V každé výrobní sérii se odstíny mohou různit.

## VINTAGE



Fyzikálně napařované tvrdé kovové povrchy PVD. V každé výrobní sérii se odstíny mohou různit.

## BRASS



Přirodní materiál, povrch přirozeně stárne s okolním materiálem, tzn. matovatí, flekatí a tmavné. V každé výrobní sérii se odstíny mohou různit.

## INDUSTRY

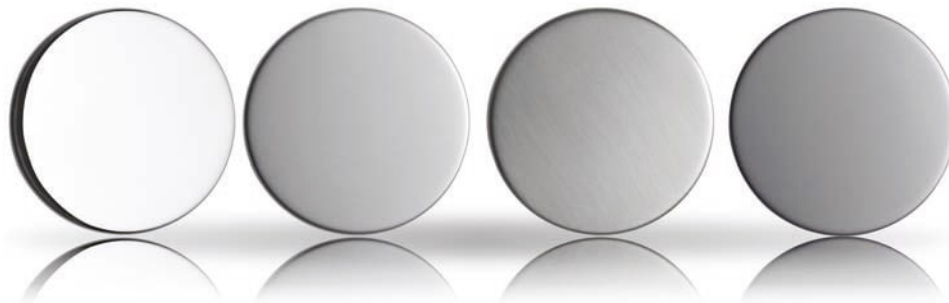

Odolné kovové povrchy v odstínech stříbrné a šedé. V každé výrobní sérii se odstíny mohou různit.

# VZORKOVNICE POVRCHŮ

Přehledná vzorkovnice všech povrchů a barev.

Kování M&T vyrábíme ze dvou kvalitních materiálů – nerezové oceli a masivní mosazi.

Každý materiál má svoje specifické vlastnosti, které nám umožňují připravit výrobky s finální povrchovou úpravou ve velké variabilitě pro maximální komfort zákazníků.

Objevte všechny možnosti, které Vám nabízíme a staňte se architekty svého vlastního projektu.



U každého povrchu máte přehledné informace o základním materiálu, výrobní technologii, termínu výroby, délce záruky, způsobu použití a údržbě.

Všechny důležité informace, které potřebujete znát, aby jste pečlivě zvolili ten správný výrobek pro Vaši plnou spokojenost.

Zjistíte, že naše nabídka je velmi rozsáhlá a uspokojí i nejnáročnější zákazníky.

Vzorkovnice povrchů by neměla chybět u žádného prodejce kování M&T ... EAN 030761, cena 2760 Kč bez DPH.

## Povrchy z masivní mosazi

VRACÍME SE O 100 LET ZPĚT A ZNOVU PRO VÁS OBJEVUJEME KRÁSU NATURÁLNÍ MOSAZI, MATERIÁLU S DOŽIVOTNÍ ZÁRUKOU, KTERÝ BUDE PŘIROZENĚ STÁRNOUT A MĚNIT SVOJI BARVU A CHARAKTER PODLE OKOLNÍHO PROSTORU A KLIMATICKÝCH PODMÍNEK

Od svého vzniku v roce 1997 vyrábíme kliky z masivní mosazi, které dokonale předupravujeme broušením a leštěním a po té ještě pokovujeme dalšími vrstvami různých kovů v různých barevných odstínech. I když jsou naše technologie na vysoké úrovni, všechny nanášené kovové vrstvy mají svoji životnost, která je omezená jejich tvrdostí a otěruvzdorností. Lidé si pomalu zvykají na mnoho produktů s omezenou zárukou a kratší a kratší životností, ale nemusí ...

„Připravili jsme pro Vás výrobky z materiálu s doživotní zárukou, s jednou výjimečnou vlastností - antimikrobiální účinností“



V MANUFAKTUŘE M&T V DOBRUŠCE

Je tady jedna cesta – tradiční, ale dokonalá, která už málem zapadla v zapomnění, ale my ji pomáháme oživit, protože je to cesta té nejvyšší kvality s doživotní zárukou. Ano, s doživotní zárukou. Použijeme kvalitní materiál masivní mosaz v naturálním stavu, kterou pouze mechanicky upravíme, tak jako naši předci před mnoha lety a dále už necháme materiál přirozeně stárnout, stejným způsobem jako stárnou všechny mosazné výrobky na všech tradičních stavbách po celém světě.



MOSAZ LEŠTĚNO **Ms-L**

MOSAZ NATURAL **Ms**



MOSAZ ANTIK **Ms-A**



MOSAZ STARÉ DŘEVO **Ms-D**





**Ms-A** mosaz antik  
(proces urychleného stárnutí  
pro vzhled „dlouhodobě používané kliky“)



**Ms** mosaz natur  
(mechanicky upravený povrch s jemnou strukturou,  
která postupně tmavne)



**Ms-L** mosaz leštěno  
(ručně leštěný povrch do vysokého lesku, který postupně matoví  
a získává přirozenou patinu)



**Ms-D** mosaz staré dřeva  
(technologicky upravený povrch na mosazném výrobku  
s efektem starého dřeva, ručně broušenou 3D strukturou)



## Černá je in

ČERNÉ MATNÉ KLIKY S VYSOCE KVALITNÍM TITANOVÝM POVRCHEM JSME TECHNOLOGICKY A VÝROBNĚ OVLÁDLI UŽ V ROCE 2000, ALE TEPRVE NYNÍ ZAČÍNÁ BÝT TEN PRAVÝ BOOM TOHOTO UNIKÁTNÍHO POVRCHU

Neustále se snažíme inovovat naše výrobky a to je i jeden z důvodů proč již od roku 2000 aplikujeme na své produkty titanové povrchy. I přesto, že se jedná o velmi komplikovanou technologii s mnoha aspekty a požadavky na dokonalé předúpravy, můžeme říci, že tyto povrchy umíme na naše výrobky aplikovat ve více barevných odstínech technologií fyzikálního naprašování nízkotlakým plazmovým výbojem.

Tenká vrstva 2  $\mu\text{m}$  má několik předností, díky kterým je tak výjimečná. Především je to mimořádná tvrdost, vysoká odolnost proti oděru a poškrábání, barevná a chemická stálost, korozní odolnost. U těchto povrchů povlakuje speciálně zakázku po zakázce v dodacích termínech, které jsou součástí této výjimečné technologie s výrobou do max. 4 týdnů.

# TIN-K

„Černý matný titanový povrch a černý matný chrom je v současnosti nejprestižnějším možným designovým prvkem na produktech v interiéru i exteriéru“



TITAN ČERNÝ MAT **TIN-K**

Černá je kontrastem bílé a přesně to se od této barvy očekává v minimalistických interiérech i exteriérech, kde je kladen velký důraz na detail produktů mezi které patří svítidla, baterie a samozřejmě také dveřní kování. Není to ale pouze kombinace s bílou barvou, kde nachází černé matné kování uplatnění.

Velmi žádané jsou nyní přírodní dřevěné materiály právě s kombinací s černým matným povrchem. Nechte se inspirovat tímto povrchem, který má široké uplatnění ve všech projektech té nejvyšší kategorie.



TERRY TIN-K  
titan černý mat



MINIMAL II TIN-K  
titan černý mat



CESAN TIN-K  
titan černý mat



Magnetický zámek  
černý mat



MINIMAL TIN-K  
titan černý mat



**Entero**



**Burak**



**Entero**



**Entry**



**Nova**



**Mini-T**





**Mini-S**

## TIN-K

černý matný odolný kovový povrch



**Morgan**



**Cesan**



**Terry**



**Sogut**



**Maximal**



**Deny**



**Minimal**



**Sogut**

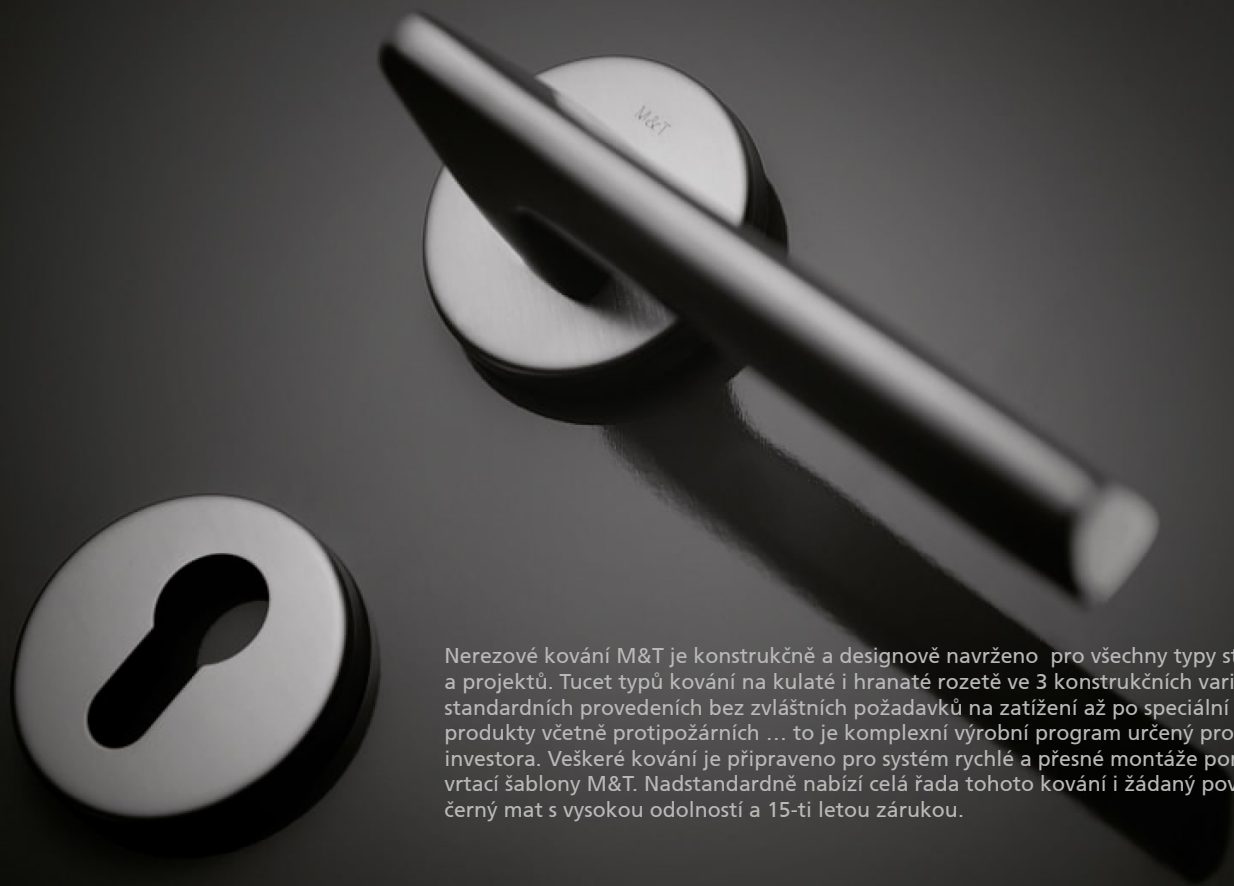

Nerezové kování M&T je konstrukčně a designově navrženo pro všechny typy staveb a projektů. Tucet typů kování na kulaté i hranaté rozetě ve 3 konstrukčních variantách od standardních provedeníh bez zvláštních požadavků na zatížení až po speciální projektové produkty včetně protipožárních ... to je komplexní výrobní program určený pro každého investora. Veškeré kování je připraveno pro systém rychlé a přesné montáže pomocí PROFÍ vrtací šablony M&T. Nadstandardně nabízí celá řada tohoto kování i žádaný povrch TiN-K titan černý mat s vysokou odolností a 15-ti letou zárukou.

Ochranná známka – registrovaná značka **ENTERO®**

Chráněné průmyslové vzory klik

**MORGAN  
TECHNO  
ENTERO  
SENZA  
PROMO  
NOVA**

Celý projekt - jeden design

Dveřní kliky NEREZ



Nerezové kliky, zámky a panty na skleněné dveře



Mušle na posuvné dveře



Okenní kliky 3 a 4 polohové



Štitové kování NEREZ



Madla dlouhá



Kování pro hliníkové a ocelové dveře, kování na branky



Bezpečnostní rozety



Madla a koule na skleněné a dřevěné dveře



## Dveřní kliky NEREZ

Materiál: nerezová ocel ANSI 304

Povrchy: NRz nerez - broušeno, TiN-K titan černý mat, K-industrial černý mat strukturovaný

LUSY NRz nerez ocel broušeno

MORGAN TiN-K titan černý mat

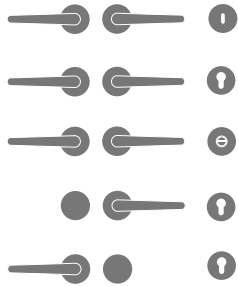
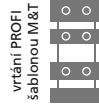

- Klika/klika + rozety kulaté dozické
- Klika/klika + rozety kulaté cylindrické
- Klika/klika + rozety kulaté WC
- Koule/klika R + rozety kulaté cylindrické
- Koule/klika L + rozety kulaté cylindrické

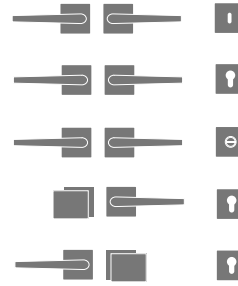

- Klika/klika + rozety čtvercové dozické
- Klika/klika + rozety čtvercové cylindrické
- Klika/klika + rozety čtvercové WC
- Madlo/klika R + rozety čtvercové cylindrické
- Madlo/klika L + rozety čtvercové cylindrické



rozety Ø 52 mm



rozety 52x52 mm

konstrukční varianty, materiálové provedení

koule Maty



koule Maty vyosená

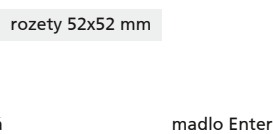

madlo Entero



### Economy

- kování s vratnou pružinou
- sada včetně spodních rozet
- sešroubování pouzdry proti sobě
- plastové podrozety
- vrtání PROFI šablonou M&T vrtákem Ø 6,4 mm
- animace montáže na [www.kliky-mt.cz/montaze-kovani](http://www.kliky-mt.cz/montaze-kovani)
- kategorie použití - třída 3
- záruka 5 let, titan 15 let
- montáž pro tloušťku dveří 38 - 126 mm
- v balení montážní materiál pro tl. dveří 38 - 45 mm

### Objekt

- kování s vratnou pružinou
- sada včetně spodních rozet s pouzdry
- sešroubování pouzdry proti sobě
- kovové podrozety u kliky
- zajišťovací gel proti uvolnění šroubů
- vrtání PROFI šablonou M&T vrtákem Ø 6,4 mm
- kategorie použití - třída 3
- záruka 5 let, titan 15 let
- montáž pro tloušťku dveří 38 - 126 mm
- v balení montážní materiál pro tl. dveří 38 - 45 mm

### Projekt tř. 4

- kování s vratnou pružinou
- sada včetně spodních rozet s pouzdry
- sešroubování pouzdry proti sobě
- kovové podrozety u kliky
- celonerezové provedení vč. krčku
- nerezový čtyřhran
- nerezový červík
- zajišťovací gel
- vrtání PROFI šablonou M&T vrtákem Ø 6,4 mm
- záruka 7 let, titan 15 let
- montáž pro tloušťku dveří 38 - 126 mm
- v balení montážní materiál pro tl. dveří 38 - 45 mm

Zatřídění kování podle normy EN 1906:2012, ČSN EN 1906 16 5776

Prohlášení o shodě na [www.kliky-mt.cz/certifikaty](http://www.kliky-mt.cz/certifikaty)

**Economy** **26-0030B**

**2** Kategorie použití .. střední frekvence používání lidmi, kteří jsou motivováni používat je pečlivě, ale kde je určitá pravděpodobnost nesprávného použití, např. vnitřní dveře kanceláří

**6** Životnost .. střední frekvence používání: 100 000 cyklů

**-** Hmotnost dveří .. (bez klasifikace)

**0** Požární odolnost .. (není požadována odolnost)

**0** Ochrana .. normální použití

**3** Odolnost proti korozi .. vysoká odolnost

**0** Bezpečnost .. odolnost není definována

**B** Typ ovládání .. kování s vratnou pružinou

**Objekt** **36-0031B**

**3** Kategorie použití .. vysoká frekvence používání veřejností nebo jinými uživateli s malou motivací o pečlivé používání a kde je vysoká pravděpodobnost nesprávného použití, např. dveře u veřejných kanceláří

**6** Životnost .. střední frekvence používání: 100 000 cyklů

**-** Hmotnost dveří .. (bez klasifikace)

**0** Požární odolnost .. (není požadována odolnost)

**0** Ochrana .. normální použití

**3** Odolnost proti korozi .. vysoká odolnost

**1** Bezpečnost .. mírná odolnost proti vloupání

**B** Typ ovládání .. kování s vratnou pružinou

**Projekt tř. 4** **47-D1141B**

**4** Kategorie použití .. vysoká frekvence používání na dveřích, které jsou předmětem častého hrubého používání, např. fotbalové stadiony, kasárna, veřejné toalety, atd.

**7** Životnost .. vysoká frekvence používání: 200 000 cyklů

**-** Hmotnost dveří .. (bez klasifikace)

**D1** Požární odolnost .. pro použití na kouřotěsných a požárně odolných dveřích s požadavky na speciální střed v klíče/knoflíku, zkušenných s 200000 cykly na zkušebních dveřích.

**1** Ochrana .. použití v situacích vyžadujících ochranu

**4** Odolnost proti korozi .. velmi vysoká odolnost

**1** Bezpečnost .. mírná odolnost proti vloupání

**B** Typ ovládání .. kování s vratnou pružinou



NRz nerez - broušeno

**Lusy**

590,- Kč  
25,- EUR



**Deny**

590,- Kč  
25,- EUR



**Meclis**

780,- Kč  
33,- EUR



**Morgan**

780,- Kč  
33,- EUR



**Jameson**

940,- Kč  
40,- EUR



**Nova**

1260,- Kč  
53,- EUR

TiN-K titan černý mat

**Economy nerez**  
materiál: nerezová ocel  
povrch: NRz nerez - broušeno

Kč			EUR
590,-			25,-
590,-			25,-
1020,-			43,-
1320,-			55,-
1320,-			55,-
590,-			25,-
590,-			25,-
1020,-			43,-
1320,-			55,-
1320,-			55,-
780,-			33,-
780,-			33,-
1260,-			53,-
1550,-			65,-
1550,-			65,-
780,-			33,-
780,-			33,-
1260,-			53,-
1550,-			65,-
1550,-			65,-
940,-			40,-
940,-			40,-
1400,-			59,-
1720,-			72,-
1720,-			72,-
1260,-			53,-
1260,-			53,-
1720,-			72,-
2030,-			85,-
2030,-			85,-

Provedení panikové pro zámky s děleným čtyřhranem je s příplatkem 220,- Kč (EAN 101416) k ceně cylindrického provedení. Dělený čtyřhran se objednává zvlášť a je třeba specifikovat přesnou délku čtyřhranu, str. 369.

Veškeré uváděné ceny v celém katalogu / ceníku jsou bez DPH.

		Economy nerez		Objekt nerez		Objekt titan		Objekt		Projekt tř. 4, (i protipožární)		Projekt tř. 4, (i protipožární)	
		NRz		NRz		TiN-K		K-industrial		NRz		TiN-K	
		cena / pár	EAN	cena / pár	EAN	cena / pár	EAN	cena / pár	EAN	cena / pár	EAN	cena / pár	EAN
dozické	Kč €	590,- 25,-	79861	880,- 37,-	39100	1180,- 50,-	013290	1180,- 50,-	030976	1180,- 50,-	013344	2190,- 92,-	013399
cyldrické	Kč €	590,- 25,-	79878	880,- 37,-	39117	1180,- 50,-	013306	1180,- 50,-	030983	1180,- 50,-	013351	2190,- 92,-	013405
WC	Kč €	1020,- 43,-	79885	1320,- 55,-	39124	1910,- 80,-	013313	1910,- 80,-	030990	1620,- 68,-	013368	2780,- 116,-	013412
koule / klika R	Kč €	1320,- 55,-	79892	1620,- 68,-	013276	2780,- 116,-	013320	2780,- 116,-	031003	1910,- 80,-	013375	3070,- 128,-	013429
koule / klika L	Kč €	1320,- 55,-	79908	1620,- 68,-	013283	2780,- 116,-	013337	2780,- 116,-	031010	1910,- 80,-	013382	3070,- 128,-	013436
dozické	Kč €	590,- 25,-	79960	880,- 37,-	013245	1180,- 50,-	013467	1180,- 50,-	031027	1180,- 50,-	013511	2190,- 92,-	013566
cyldrické	Kč €	590,- 25,-	79977	880,- 37,-	013252	1180,- 50,-	013474	1180,- 50,-	031034	1180,- 50,-	013528	2190,- 92,-	013573
WC	Kč €	1020,- 43,-	79984	1320,- 55,-	013269	1910,- 80,-	013481	1910,- 80,-	031041	1620,- 68,-	013535	2780,- 116,-	013580
koule / klika R	Kč €	1320,- 55,-	79991	1620,- 68,-	013443	2780,- 116,-	013498	2780,- 116,-	031058	1910,- 80,-	013542	3070,- 128,-	013597
koule / klika L	Kč €	1320,- 55,-	80003	1620,- 68,-	013450	2780,- 116,-	013504	2780,- 116,-	031065	1910,- 80,-	013559	3070,- 128,-	013603
dozické	Kč €	780,- 33,-	012545	1090,- 46,-	013610	2180,- 91,-	013665	2180,- 91,-	031072	1400,- 59,-	013719	2500,- 105,-	013764
cyldrické	Kč €	780,- 33,-	012552	1090,- 46,-	013627	2180,- 91,-	013672	2180,- 91,-	031089	1400,- 59,-	013726	2500,- 105,-	013771
WC	Kč €	1260,- 53,-	012569	1550,- 65,-	013634	2800,- 117,-	013689	2800,- 117,-	031096	1860,- 78,-	013733	3110,- 130,-	013788
koule / klika R	Kč €	1550,- 65,-	012576	1860,- 78,-	013641	3110,- 130,-	013696	3110,- 130,-	031102	2180,- 91,-	013740	3420,- 143,-	013795
koule / klika L	Kč €	1550,- 65,-	012583	1860,- 78,-	013658	3110,- 130,-	013702	3110,- 130,-	031119	2180,- 91,-	013757	3420,- 143,-	013801
dozické	Kč €	780,- 33,-	79915	1090,- 46,-	013818	1400,- 59,-	013863	1400,- 59,-	031126	1400,- 59,-	013917	2500,- 105,-	013962
cyldrické	Kč €	780,- 33,-	79922	1090,- 46,-	013825	1400,- 59,-	013870	1400,- 59,-	031133	1400,- 59,-	013924	2500,- 105,-	013979
WC	Kč €	1260,- 53,-	79939	1550,- 65,-	013832	2180,- 91,-	013887	2180,- 91,-	031140	1860,- 78,-	013931	3110,- 130,-	013986
koule / klika R	Kč €	1550,- 65,-	79946	1860,- 78,-	013849	3110,- 130,-	013894	3110,- 130,-	031157	2180,- 91,-	013948	3420,- 143,-	013993
koule / klika L	Kč €	1550,- 65,-	79953	1860,- 78,-	013856	3110,- 130,-	013900	3110,- 130,-	031164	2180,- 91,-	013955	3420,- 143,-	014006
dozické	Kč €	940,- 40,-	012590	1260,- 53,-	014013	1550,- 65,-	014068	1550,- 65,-	031171	1550,- 65,-	014112	2640,- 110,-	014167
cyldrické	Kč €	940,- 40,-	012606	1260,- 53,-	014020	1550,- 65,-	014075	1550,- 65,-	031188	1550,- 65,-	014129	2640,- 110,-	014174
WC	Kč €	1400,- 59,-	012613	1720,- 72,-	014037	2330,- 98,-	014082	2330,- 98,-	031195	2030,- 85,-	014136	3260,- 136,-	014181
koule / klika R	Kč €	1720,- 72,-	012620	2030,- 85,-	014044	3260,- 136,-	014099	3260,- 136,-	031201	2330,- 98,-	014143	3590,- 150,-	014198
koule / klika L	Kč €	1720,- 72,-	012637	2030,- 85,-	014051	3260,- 136,-	014105	3260,- 136,-	031218	2330,- 98,-	014150	3590,- 150,-	014204
dozické	Kč €	1260,- 53,-	012644	1550,- 65,-	014211	2640,- 110,-	014266	2640,- 110,-	031225	1860,- 78,-	014310	2950,- 123,-	014365
cyldrické	Kč €	1260,- 53,-	012651	1550,- 65,-	014228	2640,- 110,-	014273	2640,- 110,-	031232	1860,- 78,-	014327	2950,- 123,-	014372
WC	Kč €	1720,- 72,-	012668	2030,- 85,-	014235	3260,- 136,-	014280	3260,- 136,-	031249	2330,- 98,-	014334	3590,- 150,-	014389
koule / klika R	Kč €	2030,- 85,-	012675	2330,- 98,-	014242	3590,- 150,-	014297	3590,- 150,-	031256	2640,- 110,-	014341	3880,- 162,-	014396
koule / klika L	Kč €	2030,- 85,-	012682	2330,- 98,-	014259	3590,- 150,-	014303	3590,- 150,-	031263	2640,- 110,-	014358	3880,- 162,-	014402

U kombinace koule / klika dodáváme standardně kouli Maty pevnou - neočnou. Na základě požadavku kouli Maty vyosenou pevnou - neočnou s příplatkem 150,- Kč z Maloobchodního ceníku. V balení je standardně montážní materiál pro tl. dveří 38 - 45 mm. Pro větší tloušťky dveří je potřeba specifikovat jiný montážní materiál viz. Příslušenství a komponenty str. 368. U řady kování Objekt a Projekt tř. 4 jsou spodní rozety standardně s pouzdrý pro rychlou a přesnou montáž.



NRz nerez - broušeno

**Senza**

1260,- Kč  
53,- EUR



**Promo**

1400,- Kč  
59,- EUR



**Entero**

1720,- Kč  
72,- EUR



**Kvadra**

1400,- Kč  
59,- EUR



**Techno**

1260,- Kč  
53,- EUR



**Cesan**

1090,- Kč  
46,- EUR

**Economy nerez**

materiál: nerezová ocel

Kč povrch: NRz nerez - broušeno EUR

1260,- 53,-

1260,- 53,-

1720,- 72,-

2030,- 85,-

2030,- 85,-

1400,- 59,-

1400,- 59,-

1860,- 78,-

2180,- 91,-

2180,- 91,-

**Objekt nerez**

1720,- 72,-

1720,- 72,-

2180,- 91,-

2500,- 105,-

2500,- 105,-

1400,- 59,-

1400,- 59,-

1860,- 78,-

2180,- 91,-

2180,- 91,-

1260,- 53,-

1260,- 53,-

1720,- 72,-

2030,- 85,-

2030,- 85,-

1090,- 46,-

1090,- 46,-

1550,- 65,-

1860,- 78,-

1860,- 78,-

320,- 14,-

Provedení panikové pro zámky s děleným čtyřhranem je s příplatkem 220,- Kč (EAN 101416) k ceně cylindrického provedení. Dělený čtyřhran se objednává zvlášť a je třeba specifikovat přesnou délku čtyřhranu, str. 368. Kliku Kvadra a Promo nelze dodat v panikovém provedení.



		Economy nerez		Objekt nerez		Objekt titan		Objekt		Projekt tř. 4, (i protipožární)		Projekt tř. 4, (i protipožární)	
		NRz		NRz		TiN-K		K-industrial		NRz		TiN-K	
		cena / pár	EAN	cena / pár	EAN	cena / pár	EAN	cena / pár	EAN	cena / pár	EAN	cena / pár	EAN
dozické	Kč €	1260,- 53,-	012699	1550,- 65,-	014419	2260,- 95,-	170047	2260,- 95,-	031270	1860,- 78,-	014518	2920,- 122,-	170146
cylinrické	Kč €	1260,- 53,-	012705	1550,- 65,-	014426	2260,- 95,-	170054	2260,- 95,-	031287	1860,- 78,-	014525	2920,- 122,-	170153
WC	Kč €	1720,- 72,-	012712	2030,- 85,-	014433	2800,- 117,-	170061	2800,- 117,-	031294	2330,- 98,-	014532	3410,- 143,-	170160
koule / klika R	Kč €	2030,- 85,-	012729	2330,- 98,-	014440	3060,- 128,-	170078	3060,- 128,-	031300	2640,- 110,-	014549	3730,- 156,-	170177
koule / klika L	Kč €	2030,- 85,-	012736	2330,- 98,-	014457	3060,- 128,-	170085	3060,- 128,-	031317	2640,- 110,-	014556	3730,- 156,-	170184
dozické	Kč €	1400,- 59,-	012743	1720,- 72,-	014617	2400,- 100,-	170092	2400,- 100,-	031324	2030,- 85,-	014716	3110,- 130,-	170191
cylinrické	Kč €	1400,- 59,-	012750	1720,- 72,-	014624	2400,- 100,-	170108	2400,- 100,-	031331	2030,- 85,-	014723	3110,- 130,-	170207
WC	Kč €	1860,- 78,-	012767	2180,- 91,-	014631	2930,- 123,-	170115	2930,- 123,-	031348	2500,- 105,-	014730	3730,- 156,-	170214
koule / klika R	Kč €	2180,- 91,-	012774	2500,- 105,-	014648	3200,- 134,-	170122	3200,- 134,-	031355	2800,- 117,-	014747	4040,- 169,-	170221
koule / klika L	Kč €	2180,- 91,-	012781	2500,- 105,-	014655	3200,- 134,-	170139	3200,- 134,-	031362	2800,- 117,-	014754	4040,- 169,-	170238
dozické	Kč €			1720,- 72,-	79816	2800,- 117,-	014815	2800,- 117,-	138306	2030,- 85,-	014860	3110,- 130,-	014914
cylinrické	Kč €			1720,- 72,-	79823	2800,- 117,-	014822	2800,- 117,-	138313	2030,- 85,-	014877	3110,- 130,-	014921
WC	Kč €			2180,- 91,-	79830	3420,- 143,-	014839	3420,- 143,-	138320	2500,- 105,-	014884	3730,- 156,-	014938
koule / klika R	Kč €			2500,- 105,-	79847	3730,- 156,-	014846	3730,- 156,-	138337	2800,- 117,-	014891	4040,- 169,-	014945
koule / klika L	Kč €			2500,- 105,-	79854	3730,- 156,-	014853	3730,- 156,-	138344	2800,- 117,-	014907	4040,- 169,-	014952
dozické	Kč €	1400,- 59,-	012798	1720,- 72,-	014969	2800,- 117,-	015010	2800,- 117,-	031379	2030,- 85,-	015065	3110,- 130,-	015119
cylinrické	Kč €	1400,- 59,-	012804	1720,- 72,-	014976	2800,- 117,-	015027	2800,- 117,-	031386	2030,- 85,-	015072	3110,- 130,-	015126
WC	Kč €	1860,- 78,-	012811	2180,- 91,-	014983	3420,- 143,-	015034	3420,- 143,-	031393	2500,- 105,-	015089	3730,- 156,-	015133
koule / klika R	Kč €	2180,- 91,-	012828	2500,- 105,-	014990	3730,- 156,-	015041	3730,- 156,-	031409	2800,- 117,-	015096	4040,- 169,-	015140
koule / klika L	Kč €	2180,- 91,-	012835	2500,- 105,-	015003	3730,- 156,-	015058	3730,- 156,-	031416	2800,- 117,-	015102	4040,- 169,-	015157
dozické	Kč €	1260,- 53,-	012842	1550,- 65,-	015164			2260,- 95,-	031423	1860,- 78,-	015263		
cylinrické	Kč €	1260,- 53,-	012859	1550,- 65,-	015171			2260,- 95,-	031430	1860,- 78,-	015270		
WC	Kč €	1720,- 72,-	012866	2030,- 85,-	015188			2800,- 117,-	031447	2330,- 98,-	015287		
koule / klika R	Kč €	2030,- 85,-	012873	2330,- 98,-	015195			3060,- 128,-	031454	2640,- 110,-	015294		
koule / klika L	Kč €	2030,- 85,-	012880	2330,- 98,-	015201			3060,- 128,-	031461	2640,- 110,-	015300		
dozické	Kč €	1090,- 46,-	023398	1400,- 59,-	023442	2500,- 105,-	023497	2500,- 105,-	031478	1720,- 72,-	023541	2800,- 117,-	023596
cylinrické	Kč €	1090,- 46,-	023404	1400,- 59,-	023459	2500,- 105,-	023503	2500,- 105,-	031485	1720,- 72,-	023558	2800,- 117,-	023602
WC	Kč €	1550,- 65,-	023411	1860,- 78,-	023466	3110,- 130,-	023510	3110,- 130,-	031492	2180,- 91,-	023565	3420,- 143,-	023619
koule / klika R	Kč €	1860,- 78,-	023428	2180,- 91,-	023473	3420,- 143,-	023527	3420,- 143,-	031508	2500,- 105,-	023572	3730,- 156,-	023626
koule / klika L	Kč €	1860,- 78,-	023435	2180,- 91,-	023480	3420,- 143,-	023534	3420,- 143,-	031515	2500,- 105,-	023589	3730,- 156,-	023633
rozeta zaslepovací	Kč €	320,- 14,-	024135			630,- 27,-	024142	630,- 27,-	031522	Veškeré ceny v ceníku jsou bez DPH.			



TiN-K titan černý mat

**Lusy**

730,- Kč  
31,- EUR



NRz nerez - broušeno

**Deny**

730,- Kč  
31,- EUR



**Meclis**

1090,- Kč  
46,- EUR



**Morgan**

1090,- Kč  
46,- EUR



**Jameson**

1260,- Kč  
53,- EUR



**Nova**

1550,- Kč  
65,- EUR

**Economy nerez**

materiál: nerezová ocel

Kč povrch: NRz nerez - broušeno EUR

Kč			EUR
730,-			31,-
730,-			31,-
1260,-			53,-
1620,-			68,-
1620,-			68,-
730,-			31,-
730,-			31,-
1260,-			53,-
1620,-			68,-
1620,-			68,-
1090,-			46,-
1090,-			46,-
1650,-			69,-
2030,-			85,-
2030,-			85,-
1090,-			46,-
1090,-			46,-
1650,-			69,-
2030,-			85,-
2030,-			85,-
1260,-			53,-
1260,-			53,-
1820,-			76,-
2180,-			91,-
2180,-			91,-
1550,-			65,-
1550,-			65,-
2110,-			88,-
2500,-			105,-
2500,-			105,-

Provedení panikové pro zámky s děleným čtyřhranem je s příplatkem 220,- Kč (EAN 101416) k ceně cylindrického provedení. Dělený čtyřhran se objednává zvlášť a je třeba specifikovat přesnou délku čtyřhranu, str. 369.

		Economy nerez		Objekt nerez		Objekt titan		Objekt		Projekt tř. 4, (i protipožární)		Projekt tř. 4, (i protipožární)	
		NRz		NRz		TiN-K		K-industrial		NRz		TiN-K	
		cena / pár	EAN	cena / pár	EAN	cena / pár	EAN	cena / pár	EAN	cena / pár	EAN	cena / pár	EAN
dozické	Kč €	730,- 31,-	79663	1020,- 43,-	39131	1320,- 55,-	015386	1320,- 55,-	031539	1320,- 55,-	015430	2350,- 98,-	015485
cyldrické	Kč €	730,- 31,-	79670	1020,- 43,-	39148	1320,- 55,-	015393	1320,- 55,-	031546	1320,- 55,-	015447	2350,- 98,-	015492
WC	Kč €	1260,- 53,-	79687	1550,- 65,-	39155	2190,- 92,-	015409	2190,- 92,-	031553	1850,- 78,-	015454	3020,- 126,-	015508
madlo / klika R	Kč €	1620,- 68,-	79694	1910,- 80,-	015362	3070,- 128,-	015416	3070,- 128,-	031560	2190,- 92,-	015461	3380,- 141,-	015515
madlo / klika L	Kč €	1620,- 68,-	79700	1910,- 80,-	015379	3070,- 128,-	015423	3070,- 128,-	031577	2190,- 92,-	015478	3380,- 141,-	015522
dozické	Kč €	730,- 31,-	79762	1020,- 43,-	015539	1320,- 55,-	015584	1320,- 55,-	031584	1320,- 55,-	015638	2350,- 98,-	015683
cyldrické	Kč €	730,- 31,-	79779	1020,- 43,-	015546	1320,- 55,-	015591	1320,- 55,-	031591	1320,- 55,-	015645	2350,- 98,-	015690
WC	Kč €	1260,- 53,-	79786	1550,- 65,-	015553	2190,- 92,-	015607	2190,- 92,-	031607	1850,- 78,-	015652	3020,- 126,-	015706
madlo / klika R	Kč €	1620,- 68,-	79793	1910,- 80,-	015560	3070,- 128,-	015614	3070,- 128,-	031614	2190,- 92,-	015669	3380,- 141,-	015713
madlo / klika L	Kč €	1620,- 68,-	79809	1910,- 80,-	015577	3070,- 128,-	015621	3070,- 128,-	031621	2190,- 92,-	015676	3380,- 141,-	015720
dozické	Kč €	1090,- 46,-	012897	1400,- 59,-	015737	2500,- 105,-	015782	2500,- 105,-	031638	1720,- 72,-	015836	2800,- 117,-	015881
cyldrické	Kč €	1090,- 46,-	012903	1400,- 59,-	015744	2500,- 105,-	015799	2500,- 105,-	031645	1720,- 72,-	015843	2800,- 117,-	015898
WC	Kč €	1650,- 69,-	012910	1970,- 83,-	015751	3210,- 134,-	015805	3210,- 134,-	031652	2270,- 95,-	015850	3510,- 147,-	015904
madlo / klika R	Kč €	2030,- 85,-	012927	2330,- 98,-	015768	3590,- 150,-	015812	3590,- 150,-	031669	2640,- 110,-	015867	3880,- 162,-	015911
madlo / klika L	Kč €	2030,- 85,-	012934	2330,- 98,-	015775	3590,- 150,-	015829	3590,- 150,-	031676	2640,- 110,-	015874	3880,- 162,-	015928
dozické	Kč €	1090,- 46,-	79717	1400,- 59,-	39162	1550,- 65,-	015959	1550,- 65,-	031683	1720,- 72,-	016000	2800,- 117,-	016055
cyldrické	Kč €	1090,- 46,-	79724	1400,- 59,-	39179	1550,- 65,-	015966	1550,- 65,-	031690	1720,- 72,-	016017	2800,- 117,-	016062
WC	Kč €	1650,- 69,-	79731	1970,- 83,-	39186	2500,- 105,-	015973	2500,- 105,-	031706	2270,- 95,-	016024	3510,- 147,-	016079
madlo / klika R	Kč €	2030,- 85,-	79748	2330,- 98,-	015935	3590,- 150,-	015980	3590,- 150,-	031713	2640,- 110,-	016031	3880,- 162,-	016086
madlo / klika L	Kč €	2030,- 85,-	79755	2330,- 98,-	015942	3590,- 150,-	015997	3590,- 150,-	031720	2640,- 110,-	016048	3880,- 162,-	016093
dozické	Kč €	1260,- 53,-	012941	1550,- 65,-	016109	1720,- 72,-	016154	1720,- 72,-	031737	1860,- 78,-	016208	2950,- 123,-	016253
cyldrické	Kč €	1260,- 53,-	012958	1550,- 65,-	016116	1720,- 72,-	016161	1720,- 72,-	031744	1860,- 78,-	016215	2950,- 123,-	016260
WC	Kč €	1820,- 76,-	012965	2110,- 88,-	016123	2640,- 110,-	016178	2640,- 110,-	031751	2430,- 102,-	016222	3660,- 153,-	016277
madlo / klika R	Kč €	2180,- 91,-	012972	2500,- 105,-	016130	3730,- 156,-	016185	3730,- 156,-	031768	2800,- 117,-	016239	4040,- 169,-	016284
madlo / klika L	Kč €	2180,- 91,-	012989	2500,- 105,-	016147	3730,- 156,-	016192	3730,- 156,-	031775	2800,- 117,-	016246	4040,- 169,-	016291
dozické	Kč €	1550,- 65,-	012996	1860,- 78,-	016307	2950,- 123,-	016352	2950,- 123,-	031782	2180,- 91,-	016406	3260,- 136,-	016451
cyldrické	Kč €	1550,- 65,-	013009	1860,- 78,-	016314	2950,- 123,-	016369	2950,- 123,-	031799	2180,- 91,-	016413	3260,- 136,-	016468
WC	Kč €	2110,- 88,-	013016	2430,- 102,-	016321	3660,- 153,-	016376	3660,- 153,-	031805	2740,- 115,-	016420	3980,- 166,-	016475
madlo / klika R	Kč €	2500,- 105,-	013023	2800,- 117,-	016338	4040,- 169,-	016383	4040,- 169,-	031812	3110,- 130,-	016437	4350,- 182,-	016482
madlo / klika L	Kč €	2500,- 105,-	013030	2800,- 117,-	016345	4040,- 169,-	016390	4040,- 169,-	031829	3110,- 130,-	016444	4350,- 182,-	016499

U kombinace madlo / klika dodáváme standardně madlo Entero pevné - neotočné.

V balení je standardně montážní materiál pro tl. dveří 38 - 45 mm. Pro větší tloušťky dveří je potřeba specifikovat jiný montážní materiál viz. Příslušenství a komponenty str. 368.

U řady kování Objekt a Projekt tř. 4 jsou spodní rozety standardně s pouzdry pro rychlou a přesnou montáž.



NRz nerez - broušeno

**Senza**

1400,- Kč  
59,- EUR



**Promo**

1550,- Kč  
65,- EUR



**Entero**

1860,- Kč  
78,- EUR



**Kvadra**

1550,- Kč  
65,- EUR



**Techno**

1550,- Kč  
65,- EUR



**Cesan**

1400,- Kč  
59,- EUR

**Economy nerez**

materiál: nerezová ocel

Kč povrch: NRz nerez - broušeno EUR

1400,-				59,-
1400,-				59,-
1970,-				83,-
2330,-				98,-
2330,-				98,-
1550,-				65,-
1550,-				65,-
2110,-				88,-
2500,-				105,-
2500,-				105,-
1860,-				78,-
1860,-				78,-
2430,-				102,-
2800,-				117,-
2800,-				117,-
1550,-				65,-
1550,-				65,-
2110,-				88,-
2500,-				105,-
2500,-				105,-
1550,-				65,-
1550,-				65,-
2110,-				88,-
2500,-				105,-
2500,-				105,-
1400,-				59,-
1400,-				59,-
1970,-				83,-
2330,-				98,-
2330,-				98,-
400,-				17,-

Provedení panikové pro zámky s děleným čtyřhranem je s příplatkem 220,- Kč (EAN 101416) k ceně cylindrického provedení. Dělený čtyřhran se objednává zvlášť a je třeba specifikovat přesnou délku čtyřhranu, str. 368. Kliku Kvadra a Promo nelze dodat v panikovém provedení.

		Economy nerez		Objekt nerez		Objekt titan		Objekt		Projekt tř. 4, (i protipožární)		Projekt tř. 4, (i protipožární)	
		NRz		NRz		TiN-K		K-industrial		NRz		TiN-K	
		cena / pár	EAN	cena / pár	EAN	cena / pár	EAN	cena / pár	EAN	cena / pár	EAN	cena / pár	EAN
dozické	Kč €	1400,- 59,-	013047	1720,- 72,-	016505	2800,- 117,-	170245	2800,- 117,-	031836	2030,- 85,-	016604	3110,- 130,-	170344
cyldrické	Kč €	1400,- 59,-	013054	1720,- 72,-	016512	2800,- 117,-	170252	2800,- 117,-	031843	2030,- 85,-	016611	3110,- 130,-	170351
WC	Kč €	1970,- 83,-	013061	2270,- 95,-	016529	3320,- 139,-	170269	3320,- 139,-	031850	2590,- 108,-	016628	3670,- 153,-	170368
madlo / klika R	Kč €	2330,- 98,-	013078	2640,- 110,-	016536	3600,- 150,-	170276	3600,- 150,-	031867	2950,- 123,-	016635	4190,- 175,-	170375
madlo / klika L	Kč €	2330,- 98,-	013085	2640,- 110,-	016543	3600,- 150,-	170283	3600,- 150,-	031874	2950,- 123,-	016642	4190,- 175,-	170382
dozické	Kč €	1550,- 65,-	013092	1860,- 78,-	016703	2950,- 123,-	170290	2950,- 123,-	031881	2180,- 91,-	016802	3260,- 136,-	170399
cyldrické	Kč €	1550,- 65,-	013108	1860,- 78,-	016710	2950,- 123,-	170306	2950,- 123,-	031898	2180,- 91,-	016819	3260,- 136,-	170405
WC	Kč €	2110,- 88,-	013115	2430,- 102,-	016727	3660,- 153,-	170313	3660,- 153,-	031904	2740,- 115,-	016826	3980,- 166,-	170412
madlo / klika R	Kč €	2500,- 105,-	013122	2800,- 117,-	016734	4040,- 169,-	170320	4040,- 169,-	031911	3110,- 130,-	016833	4350,- 182,-	170429
madlo / klika L	Kč €	2500,- 105,-	013139	2800,- 117,-	016741	4040,- 169,-	170337	4040,- 169,-	031928	3110,- 130,-	016840	4350,- 182,-	170436
dozické	Kč €			1860,- 78,-	79618	2950,- 123,-	016901	2950,- 123,-	138252	2180,- 91,-	016956	3260,- 136,-	017007
cyldrické	Kč €			1860,- 78,-	79625	2950,- 123,-	016918	2950,- 123,-	138269	2180,- 91,-	016963	3260,- 136,-	017014
WC	Kč €			2430,- 102,-	79632	3660,- 153,-	016925	3660,- 153,-	138276	2740,- 115,-	016970	3980,- 166,-	017021
madlo / klika R	Kč €			2800,- 117,-	79649	4040,- 169,-	016932	4040,- 169,-	138283	3110,- 130,-	016987	4350,- 182,-	017038
madlo / klika L	Kč €			2800,- 117,-	79656	4040,- 169,-	016949	4040,- 169,-	138290	3110,- 130,-	016994	4350,- 182,-	017045
dozické	Kč €	1550,- 65,-	013146	1860,- 78,-	017052	2950,- 123,-	017106	2950,- 123,-	031935	2180,- 91,-	017151	3260,- 136,-	017205
cyldrické	Kč €	1550,- 65,-	013153	1860,- 78,-	017069	2950,- 123,-	017113	2950,- 123,-	031942	2180,- 91,-	017168	3260,- 136,-	017212
WC	Kč €	2110,- 88,-	013160	2430,- 102,-	017076	3660,- 153,-	017120	3660,- 153,-	031959	2740,- 115,-	017175	3980,- 166,-	017229
madlo / klika R	Kč €	2500,- 105,-	013177	2800,- 117,-	017083	4040,- 169,-	017137	4040,- 169,-	031966	3110,- 130,-	017182	4350,- 182,-	017236
madlo / klika L	Kč €	2500,- 105,-	013184	2800,- 117,-	017090	4040,- 169,-	017144	4040,- 169,-	031973	3110,- 130,-	017199	4350,- 182,-	017243
dozické	Kč €	1550,- 65,-	013191	1860,- 78,-	017250			2950,- 123,-	031980	2180,- 91,-	017359		
cyldrické	Kč €	1550,- 65,-	013207	1860,- 78,-	017267			2950,- 123,-	031997	2180,- 91,-	017366		
WC	Kč €	2110,- 88,-	013214	2430,- 102,-	017274			3660,- 153,-	032000	2740,- 115,-	017373		
madlo / klika R	Kč €	2500,- 105,-	013221	2800,- 117,-	017281			4040,- 169,-	032017	3110,- 130,-	017380		
madlo / klika L	Kč €	2500,- 105,-	013238	2800,- 117,-	017298			4040,- 169,-	032024	3110,- 130,-	017397		
dozické	Kč €	1400,- 59,-	023640	1720,- 72,-	023695	2800,- 117,-	023749	2800,- 117,-	032031	2030,- 85,-	023794	3110,- 130,-	023848
cyldrické	Kč €	1400,- 59,-	023657	1720,- 72,-	023701	2800,- 117,-	023756	2800,- 117,-	032048	2030,- 85,-	023800	3110,- 130,-	023855
WC	Kč €	1970,- 83,-	023664	2270,- 95,-	023718	3510,- 147,-	023763	3510,- 147,-	032055	2590,- 108,-	023817	3830,- 160,-	023862
madlo / klika R	Kč €	2330,- 98,-	023671	2640,- 110,-	023725	3880,- 162,-	023770	3880,- 162,-	032062	2950,- 123,-	023824	4190,- 175,-	023879
madlo / klika L	Kč €	2330,- 98,-	023688	2640,- 110,-	023732	3880,- 162,-	023787	3880,- 162,-	032079	2950,- 123,-	023831	4190,- 175,-	023886
rozeta zaslepovací	Kč €	400,- 17,-	024159			780,- 33,-	024166	780,- 33,-	032086				



NRz nerez - broušeno

**Hanna**

1260,- Kč  
53,- EUR



**Hanna**

1550,- Kč  
65,- EUR



**Sonia**

1090,- Kč  
46,- EUR



**Sonia**

1400,- Kč  
59,- EUR

**Economy nerez**  
materiál: nerezová ocel  
povrch: NRz nerez - broušeno

Kč		EUR
1260,-		53,-
1260,-		53,-
1720,-		72,-
2030,-		85,-
2030,-		85,-
<hr/>		
1550,-		65,-
1550,-		65,-
2110,-		88,-
2500,-		105,-
2500,-		105,-

**Economy nerez**  
materiál: nerezová ocel  
povrch: NRz nerez - broušeno

Kč		EUR
1090,-		46,-
1090,-		46,-
1550,-		65,-
1860,-		78,-
1860,-		78,-
<hr/>		
1400,-		59,-
1400,-		59,-
1970,-		83,-
2330,-		98,-
2330,-		98,-

		Economy nerez		Objekt nerez		Objekt titan		Objekt		Projekt tř. 4, (i protipožární)		Projekt tř. 4, (i protipožární)	
		NRz		NRz		TiN-K		K-industrial		NRz		TiN-K	
		cena / pár	EAN	cena / pár	EAN	cena / pár	EAN	cena / pár	EAN	cena / pár	EAN	cena / pár	EAN
dozické	Kč €	1260,- 53,-	046762	1550,- 65,-	046892	2640,- 110,-	104769	2640,- 110,-	138351	1860,- 78,-	081800	2950,- 123,-	104813
cylindrické	Kč €	1260,- 53,-	046779	1550,- 65,-	046908	2640,- 110,-	104776	2640,- 110,-	138368	1860,- 78,-	081817	2950,- 123	104820
WC	Kč €	1720,- 72,-	046786	2030,- 85,-	046915	3260,- 136,-	104783	3260,- 136,-	138375	2330,- 98,-	081824	3590,- 150,-	104837
koule / klika R	Kč €	2030,- 85,-	046793	2330,- 98,-	046922	3590,- 150,-	104790	3590,- 150,-	138382	2640,- 110,-	081831	3880,- 162,-	104844
koule / klika L	Kč €	2030,- 85,-	046809	2330,- 98,-	046939	3590,- 150,-	104806	3590,- 150,-	138399	2640,- 110,-	081848	3880,- 162,-	104943
dozické	Kč €	1550,- 65,-	046816	1860,- 78,-	046946	2950,- 123,-	104950	2950,- 123,-	138405	2180,- 91,-	081855	3260,- 136,-	105001
cylindrické	Kč €	1550,- 65,-	046823	1860,- 78,-	046953	2950,- 123,-	104967	2950,- 123,-	138412	2180,- 91,-	081862	3260,- 136,-	105018
WC	Kč €	2110,- 88,-	046830	2430,- 102,-	046960	3660,- 153,-	104974	3660,- 153,-	138429	2740,- 115,-	081879	3980,- 166,-	105025
madlo / klika R	Kč €	2500,- 105,-	046847	2800,- 117,-	046977	4040,- 169,-	104981	4040,- 169,-	138436	3110,- 130,-	081886	4350,- 182,-	082029
madlo / klika L	Kč €	2500,- 105,-	046854	2800,- 117,-	046984	4040,- 169,-	104998	4040,- 169,-	138443	3110,- 130,-	081893	4350,- 182,-	082036

U kombinace koule / klika dodáváme standardně kouli Maty pevnou - neočnou. Na základě požadavku kouli Maty vyosenou pevnou - neočnou s příplatkem 150,- Kč z Maloobchodního ceníku. V balení je standardně montážní materiál pro tl. dveří 38 - 45 mm. Pro větší tloušťky dveří je potřeba specifikovat jiný montážní materiál viz. Příslušenství a komponenty str. 368.  
U řady kování Objekt a Projekt tř. 4 jsou spodní rozety standardně s pouzdry pro rychlou a přesnou montáž.

		Economy nerez		Objekt nerez		Objekt titan		Objekt		Projekt tř. 4, (i protipožární)		Projekt tř. 4, (i protipožární)	
		NRz		NRz		TiN-K		K-industrial		NRz		TiN-K	
		cena / pár	EAN	cena / pár	EAN	cena / pár	EAN	cena / pár	EAN	cena / pár	EAN	cena / pár	EAN
dozické	Kč €	1090,- 46,-	102734	1400,- 59,-	102789	2500,- 105,-	102833	2500,- 105,-	138450	1720,- 72,-	102888	2800,- 117,-	102932
cylindrické	Kč €	1090,- 46,-	102741	1400,- 59,-	102796	2500,- 105,-	102840	2500,- 105,-	138467	1720,- 72,-	102895	2800,- 117,-	102949
WC	Kč €	1550,- 65,-	102758	1860,- 78,-	102802	3110,- 130,-	102857	3110,- 130,-	138474	2180,- 91,-	102901	3420,- 143,-	102956
koule / klika R	Kč €	1860,- 78,-	102765	2180,- 91,-	102819	3420,- 143,-	102864	3420,- 143,-	138481	2500,- 105,-	102918	3730,- 156,-	102963
koule / klika L	Kč €	1860,- 78,-	102772	2180,- 91,-	102826	3420,- 143,-	102871	3420,- 143,-	138498	2500,- 105,-	102925	3730,- 156,-	102970
dozické	Kč €	1400,- 59,-	102987	1720,- 72,-	103038	2800,- 117,-	103083	2800,- 117,-	138504	2030,- 85,-	103137	3110,- 130,-	103182
cylindrické	Kč €	1400,- 59,-	102994	1720,- 72,-	103045	2800,- 117,-	103090	2800,- 117,-	138511	2030,- 85,-	103144	3110,- 130,-	103199
WC	Kč €	1970,- 83,-	103007	2270,- 95,-	103052	3510,- 147,-	103106	3510,- 147,-	138528	2590,- 108,-	103151	3830,- 160,-	103205
madlo / klika R	Kč €	2330,- 98,-	103014	2640,- 110,-	103069	3880,- 162,-	103113	3880,- 162,-	138535	2950,- 123,-	103168	4190,- 175,-	103212
madlo / klika L	Kč €	2330,- 98,-	103021	2640,- 110,-	103076	3880,- 162,-	103120	3880,- 162,-	138542	2950,- 123,-	103175	4190,- 175,-	103229

U kombinace madlo / klika dodáváme standardně madlo Entero pevné - neoččné.  
V balení je standardně montážní materiál pro tl. dveří 38 - 45 mm. Pro větší tloušťky dveří je potřeba specifikovat jiný montážní materiál viz. Příslušenství a komponenty str. 368.  
U řady kování Objekt a Projekt tř. 4 jsou spodní rozety standardně s pouzdry pro rychlou a přesnou montáž.

# MAGNETICKÉ ROZETY

**SYSTÉM NEOXYM ULTRA MAGNET KONCEPT**  
rychlé, pevné, použitím nainstalovatelné dlouhodobě fluorektivní  
pořadové rozety k zajištění/vnitřní rozetě

ČTVERCOVÁ 54 x 54 mm

KULATÁ Ø 54 mm



**SYSTÉM PROŠROUBOVÁNÍ  
BEZ MOŽNOSTI PŮTOČENÍ ROZET**  
přetné naváděcí vložky/prouduče nasazené  
do předvrtaných otvorů ve dřevě či zbrnění  
jakémukoli pohybu celé konstrukce rozet

**SYSTÉM FIXACE ŠROUBU TUFLOX®**  
s odlehčeným nylonovým povlakem dlouhodobě  
garantuje stabilitu celé konstrukce bez možnosti  
samovolného uvolnění + nabízí další 4 jističí body  
pomocí samolepících vložek

**SYSTÉM 1. SPRING**  
optimální síly stlačení na šluk je dopraveno  
vratnou pružinou montážně připravenou  
pouze na jedné straně, dřík funkční  
zajišťuje druhé zámek

**SYSTÉM  
KLUZNYCH POUZDER**  
polymerová lamina/prouduče precizně vedou  
šluk v rozetě a dlouhodobě zajišťují jejich tlak  
a bezvadný chod

**SYSTÉM FIX M6**  
tlace šluk k ovládacímu číhému pomocí speciálně  
navrhovanému červku M6, kdy se celá dovedací plocha  
založí do připravené drážky, zhyfřtanu a tím znenáhla  
jakémukoli požadujícímu nechtěnému uvolnění šluk.  
S červkem dodávaná zajišťovací gel zabránívá  
samovolnému uvolnění

Mechanika 2018  
**MAGNETIC system**

34 komponentů

6 zásadních inovací

1 dokonale celý



## Dveřní kliky Nerez + magnetické rozety

Materiál rozet: **magnetická nerez ocel**

Materiál klik: **nerezová ocel**

Povrchy: **NRz** nerez broušeno, **TiN-K** titan černý mat, **K-industrial** černý mat strukturovaný

Konstrukce, mechanika: **magnetické rozety s 1 vratnou pružinou, mechanika 2018**

Konstrukční varianty: **Objekt, Projekt tř. 4**

Nejdokonalější a nejrychlejší systém montáže. Účinný systém, který dlouhodobě pevně fixuje kliky a MG rozety k dveřnímu křídle bez možnosti jakéhokoliv pohybu rozet po dveřním křídle, bez možnosti poškrábání dveří. Tloušťka pouhých 5 mm předurčuje MG rozety ke kombinaci s projektovými, tak s designovými řadami dveřních klik.

**NOVA TiN-K** titan černý mat



**PROMO NRz** nerez ocel broušeno

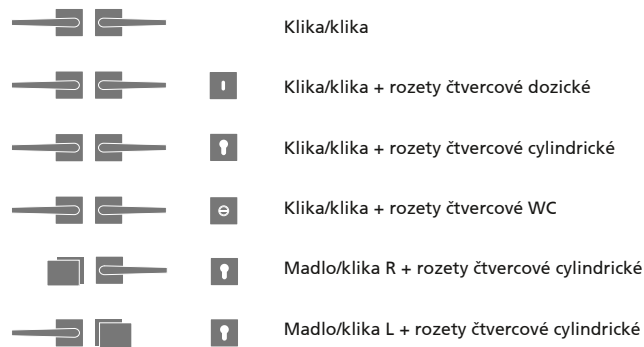

magnetické rozety Ø 54 mm, tl. 5 mm



magnetické rozety 54x54 mm, tl. 5 mm



konstrukční varianty, materiálové provedení

- set kování s 1 vratnou pružinou
- sešroubování pouzdry proti sobě
- příprava do dveří: vrtání otvoru průměr 24 – 25 mm
- provedení Projekt dodáváme automaticky ve variantě s protipožární úpravou, s nerezovým čtyřhranem
- zajišťovací gel proti uvolňování červíků
- vrtání PROFÍ šablonou M&T vrtákem Ø 6,4 mm
- montáž pro tloušťky dveří 38 – 126 mm
- v balení standardně montážní materiál pro tl. dveří 38 - 45 mm
- záruka 5 let povrch NRz, titan 15 let
- záruka mechanika 5 let provedení Objekt, 7 let provedení Projekt tř. 4

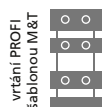

5 garance let 7 garance let

Ochranná známka – registrovaná značka

**ENTERO®**

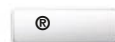

Chráněné průmyslové vzory klik



**MORGAN  
ENTERO  
SENZA  
PROMO  
NOVA  
KVADRA**



NRz nerez - broušeno

**Lusy**

930,- Kč  
39,- EUR

Kč	materiál: nerezová ocel povrch: NRz nerez - broušeno		EUR
930,-			39,-
1480,-			62,-
1480,-			62,-
1970,-			83,-
2210,-			93,-
2210,-			93,-



TiN-K titan černý mat



**Deny**

1080,- Kč  
45,- EUR

Kč	materiál: nerezová ocel povrch: NRz nerez - broušeno		EUR
1080,-			45,-
1630,-			68,-
1630,-			68,-
2110,-			88,-
2410,-			101,-
2410,-			101,-



Kliky v kategorii Projekt se vyrábějí jako protipožární a dodávají se včetně protipožárního nerezového čtyřhranu. Pro případ požadavku panikové funkce je třeba objednat variantu z kategorie dveřní kliky NEREZ str. 28 – 39. Dále je třeba objednat dělený čtyřhran a specifikovat přesnou délku čtyřhranu str. 369. Magnetické rozety se s panikovou funkcí nedodávají.

		Magnetická rozeta									
		Objekt						Projekt tř. 4 (i protipožární)			
		NRz		TiN-K		K-industrial		NRz		TiN-K	
		cena / pár	EAN	cena / pár	EAN	cena / pár	EAN	cena / pár	EAN	cena / pár	EAN
klika / klika	Kč €	930,- 39,-	089653	1760,- 74,-	089714	1760,- 74,-	138573	1340,- 56,-	115420	2330,- 98,-	115482
dozické	Kč €	1480,- 62,-	089660	2740,- 115,-	089721	2740,- 115,-	138580	1880,- 79,-	115437	3300,- 138,-	115499
cyindrické	Kč €	1480,- 62,-	089677	2740,- 115,-	089738	2740,- 115,-	138597	1880,- 79,-	115444	3300,- 138,-	115505
WC	Kč €	1970,- 83,-	089684	3240,- 135,-	089745	3240,- 135,-	138603	2400,- 100,-	115451	3810,- 159,-	115512
koule / klika R	Kč €	2210,- 93,-	089691	3480,- 145,-	089752	3480,- 145,-	138610	2630,- 110,-	115468	4040,- 169,-	115529
koule / klika L	Kč €	2210,- 93,-	089707	3480,- 145,-	089769	3480,- 145,-	138627	2630,- 110,-	115475	4040,- 169,-	115536

vrtání otvorů pro MG rozety

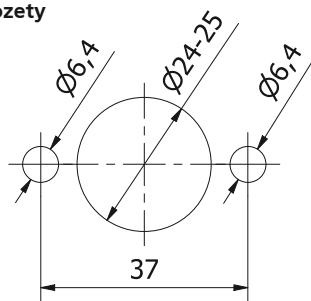

		Magnetická rozeta									
		Objekt						Projekt tř. 4 (i protipožární)			
		NRz		TiN-K		K-industrial		NRz		TiN-K	
		cena / pár	EAN	cena / pár	EAN	cena / pár	EAN	cena / pár	EAN	cena / pár	EAN
klika / klika	Kč €	1080,- 45,-	089776	1930,- 81,-	089837	1930,- 81,-	138634	1510,- 63,-	115543	2500,- 105,-	115604
dozické	Kč €	1630,- 68,-	089783	2910,- 122,-	089844	2910,- 122,-	138641	2050,- 86,-	115550	3460,- 145,-	115611
cyindrické	Kč €	1630,- 68,-	089790	2910,- 122,-	089851	2910,- 122,-	138658	2050,- 86,-	115567	3460,- 145,-	115628
WC	Kč €	2110,- 88,-	089806	3400,- 142,-	089868	3400,- 142,-	138665	2540,- 106,-	115574	3950,- 165,-	115635
koule / klika R	Kč €	2410,- 101,-	089813	3660,- 153,-	089875	3660,- 153,-	138672	2820,- 118,-	115581	4230,- 177,-	115642
koule / klika L	Kč €	2410,- 101,-	089820	3660,- 153,-	089882	3660,- 153,-	138689	2820,- 118,-	115598	4230,- 177,-	115659



NRz nerez - broušeno

**Meclis**

1250,- Kč  
53,- EUR

Kč	materiál: nerezová ocel povrch: NRz nerez - broušeno		EUR
1250,-			53,-
1780,-			75,-
1780,-			75,-
2270,-			95,-
2550,-			107,-
2550,-			107,-



TiN-K titan černý mat



**Morgan**

1250,- Kč  
53,- EUR

Kč	materiál: nerezová ocel povrch: NRz nerez - broušeno		EUR
1250,-			53,-
1780,-			75,-
1780,-			75,-
2270,-			95,-
2550,-			107,-
2550,-			107,-



Kliky v kategorii Projekt se vyrábějí jako protipožární a dodávají se včetně protipožárního nerezového čtyřhranu. Pro případ požadavku panikové funkce je třeba objednat variantu z kategorie dveřní kličky NEREZ str. 28 – 39. Dále je třeba objednat dělený čtyřhran a specifikovat přesnou délku čtyřhranu str. 369. Magnetické rozety se s panikovou funkcí nedodávají.

	Magnetická rozeta										
	Objekt							Projekt tř. 4 (i protipožární)			
	NRz		TiN-K		K-industrial		NRz		TiN-K		
	cena / pár	EAN	cena / pár	EAN	cena / pár	EAN	cena / pár	EAN	cena / pár	EAN	
klika / klika	Kč €	1250,- 53,-	089899	2070,- 87,-	089950	2070,- 87,-	138696	1650,- 69,-	115666	2640,- 110,-	115727
dozické	Kč €	1780,- 75,-	089905	3050,- 128,-	089967	3050,- 128,-	138702	2210,- 93,-	115673	3620,- 151,-	115734
cyindrické	Kč €	1780,- 75,-	089912	3050,- 128,-	089974	3050,- 128,-	138719	2210,- 93,-	115680	3620,- 151,-	115741
WC	Kč €	2270,- 95,-	089929	3530,- 148,-	089981	3530,- 148,-	138726	2710,- 113,-	115697	4110,- 172,-	115758
koule / klika R	Kč €	2550,- 107,-	089936	3830,- 160,-	089998	3830,- 160,-	138733	2970,- 124,-	115703	4390,- 183,-	115765
koule / klika L	Kč €	2550,- 107,-	089943	3830,- 160,-	090000	3830,- 160,-	138740	2970,- 124,-	115710	4390,- 183,-	115772

	Magnetická rozeta										
	Objekt							Projekt tř. 4 (i protipožární)			
	NRz		TiN-K		K-industrial		NRz		TiN-K		
	cena / pár	EAN	cena / pár	EAN	cena / pár	EAN	cena / pár	EAN	cena / pár	EAN	
klika / klika	Kč €	1250,- 53,-	090017	2070,- 87,-	090079	2070,- 87,-	138757	1650,- 69,-	115789	2640,- 110,-	115840
dozické	Kč €	1780,- 75,-	090024	3050,- 128,-	090086	3050,- 128,-	138764	2210,- 93,-	115796	3620,- 151,-	115857
cyindrické	Kč €	1780,- 75,-	090031	3050,- 128,-	090093	3050,- 128,-	138771	2210,- 93,-	115802	3620,- 151,-	115864
WC	Kč €	2270,- 95,-	090048	3530,- 148,-	090109	3530,- 148,-	138788	2710,- 113,-	115819	4110,- 172,-	115871
koule / klika R	Kč €	2550,- 107,-	090055	3830,- 160,-	090116	3830,- 160,-	138795	2970,- 124,-	115826	4390,- 183,-	115888
koule / klika L	Kč €	2550,- 107,-	090062	3830,- 160,-	090123	3830,- 160,-	138801	2970,- 124,-	115833	4390,- 183,-	115895



NRz nerez - broušeno

**Jameson**

1380,- Kč  
58,- EUR

Kč	materiál: nerezová ocel povrch: NRz nerez - broušeno	EUR
1380,-		58,-
1940,-		81,-
1940,-		81,-
2430,-		102,-
2720,-		114,-
2720,-		114,-



TIN-K titan černý mat



**Nova**

1710,- Kč  
72,- EUR

Kč	materiál: nerezová ocel povrch: NRz nerez - broušeno	EUR
1710,-		72,-
2250,-		94,-
2250,-		94,-
2740,-		115,-
3030,-		127,-
3030,-		127,-



Kliky v kategorii Projekt se vyrábějí jako protipožární a dodávají se včetně protipožárního nerezového čtyřhranu. Pro případ požadavku panikové funkce je třeba objednat variantu z kategorie dveřní kličky NEREZ str. 28 – 39. Dále je třeba objednat dělený čtyřhran a specifikovat přesnou délku čtyřhranu str. 369. Magnetické rozety se s panikovou funkcí nedodávají.

	Magnetická rozeta										
	Objekt							Projekt tř. 4 (i protipožární)			
	NRz		TiN-K		K-industrial		NRz		TiN-K		
	cena / pár	EAN	cena / pár	EAN	cena / pár	EAN	cena / pár	EAN	cena / pár	EAN	
klika / klika	Kč €	1380,- 58,-	090130	2240,- 94,-	090192	2240,- 94,-	138818	1820,- 76,-	115901	2800,- 117,-	115963
dozické	Kč €	1940,- 81,-	090147	3210,- 134,-	090208	3210,- 134,-	138825	2360,- 99,-	115918	3760,- 157,-	115970
cyindrické	Kč €	1940,- 81,-	090154	3210,- 134,-	090215	3210,- 134,-	138832	2360,- 99,-	115925	3760,- 157,-	115987
WC	Kč €	2430,- 102,-	090161	3700,- 155,-	090222	3700,- 155,-	138849	2860,- 120,-	115932	4280,- 179,-	115994
koule / klika R	Kč €	2720,- 114,-	090178	3980,- 166,-	090239	3980,- 166,-	138856	3140,- 131,-	115949	4540,- 190,-	116007
koule / klika L	Kč €	2720,- 114,-	090185	3980,- 166,-	090246	3980,- 166,-	138863	3140,- 131,-	115956	4540,- 190,-	116014

	Magnetická rozeta										
	Objekt							Projekt tř. 4 (i protipožární)			
	NRz		TiN-K		K-industrial		NRz		TiN-K		
	cena / pár	EAN	cena / pár	EAN	cena / pár	EAN	cena / pár	EAN	cena / pár	EAN	
klika / klika	Kč €	1710,- 72,-	090253	2540,- 106,-	090314	2540,- 106,-	138870	2110,- 88,-	116021	3110,- 130,-	116083
dozické	Kč €	2250,- 94,-	090260	3510,- 147,-	090321	3510,- 147,-	138887	2670,- 112,-	116038	4090,- 171,-	116090
cyindrické	Kč €	2250,- 94,-	090277	3510,- 147,-	090338	3510,- 147,-	138894	2670,- 112,-	116045	4090,- 171,-	116106
WC	Kč €	2740,- 115,-	090284	4000,- 167,-	090345	4000,- 167,-	138900	3160,- 132,-	116052	4580,- 191,-	116113
koule / klika R	Kč €	3030,- 127,-	090291	4300,- 180,-	090352	4300,- 180,-	138917	3440,- 144,-	116069	4850,- 203,-	116120
koule / klika L	Kč €	3030,- 127,-	090307	4300,- 180,-	090369	4300,- 180,-	138924	3440,- 144,-	116076	4850,- 203,-	116137



NRz nerez - broušeno

**Promo**

1850,- Kč  
78,- EUR

Kč	materiál: nerezová ocel povrch: NRz nerez - broušeno		EUR
1850,-			78,-
2410,-			101,-
2410,-			101,-
2910,-			122,-
3180,-			133,-
3180,-			133,-



**Senza**

1710,- Kč  
72,- EUR

Kč	materiál: nerezová ocel povrch: NRz nerez - broušeno		EUR
1710,-			72,-
2250,-			94,-
2250,-			94,-
2740,-			115,-
3030,-			127,-
3030,-			127,-



Kliky v kategorii Projekt se vyrábějí jako protipožární a dodávají se včetně protipožárního nerezového čtyřhranu. Pro případ požadavku panikové funkce je třeba objednat variantu z kategorie dveřní kličky NEREZ str. 28 – 39. Dále je třeba objednat dělený čtyřhran a specifikovat přesnou délku čtyřhranu str. 369. Magnetické rozety se s panikovou funkcí nedodávají.



	Magnetická rozeta										
	Objekt						Projekt tř. 4 (i protipožární)				
	NRz		TiN-K		K-industrial		NRz		TiN-K		
	cena / pár	EAN	cena / pár	EAN	cena / pár	EAN	cena / pár	EAN	cena / pár	EAN	
klika / klika	Kč €	1850,- 78,-	090499	2710,- 113,-	170443	2710,- 113,-	138931	2270,- 95,-	116205	3260,- 136,-	170566
dozické	Kč €	2410,- 101,-	090505	3660,- 153,-	170450	3660,- 153,-	138948	2820,- 118,-	116212	4230,- 177,-	170573
cyindrické	Kč €	2410,- 101,-	090512	3660,- 153,-	170467	3660,- 153,-	138955	2820,- 118,-	116229	4230,- 177,-	170580
WC	Kč €	2910,- 122,-	090529	4160,- 174,-	170474	4160,- 174,-	138962	3320,- 139,-	116236	4730,- 198,-	170595
koule / klika R	Kč €	3180,- 133,-	090536	4440,- 185,-	170481	4440,- 185,-	138979	3610,- 151,-	116243	5020,- 210,-	170603
koule / klika L	Kč €	3180,- 133,-	090543	4440,- 185,-	170498	4440,- 185,-	138986	3610,- 151,-	116250	5020,- 210,-	170610

	Magnetická rozeta										
	Objekt						Projekt tř. 4 (i protipožární)				
	NRz		TiN-K		K-industrial		NRz		TiN-K		
	cena / pár	EAN	cena / pár	EAN	cena / pár	EAN	cena / pár	EAN	cena / pár	EAN	
klika / klika	Kč €	1710,- 72,-	090376	2550,- 107,-	170504	2550,- 107,-	138993	2110,- 88,-	116144	3260,- 136,-	170627
dozické	Kč €	2250,- 94,-	090383	3510,- 147,-	170511	3510,- 147,-	139006	2670,- 112,-	116151	4230,- 177,-	170634
cyindrické	Kč €	2250,- 94,-	090390	3510,- 147,-	170528	3510,- 147,-	139013	2670,- 112,-	116168	4230,- 177,-	170641
WC	Kč €	2740,- 115,-	090406	4000,- 167,-	170535	4000,- 167,-	139020	3160,- 132,-	116175	4730,- 198,-	170658
koule / klika R	Kč €	3030,- 127,-	090413	4290,- 179,-	170542	4290,- 179,-	139037	3440,- 144,-	116182	5020,- 210,-	170665
koule / klika L	Kč €	3030,- 127,-	090420	4290,- 179,-	170559	4290,- 179,-	139044	3440,- 144,-	116199	5020,- 210,-	170672



NRz nerez - broušeno

**Kvadra**

1850,- Kč  
78,- EUR

Kč	materiál: nerezová ocel povrch: NRz nerez - broušeno		EUR
1850,-			78,-
2410,-			101,-
2410,-			101,-
2910,-			122,-
3180,-			133,-
3180,-			133,-



TiN-K titan černý mat



**Entero**

1850,- Kč  
78,- EUR

Kč	materiál: nerezová ocel povrch: NRz nerez - broušeno		EUR
1850,-			78,-
2410,-			101,-
2410,-			101,-
2910,-			122,-
3180,-			133,-
3180,-			133,-



Kliky v kategorii Projekt se vyrábějí jako protipožární a dodávají se včetně protipožárního nerezového čtyřhranu. Pro případ požadavku panikové funkce je třeba objednat variantu z kategorie dveřní kličky NEREZ str. 28 – 39. Dále je třeba objednat dělený čtyřhran a specifikovat přesnou délku čtyřhranu str. 369. Magnetické rozety se s panikovou funkcí nedodávají.

		Magnetická rozeta									
		Objekt						Projekt tř. 4 (i protipožární)			
		NRz		TiN-K		K-industrial		NRz		TiN-K	
		cena / pár	EAN	cena / pár	EAN	cena / pár	EAN	cena / pár	EAN	cena / pár	EAN
klika / klika	Kč €	1850,- 78,-	090734	2710,- 113,-	090796	2710,- 113,-	139051	2270,- 95,-	116380	3260,- 136,-	116441
dozické	Kč €	2410,- 101,-	090741	3660,- 153,-	090802	3660,- 153,-	139068	2820,- 118,-	116397	4230,- 177,-	116458
cyklindrické	Kč €	2410,- 101,-	090758	3660,- 153,-	090819	3660,- 153,-	139075	2820,- 118,-	116403	4230,- 177,-	116465
WC	Kč €	2910,- 122,-	090765	4160,- 174,-	090826	4160,- 174,-	139082	3320,- 139,-	116410	4730,- 198,-	116472
koule / klika R	Kč €	3180,- 133,-	090772	4440,- 185,-	090833	4440,- 185,-	139099	3610,- 151,-	116427	5020,- 210,-	116489
koule / klika L	Kč €	3180,- 133,-	090789	4440,- 185,-	090840	4440,- 185,-	139105	3610,- 151,-	116434	5020,- 210,-	116496

		Magnetická rozeta									
		Objekt						Projekt tř. 4 (i protipožární)			
		NRz		TiN-K		K-industrial		NRz		TiN-K	
		cena / pár	EAN	cena / pár	EAN	cena / pár	EAN	cena / pár	EAN	cena / pár	EAN
klika / klika	Kč €	1850,- 78,-	090611	2710,- 113,-	090673	2710,- 113,-	139112	2270,- 95,-	116267	3260,- 136,-	116328
dozické	Kč €	2410,- 101,-	090628	3660,- 153,-	090680	3660,- 153,-	139129	2820,- 118,-	116274	4230,- 177,-	116335
cyklindrické	Kč €	2410,- 101,-	090635	3660,- 153,-	090697	3660,- 153,-	139136	2820,- 118,-	116281	4230,- 177,-	116342
WC	Kč €	2910,- 122,-	090642	4160,- 174,-	090703	4160,- 174,-	139143	3320,- 139,-	116298	4730,- 198,-	116359
koule / klika R	Kč €	3180,- 133,-	090659	4440,- 185,-	090710	4440,- 185,-	139150	3610,- 151,-	116304	5020,- 210,-	116366
koule / klika L	Kč €	3180,- 133,-	090666	4440,- 185,-	090727	4440,- 185,-	139167	3610,- 151,-	116311	5020,- 210,-	116373



NRz nerez - broušeno

**Techno**

1710,- Kč  
72,- EUR



**Cesan**

1540,- Kč  
65,- EUR



TiN-K titan černý mat

materiál: nerezová ocel  
povrch: NRz nerez - broušeno

Kč		EUR
1710,-		72,-
2250,-		94,-
2250,-		94,-
2740,-		115,-
3030,-		127,-
3030,-		127,-

materiál: nerezová ocel  
povrch: NRz nerez - broušeno

Kč		EUR
1540,-		65,-
2080,-		87,-
2080,-		87,-
2590,-		108,-
2870,-		120,-
2870,-		120,-

Kliky v kategorii Projekt se vyrábějí jako protipožární a dodávají se včetně protipožárního nerezového čtyřhranu. Pro případ požadavku panikové funkce je třeba objednat variantu z kategorie dveřní kličky NEREZ str. 28 – 39. Dále je třeba objednat dělený čtyřhran a specifikovat přesnou délku čtyřhranu str. 369. Magnetické rozety se s panikovou funkcí nedodávají.

	Magnetická rozeta										
	Objekt						Projekt tř. 4 (i protipožární)				
	NRz		TiN-K		K-industrial		NRz		TiN-K		
	cena / pár	EAN	cena / pár	EAN	cena / pár	EAN	cena / pár	EAN	cena / pár	EAN	
klika / klika	Kč €	1710,- 72,-	090857			2550,- 107,-	139174	2110,- 88,-	116502		
dozické	Kč €	2250,- 94,-	090864			3510,- 147,-	139181	2670,- 112,-	116519		
cyindrické	Kč €	2250,- 94,-	090871			3510,- 147,-	139198	2670,- 112,-	116526		
WC	Kč €	2740,- 115,-	090888			4000,- 167,-	139204	3160,- 132,-	116533		
koule / klika R	Kč €	3030,- 127,-	090895			4290,- 179,-	139211	3440,- 144,-	116540		
koule / klika L	Kč €	3030,- 127,-	090901			4290,- 179,-	139228	3440,- 144,-	116557		

	Magnetická rozeta										
	Objekt						Projekt tř. 4 (i protipožární)				
	NRz		TiN-K		K-industrial		NRz		TiN-K		
	cena / pár	EAN	cena / pár	EAN	cena / pár	EAN	cena / pár	EAN	cena / pár	EAN	
klika / klika	Kč €	1540,- 65,-	090970	2400,- 100,-	091038	2400,- 100,-	139235	1970,- 83,-	116564	2950,- 123,-	116625
dozické	Kč €	2080,- 87,-	090987	3370,- 141,-	091045	3370,- 141,-	139242	2520,- 105,-	116571	3930,- 164,-	116632
cyindrické	Kč €	2080,- 87,-	090994	3370,- 141,-	091052	3370,- 141,-	139259	2520,- 105,-	116588	3930,- 164,-	116649
WC	Kč €	2590,- 108,-	091007	3850,- 161,-	091069	3850,- 161,-	139266	3000,- 125,-	116595	4410,- 184,-	116656
koule / klika R	Kč €	2870,- 120,-	091014	4140,- 173,-	091076	4140,- 173,-	139273	3290,- 138,-	116601	4700,- 196,-	116663
koule / klika L	Kč €	2870,- 120,-	091021	4140,- 173,-	091083	4140,- 173,-	139280	3290,- 138,-	116618	4700,- 196,-	116670



NRz nerez - broušeno

**Hanna**

1710,- Kč  
72,- EUR

Kč	materiál: nerezová ocel povrch: NRz nerez - broušeno		EUR
1710,-			72,-
2250,-			94,-
2250,-			94,-
2740,-			115,-
3030,-			127,-
3030,-			127,-

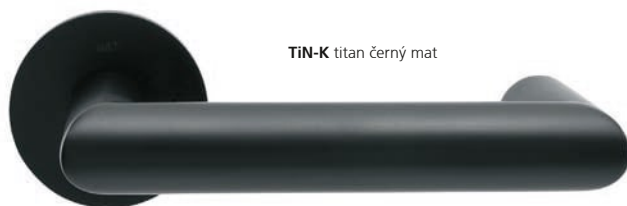

TiN-K titan černý mat



**Sonia**

1540,- Kč  
65,- EUR

Kč	materiál: nerezová ocel povrch: NRz nerez - broušeno		EUR
1540,-			65,-
2080,-			87,-
2080,-			87,-
2590,-			108,-
2870,-			120,-
2870,-			120,-



Kliky v kategorii Projekt se vyrábějí jako protipožární a dodávají se včetně protipožárního nerezového čtyřhranu. Pro případ požadavku panikové funkce je třeba objednat variantu z kategorie dveřní kličky NEREZ str. 28 – 39. Dále je třeba objednat dělený čtyřhran a specifikovat přesnou délku čtyřhranu str. 369. Magnetické rozety se s panikovou funkcí nedodávají.

	Magnetická rozeta										
	Objekt						Projekt tř. 4 (i protipožární)				
	NRz		TiN-K		K-industrial		NRz		TiN-K		
	cena / pár	EAN	cena / pár	EAN	cena / pár	EAN	cena / pár	EAN	cena / pár	EAN	
klika / klika	Kč €	1710,- 72,-	114966	2710,- 113,-	115024	2710,- 113,-	139297	2110,- 88,-	116687	3260,- 136,-	116748
dozické	Kč €	2250,- 94,-	114973	3660,- 153,-	115031	3660,- 153,-	139303	2670,- 112,-	116694	4230,- 177,-	116755
cyklindrické	Kč €	2250,- 94,-	114980	3660,- 153,-	115048	3660,- 153,-	139310	2670,- 112,-	116700	4230,- 177,-	116762
WC	Kč €	2740,- 115,-	114997	4160,- 174,-	115055	4160,- 174,-	139327	3160,- 132,-	116717	4730,- 198,-	116779
koule / klika R	Kč €	3030,- 127,-	115000	4440,- 185,-	115062	4440,- 185,-	139334	3440,- 144,-	116724	5020,- 210,-	116786
koule / klika L	Kč €	3030,- 127,-	115017	4440,- 185,-	115079	4440,- 185,-	139341	3440,- 144,-	116731	5020,- 210,-	116793

	Magnetická rozeta										
	Objekt						Projekt tř. 4 (i protipožární)				
	NRz		TiN-K		K-industrial		NRz		TiN-K		
	cena / pár	EAN	cena / pár	EAN	cena / pár	EAN	cena / pár	EAN	cena / pár	EAN	
klika / klika	Kč €	1540,- 65,-	115086	2400,- 100,-	115147	2400,- 100,-	139358	1970,- 83,-	116809	2950,- 123,-	116861
dozické	Kč €	2080,- 87,-	115093	3370,- 141,-	115154	3370,- 141,-	139365	2520,- 105,-	116816	3930,- 164,-	116878
cyklindrické	Kč €	2080,- 87,-	115109	3370,- 141,-	115161	3370,- 141,-	139372	2520,- 105,-	116823	3930,- 164,-	116885
WC	Kč €	2590,- 108,-	115116	3850,- 161,-	115178	3850,- 161,-	139389	3000,- 125,-	116830	4410,- 184,-	116892
koule / klika R	Kč €	2870,- 120,-	115123	4140,- 173,-	115185	4140,- 173,-	139396	3290,- 138,-	116847	4700,- 196,-	116908
koule / klika L	Kč €	2870,- 120,-	115130	4140,- 173,-	115192	4140,- 173,-	139402	3290,- 138,-	116854	4700,- 196,-	116915



NRz nerez - broušeno

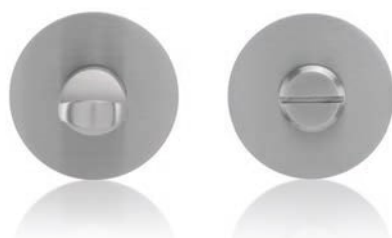

**Spodní rozety**

580,- Kč  
25,- EUR

Kč	materiál: nerezová ocel povrch: NRz nerez - broušeno	EUR
580,-		25,-
580,-		25,-
1060,-		45,-
720,-		30,-



TiN-K titan černý mat



NRz nerez - broušeno



**Spodní rozety**

690,- Kč  
29,- EUR

Kč	materiál: nerezová ocel povrch: NRz nerez - broušeno	EUR
690,-		29,-
690,-		29,-
1270,-		53,-
840,-		35,-



TiN-K titan černý mat



		<b>Magnetická rozeta</b>					
		<b>Objekt</b>					
		<b>NRz</b>		<b>TiN-K</b>		<b>K-industrial</b>	
		cena / pár	EAN	cena / pár	EAN	cena / pár	EAN
dozické	Kč €	580,- 25,-	091571	1340,- 56,-	091601	1340,- 56,-	140255
cylindrické	Kč €	580,- 25,-	091588	1340,- 56,-	091618	1340,- 56,-	140262
WC	Kč €	1060,- 45,-	091595	1980,- 83,-	091625	1980,- 83,-	140279
plná/zaslepovací	Kč €	720,- 30,-	104851	1490,- 63,-	104875	1490,- 63,-	140286

		<b>Magnetická rozeta</b>					
		<b>Objekt</b>					
		<b>NRz</b>		<b>TiN-K</b>		<b>K-industrial</b>	
		cena / pár	EAN	cena / pár	EAN	cena / pár	EAN
dozické	Kč €	690,- 29,-	093551	1480,- 62,-	093582	1480,- 62,-	140293
cylindrické	Kč €	690,- 29,-	093568	1480,- 62,-	093599	1480,- 62,-	140309
WC	Kč €	1270,- 53,-	093575	2180,- 91,-	093605	2180,- 91,-	140316
plná/zaslepovací	Kč €	840,- 35,-	105032	1620,- 68,-	105056	1620,- 68,-	140323



NRz nerez - broušeno

**Lusy**

1050,- Kč  
44,- EUR

Kč	materiál: nerezová ocel povrch: NRz nerez - broušeno	EUR
1050,-		44,-
1730,-		73,-
1730,-		73,-
2290,-		96,-
2640,-		110,-
2640,-		110,-

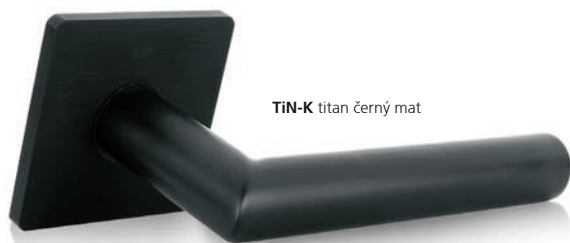

TiN-K titan černý mat



**Deny**

1250,- Kč  
53,- EUR

Kč	materiál: nerezová ocel povrch: NRz nerez - broušeno	EUR
1250,-		53,-
1920,-		80,-
1920,-		80,-
2470,-		103,-
2840,-		119,-
2840,-		119,-



Kliky v kategorii Projekt se vyrábějí jako protipožární a dodávají se včetně protipožárního nerezového čtyřhranu. Pro případ požadavku panikové funkce je třeba objednat variantu z kategorie dveřní kličky NEREZ str. 28 – 39. Dále je třeba objednat dělený čtyřhran a specifikovat přesnou délku čtyřhranu str. 369. Magnetické rozety se s panikovou funkcí nedodávají.

	Magnetická rozeta										
	Objekt							Projekt tř. 4 (i protipožární)			
	NRz		TiN-K		K-industrial		NRz		TiN-K		
	cena / pár	EAN	cena / pár	EAN	cena / pár	EAN	cena / pár	EAN	cena / pár	EAN	
klika / klika	Kč €	1050,- 44,-	091632	1880,- 79,-	091694	1880,- 79,-	139419	1480,- 62,-	116922	2460,- 103,-	116984
dozické	Kč €	1730,- 73,-	091649	2990,- 125,-	091700	2990,- 125,-	139426	2160,- 90,-	116939	3570,- 149,-	116991
cyklindrické	Kč €	1730,- 73,-	091656	2990,- 125,-	091717	2990,- 125,-	139433	2160,- 90,-	116946	3570,- 149,-	117004
WC	Kč €	2290,- 96,-	091663	3570,- 149,-	091724	3570,- 149,-	139440	2720,- 114,-	116953	4130,- 173,-	117011
madlo / klika R	Kč €	2640,- 110,-	091670	3920,- 164,-	091731	3920,- 164,-	139457	3060,- 128,-	116960	4480,- 187,-	117028
madlo / klika L	Kč €	2640,- 110,-	091687	3920,- 164,-	091748	3920,- 164,-	139464	3060,- 128,-	116977	4480,- 187,-	117035

	Magnetická rozeta										
	Objekt							Projekt tř. 4 (i protipožární)			
	NRz		TiN-K		K-industrial		NRz		TiN-K		
	cena / pár	EAN	cena / pár	EAN	cena / pár	EAN	cena / pár	EAN	cena / pár	EAN	
klika / klika	Kč €	1250,- 53,-	091755	2070,- 87,-	091816	2070,- 87,-	139471	1650,- 69,-	117042	2640,- 110,-	117103
dozické	Kč €	1920,- 80,-	091762	3180,- 133,-	091823	3180,- 133,-	139488	2330,- 98,-	117059	3740,- 156,-	117110
cyklindrické	Kč €	1920,- 80,-	091779	3180,- 133,-	091830	3180,- 133,-	138495	2330,- 98,-	117066	3740,- 156,-	117127
WC	Kč €	2470,- 103,-	091786	3740,- 156,-	091847	3740,- 156,-	139501	2910,- 122,-	117073	4310,- 180,-	117134
madlo / klika R	Kč €	2840,- 119,-	091793	4110,- 172,-	091854	4110,- 172,-	139518	3260,- 136,-	117080	4670,- 195,-	117141
madlo / klika L	Kč €	2840,- 119,-	091809	4110,- 172,-	091861	4110,- 172,-	139525	3260,- 136,-	117097	4670,- 195,-	117158



NRz nerez - broušeno

**Meclis**

1540,- Kč  
65,- EUR

Kč	materiál: nerezová ocel povrch: NRz nerez - broušeno	EUR
1540,-		65,-
2220,-		93,-
2220,-		93,-
2770,-		116,-
3150,-		132,-
3150,-		132,-



TiN-K titan černý mat



**Morgan**

1540,- Kč  
65,- EUR

Kč	materiál: nerezová ocel povrch: NRz nerez - broušeno	EUR
1540,-		65,-
2220,-		93,-
2220,-		93,-
2770,-		116,-
3150,-		132,-
3150,-		132,-



Kliky v kategorii Projekt se vyrábějí jako protipožární a dodávají se včetně protipožárního nerezového čtyřhranu. Pro případ požadavku panikové funkce je třeba objednat variantu z kategorie dveřní kličky NEREZ str. 28 – 39. Dále je třeba objednat dělený čtyřhran a specifikovat přesnou délku čtyřhranu str. 369. Magnetické rozety se s panikovou funkcí nedodávají.

	Magnetická rozeta										
	Objekt						Projekt tř. 4 (i protipožární)				
	NRz		TiN-K		K-industrial		NRz		TiN-K		
	cena / pár	EAN	cena / pár	EAN	cena / pár	EAN	cena / pár	EAN	cena / pár	EAN	
klika / klika	Kč €	1540,- 65,-	091878	2400,- 100,-	091939	2400,- 100,-	139532	1970,- 83,-	117165	2950,- 123,-	117233
dozické	Kč €	2220,- 93,-	091885	3490,- 146,-	091946	3490,- 146,-	139549	2640,- 110,-	117172	4050,- 169,-	117240
cyklindrické	Kč €	2220,- 93,-	091892	3490,- 146,-	091953	3490,- 146,-	139556	2640,- 110,-	117189	4050,- 169,-	117257
WC	Kč €	2770,- 116,-	091908	4050,- 169,-	091960	4050,- 169,-	139563	3210,- 134,-	117202	4620,- 193,-	117264
madlo / klika R	Kč €	3150,- 132,-	091915	4410,- 184,-	091977	4410,- 184,-	139570	3590,- 150,-	117219	4990,- 208,-	117271
madlo / klika L	Kč €	3150,- 132,-	091922	4410,- 184,-	091984	4410,- 184,-	139587	3590,- 150,-	117226	4990,- 208,-	117288

	Magnetická rozeta										
	Objekt						Projekt tř. 4 (i protipožární)				
	NRz		TiN-K		K-industrial		NRz		TiN-K		
	cena / pár	EAN	cena / pár	EAN	cena / pár	EAN	cena / pár	EAN	cena / pár	EAN	
klika / klika	Kč €	1540,- 65,-	091991	2400,- 100,-	092059	2400,- 100,-	139594	1970,- 83,-	117295	2950,- 123,-	117356
dozické	Kč €	2220,- 93,-	092004	3490,- 146,-	092066	3490,- 146,-	139600	2640,- 110,-	117301	4050,- 169,-	117363
cyklindrické	Kč €	2220,- 93,-	092011	3490,- 146,-	092073	3490,- 146,-	139617	2640,- 110,-	117318	4050,- 169,-	117370
WC	Kč €	2770,- 116,-	092028	4050,- 169,-	092080	4050,- 169,-	139624	3210,- 134,-	117325	4620,- 193,-	117387
madlo / klika R	Kč €	3150,- 132,-	092035	4410,- 184,-	092097	4410,- 184,-	139631	3590,- 150,-	117332	4990,- 208,-	117394
madlo / klika L	Kč €	3150,- 132,-	092042	4410,- 184,-	092103	4410,- 184,-	139648	3590,- 150,-	117349	4990,- 208,-	117400

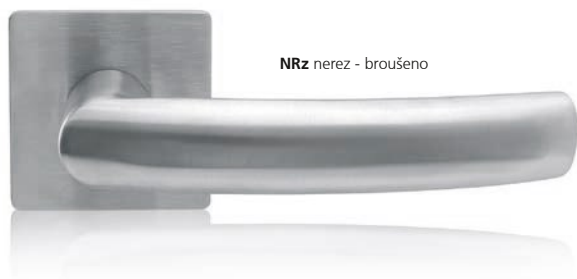

NRz nerez - broušeno

**Jameson**

1710,- Kč  
72,- EUR



TiN-K titan černý mat



**Nova**

2010,- Kč  
84,- EUR



materiál: nerezová ocel  
povrch: NRz nerez - broušeno

**KČ** **EUR**

1710,- 72,-

2380,- 100,-

2380,- 100,-

2940,- 123,-

3300,- 138,-

3300,- 138,-

materiál: nerezová ocel  
povrch: NRz nerez - broušeno

**KČ** **EUR**

2010,- 84,-

2700,- 113,-

2700,- 113,-

3250,- 136,-

3620,- 151,-

3620,- 151,-

Kliky v kategorii Projekt se vyrábějí jako protipožární a dodávají se včetně protipožárního nerezového čtyřhranu. Pro případ požadavku panikové funkce je třeba objednat variantu z kategorie dveřní kličky NEREZ str. 28 – 39. Dále je třeba objednat dělený čtyřhran a specifikovat přesnou délku čtyřhranu str. 369. Magnetické rozety se s panikovou funkcí nedodávají.

	Magnetická rozeta										
	Objekt						Projekt tř. 4 (i protipožární)				
	NRz		TiN-K		K-industrial		NRz		TiN-K		
	cena / pár	EAN	cena / pár	EAN	cena / pár	EAN	cena / pár	EAN	cena / pár	EAN	
klika / klika	Kč €	1710,- 72,-	092110	2540,- 106,-	092172	2540,- 106,-	139655	2110,- 88,-	117417	3110,- 130,-	117479
dozické	Kč €	2380,- 100,-	092127	3640,- 152,-	092189	3640,- 152,-	139662	2800,- 117,-	117424	4200,- 175,-	117486
cyklindrické	Kč €	2380,- 100,-	092134	3640,- 152,-	092196	3640,- 152,-	139679	2800,- 117,-	117431	4200,- 175,-	117493
WC	Kč €	2940,- 123,-	092141	4200,- 175,-	092202	4200,- 175,-	139686	3370,- 141,-	117448	4770,- 199,-	117509
madlo / klika R	Kč €	3300,- 138,-	092158	4580,- 191,-	092219	4580,- 191,-	139693	3600,- 150,-	117455	5140,- 215,-	117516
madlo / klika L	Kč €	3300,- 138,-	092165	4580,- 191,-	092226	4580,- 191,-	139709	3600,- 150,-	117462	5140,- 215,-	117523

	Magnetická rozeta										
	Objekt						Projekt tř. 4 (i protipožární)				
	NRz		TiN-K		K-industrial		NRz		TiN-K		
	cena / pár	EAN	cena / pár	EAN	cena / pár	EAN	cena / pár	EAN	cena / pár	EAN	
klika / klika	Kč €	2010,- 84,-	092233	2860,- 120,-	092295	2860,- 120,-	139716	2430,- 102,-	117530	3420,- 143,-	117592
dozické	Kč €	2700,- 113,-	092240	3950,- 165,-	092301	3950,- 165,-	139723	3110,- 130,-	117547	4520,- 189,-	117608
cyklindrické	Kč €	2700,- 113,-	092257	3950,- 165,-	092318	3950,- 165,-	139730	3110,- 130,-	117554	4520,- 189,-	117615
WC	Kč €	3250,- 136,-	092264	4520,- 189,-	092325	4520,- 189,-	139747	3660,- 153,-	117561	5080,- 212,-	117622
madlo / klika R	Kč €	3620,- 151,-	092271	4880,- 204,-	092332	4880,- 204,-	139754	4040,- 169,-	117578	5460,- 228,-	117639
madlo / klika L	Kč €	3620,- 151,-	092288	4880,- 204,-	092349	4880,- 204,-	139761	4040,- 169,-	117585	5460,- 228,-	117646



NRz nerez - broušeno



**Promo**

2010,- Kč  
84,- EUR

Kč	materiál: nerezová ocel povrch: NRz nerez - broušeno	EUR
2010,-		84,-
2700,-		113,-
2700,-		113,-
3250,-		136,-
3620,-		151,-
3620,-		151,-



**Senza**

1850,- Kč  
78,- EUR

Kč	materiál: nerezová ocel povrch: NRz nerez - broušeno	EUR
1850,-		78,-
2420,-		101,-
2420,-		101,-
3100,-		130,-
3460,-		145,-
3460,-		145,-

Kliky v kategorii Projekt se vyrábějí jako protipožární a dodávají se včetně protipožárního nerezového čtyřhranu. Pro případ požadavku panikové funkce je třeba objednat variantu z kategorie dveřní kličky NEREZ str. 28 – 39. Dále je třeba objednat dělený čtyřhran a specifikovat přesnou délku čtyřhranu str. 369. Magnetické rozety se s panikovou funkcí nedodávají.



	Magnetická rozeta										
	Objekt						Projekt tř. 4 (i protipožární)				
	NRz		TiN-K		K-industrial		NRz		TiN-K		
	cena / pár	EAN	cena / pár	EAN	cena / pár	EAN	cena / pár	EAN	cena / pár	EAN	
klika / klika	Kč €	2010,- 84,-	092479	2860,- 120,-	170689	2860,- 120,-	139778	2430,- 102,-	117714	3420,- 143,-	170801
dozické	Kč €	2700,- 113,-	092486	3950,- 165,-	170696	3950,- 165,-	139785	3110,- 130,-	117721	4520,- 189,-	170818
cyindrické	Kč €	2700,- 113,-	092493	3950,- 165,-	170702	3950,- 165,-	139792	3110,- 130,-	117738	4520,- 189,-	170825
WC	Kč €	3250,- 136,-	092509	4510,- 188,-	170719	4510,- 188,-	139808	3660,- 153,-	117745	5080,- 212,-	170832
madlo / klika R	Kč €	3620,- 151,-	092516	4880,- 204,-	170726	4880,- 204,-	139815	4040,- 169,-	117752	5590,- 233,-	170849
madlo / klika L	Kč €	3620,- 151,-	092523	4880,- 204,-	170733	4880,- 204,-	139822	4040,- 169,-	117769	5590,- 233,-	170856

	Magnetická rozeta										
	Objekt						Projekt tř. 4 (i protipožární)				
	NRz		TiN-K		K-industrial		NRz		TiN-K		
	cena / pár	EAN	cena / pár	EAN	cena / pár	EAN	cena / pár	EAN	cena / pár	EAN	
klika / klika	Kč €	1850,- 78,-	092356	2710,- 113,-	170740	2710,- 113,-	139839	2270,- 95,-	117653	3260,- 136,-	170863
dozické	Kč €	2420,- 101,-	092363	3690,- 154,-	170757	3690,- 154,-	139846	2950,- 123,-	117660	4370,- 183,-	170870
cyindrické	Kč €	2420,- 101,-	092370	3690,- 154,-	170764	3690,- 154,-	139853	2950,- 123,-	117677	4370,- 183,-	170887
WC	Kč €	3100,- 130,-	092387	4370,- 183,-	170771	4370,- 183,-	139860	3510,- 147,-	117684	4920,- 205,-	170894
madlo / klika R	Kč €	3460,- 145,-	092394	4720,- 197,-	170788	4720,- 197,-	139877	3880,- 162,-	117691	5290,- 221,-	170900
madlo / klika L	Kč €	3460,- 145,-	092400	4720,- 197,-	170795	4720,- 197,-	139884	3880,- 162,-	117707	5290,- 221,-	170917



NRz nerez - broušeno



TiN-K titan černý mat

**Kvadra**

2010,- Kč  
84,- EUR

Kč	materiál: nerezová ocel povrch: NRz nerez - broušeno	EUR
2010,-		84,-
2700,-		113,-
2700,-		113,-
3250,-		136,-
3620,-		151,-
3620,-		151,-



**Entero**

2010,- Kč  
84,- EUR

Kč	materiál: nerezová ocel povrch: NRz nerez - broušeno	EUR
2010,-		84,-
2700,-		113,-
2700,-		113,-
3250,-		136,-
3620,-		151,-
3620,-		151,-

Kliky v kategorii Projekt se vyrábějí jako protipožární a dodávají se včetně protipožárního nerezového čtyřhranu. Pro případ požadavku panikové funkce je třeba objednat variantu z kategorie dveřní kličky NEREZ str. 28 – 39. Dále je třeba objednat dělený čtyřhran a specifikovat přesnou délku čtyřhranu str. 369. Magnetické rozety se s panikovou funkcí nedodávají.

		Magnetická rozeta									
		Objekt						Projekt tř. 4 (i protipožární)			
		NRz		TiN-K		K-industrial		NRz		TiN-K	
		cena / pár	EAN	cena / pár	EAN	cena / pár	EAN	cena / pár	EAN	cena / pár	EAN
klika / klika	Kč €	2010,- 84,-	092714	2860,- 120,-	092776	2860,- 120,-	139891	2430,- 102,-	117899	3420,- 143,-	117950
dozické	Kč €	2700,- 113,-	092721	3950,- 165,-	092783	3950,- 165,-	139907	3110,- 130,-	117905	4520,- 189,-	117967
cyindrické	Kč €	2700,- 113,-	092738	3950,- 165,-	092790	3950,- 165,-	139914	3110,- 130,-	117912	4520,- 189,-	117974
WC	Kč €	3250,- 136,-	092745	4520,- 189,-	092806	4520,- 189,-	139921	3660,- 153,-	117929	5080,- 212,-	117981
madlo / klika R	Kč €	3620,- 151,-	092752	4880,- 204,-	092813	4880,- 204,-	139938	4040,- 169,-	117936	5590,- 233,-	117998
madlo / klika L	Kč €	3620,- 151,-	092769	4880,- 204,-	092820	4880,- 204,-	139945	4040,- 169,-	117943	5590,- 233,-	118001

		Magnetická rozeta									
		Objekt						Projekt tř. 4 (i protipožární)			
		NRz		TiN-K		K-industrial		NRz		TiN-K	
		cena / pár	EAN	cena / pár	EAN	cena / pár	EAN	cena / pár	EAN	cena / pár	EAN
klika / klika	Kč €	2010,- 84,-	092592	2860,- 120,-	092653	2860,- 120,-	139952	2430,- 102,-	117776	3420,- 143,-	117837
dozické	Kč €	2700,- 113,-	092608	3950,- 165,-	092660	3950,- 165,-	139969	3110,- 130,-	117783	4520,- 189,-	117844
cyindrické	Kč €	2700,- 113,-	092615	3950,- 165,-	092677	3950,- 165,-	139976	3110,- 130,-	117790	4520,- 189,-	117851
WC	Kč €	3250,- 136,-	092622	4520,- 189,-	092684	4520,- 189,-	139983	3660,- 153,-	117806	5080,- 212,-	117868
madlo / klika R	Kč €	3620,- 151,-	092639	4880,- 204,-	092691	4880,- 204,-	139990	4040,- 169,-	117813	6380,- 266,-	117875
madlo / klika L	Kč €	3620,- 151,-	092646	4880,- 204,-	092707	4880,- 204,-	140002	4040,- 169,-	117820	6380,- 266,-	117882



NRz nerez - broušeno

**Techno**

2010,- Kč  
84,- EUR

materiál: nerezová ocel  
Kč povrch: NRz nerez - broušeno EUR

Kč	materiál: nerezová ocel povrch: NRz nerez - broušeno	EUR
2010,-		84,-
2700,-		113,-
2700,-		113,-
3250,-		136,-
3620,-		151,-
3620,-		151,-



**Cesan**

1850,- Kč  
78,- EUR

materiál: nerezová ocel  
Kč povrch: NRz nerez - broušeno EUR

Kč	materiál: nerezová ocel povrch: NRz nerez - broušeno	EUR
1850,-		78,-
2530,-		106,-
2530,-		106,-
3100,-		130,-
3460,-		145,-
3460,-		145,-



Kliky v kategorii Projekt se vyrábějí jako protipožární a dodávají se včetně protipožárního nerezového čtyřhranu. Pro případ požadavku panikové funkce je třeba objednat variantu z kategorie dveřní kličky NEREZ str. 28 – 39. Dále je třeba objednat dělený čtyřhran a specifikovat přesnou délku čtyřhranu str. 369. Magnetické rozety se s panikovou funkcí nedodávají.

	Magnetická rozeta										
	Objekt						Projekt tř. 4 (i protipožární)				
	NRz		TiN-K		K-industrial		NRz		TiN-K		
	cena / pár	EAN	cena / pár	EAN	cena / pár	EAN	cena / pár	EAN	cena / pár	EAN	
klika / klika	Kč €	2010,- 84,-	092837			2860,- 120,-	140019	2430,- 102,-	118018		
dozické	Kč €	2700,- 113,-	092844			3950,- 165,-	140026	3110,- 130,-	118025		
cyklindrické	Kč €	2700,- 113,-	092851			3950,- 165,-	140033	3110,- 130,-	118032		
WC	Kč €	3250,- 136,-	092868			4510,- 188,-	140040	3660,- 153,-	118049		
madlo / klika R	Kč €	3620,- 151,-	092875			4880,- 204,-	140057	4040,- 169,-	118056		
madlo / klika L	Kč €	3620,- 151,-	092882			4880,- 204,-	140064	4040,- 169,-	118063		

	Magnetická rozeta										
	Objekt						Projekt tř. 4 (i protipožární)				
	NRz		TiN-K		K-industrial		NRz		TiN-K		
	cena / pár	EAN	cena / pár	EAN	cena / pár	EAN	cena / pár	EAN	cena / pár	EAN	
klika / klika	Kč €	1850,- 78,-	092950	2710,- 113,-	093018	2710,- 113,-	140071	2270,- 95,-	118070	3260,- 136,-	118131
dozické	Kč €	2530,- 106,-	092967	3810,- 159,-	093025	3810,- 159,-	140088	2950,- 123,-	118087	4370,- 183,-	118148
cyklindrické	Kč €	2530,- 106,-	092974	3810,- 159,-	093032	3810,- 159,-	140095	2950,- 123,-	118094	4370,- 183,-	118155
WC	Kč €	3100,- 130,-	092981	4370,- 183,-	093049	4370,- 183,-	140101	3510,- 147,-	118100	4920,- 205,-	118162
madlo / klika R	Kč €	3460,- 145,-	092998	4730,- 198,-	093056	4730,- 198,-	140018	3880,- 162,-	118117	5290,- 221,-	118179
madlo / klika L	Kč €	3460,- 145,-	093001	4730,- 198,-	093063	4730,- 198,-	140125	3880,- 162,-	118124	5290,- 221,-	118186

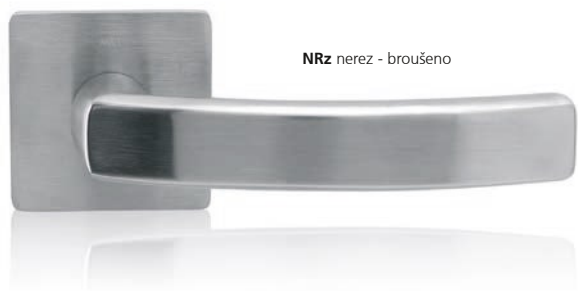

NRz nerez - broušeno

**Sonia**

1570,- Kč  
66,- EUR

Kč	materiál: nerezová ocel povrch: NRz nerez - broušeno	EUR
1570,-		66,-
2250,-		94,-
2250,-		94,-
2820,-		118,-
3350,-		140,-
3350,-		140,-



TiN-K titan černý mat



**Hanna**

2010,- Kč  
84,- EUR

Kč	materiál: nerezová ocel povrch: NRz nerez - broušeno	EUR
2010,-		84,-
2700,-		113,-
2700,-		113,-
3250,-		136,-
3620,-		151,-
3620,-		151,-



Kliky v kategorii Projekt se vyrábějí jako protipožární a dodávají se včetně protipožárního nerezového čtyřhranu. Pro případ požadavku panikové funkce je třeba objednat variantu z kategorie dveřní kličky NEREZ str. 28 – 39. Dále je třeba objednat dělený čtyřhran a specifikovat přesnou délku čtyřhranu str. 369. Magnetické rozety se s panikovou funkcí nedodávají.

	Magnetická rozeta										
	Objekt							Projekt tř. 4 (i protipožární)			
	NRz		TiN-K		K-industrial		NRz		TiN-K		
	cena / pár	EAN	cena / pár	EAN	cena / pár	EAN	cena / pár	EAN	cena / pár	EAN	
klika / klika	Kč €	1570,- 66,-	103359	2520,- 105,-	103410	2520,- 105,-	140132	2000,- 84,-	118193	3070,- 128,-	118254
dozické	Kč €	2250,- 94,-	103366	3650,- 153,-	103427	3650,- 153,-	140149	2670,- 112,-	118209	4230,- 177,-	118261
cyklindrické	Kč €	2250,- 94,-	103373	3650,- 153,-	103434	3650,- 153,-	140156	2670,- 112,-	118216	4230,- 177,-	118278
WC	Kč €	2820,- 118,-	103380	4230,- 177,-	103441	4230,- 177,-	140163	3240,- 135,-	118223	4800,- 200,-	118285
madlo / klika R	Kč €	3350,- 140,-	103397	4750,- 198,-	103458	4750,- 198,-	140170	3760,- 157,-	118230	5320,- 222,-	118292
madlo / klika L	Kč €	3350,- 140,-	103403	4750,- 198,-	103465	4750,- 198,-	140187	3760,- 157,-	118247	5320,- 222,-	118308

	Magnetická rozeta										
	Objekt							Projekt tř. 4 (i protipožární)			
	NRz		TiN-K		K-industrial		NRz		TiN-K		
	cena / pár	EAN	cena / pár	EAN	cena / pár	EAN	cena / pár	EAN	cena / pár	EAN	
klika / klika	Kč €	2010,- 84,-	115208	2860,- 120,-	115260	2860,- 120,-	140194	2430,- 102,-	118315	3420,- 143,-	118377
dozické	Kč €	2700,- 113,-	115215	3950,- 165,-	115277	3950,- 165,-	140200	3110,- 130,-	118322	4520,- 189,-	118384
cyklindrické	Kč €	2700,- 113,-	115222	3950,- 165,-	115284	3950,- 165,-	140217	3110,- 130,-	118339	4520,- 189,-	118391
WC	Kč €	3250,- 136,-	115239	4520,- 189,-	115291	4520,- 189,-	140224	3660,- 153,-	118346	5080,- 212,-	118407
madlo / klika R	Kč €	3620,- 151,-	115246	4880,- 204,-	115307	4880,- 204,-	140231	4040,- 169,-	118353	5460,- 228,-	118414
madlo / klika L	Kč €	3620,- 151,-	115253	4880,- 204,-	115314	4880,- 204,-	140248	4040,- 169,-	118360	5460,- 228,-	118421



Celý projekt - jeden design

Dveřní kliky DESIGN 2000, 2004



Kování pro hliníkové a ocelové dveře, kování na branky



Kliky a zámky na skleněné dveře



Panty na skleněné dveře



Madla a koule na skleněné a dřevěné dveře



Mušle na posuvné dveře



Panty na dřevěné dveře



Bezpečnostní rozety



Okenní kliky 3 a 4 polohové



Bezpečnostní madla Entero



Madla dlouhá





## Dveřní kliky DESIGN 2000, 2004

Materiál: masivní mosaz 

Povrchy: SNI, SNI - broušeno, Cr, TiN-C, TiN-K, Ms, Ms-L, Ms-A, zakázkově TiN-S, TiN-A  
více info na [www.kliky-mt.cz/manufaktura/barvy-povrchy](http://www.kliky-mt.cz/manufaktura/barvy-povrchy)

Kování vyráběné od roku 2000 na kulatých rozetách a od roku 2004 na čtvercových rozetách, kdy se jednalo o první kolekci klik na hranatých rozetách v Evropě. Lídrem celé kolekce je klika Entero, která už více jak 18 let patří k nejoblíbenějším klikám v nabídce M&T díky svému tvaru, dokonalé ergonomii a jednoduché, ale zároveň kvalitní montáži. Tento typ konstrukce a montáže je velkou předností celé kolekce klik DESIGN 2000 a 2004.

SOGUT **SNI** matný nikl

ENTERO **SNI-broušeno** matný nikl broušeno



Klika/klika + rozety kulaté dozické

Klika/klika + rozety kulaté cylindrické

Klika/klika + rozety kulaté WC

Koule/klika R + rozety kulaté cylindrické

Koule/klika L + rozety kulaté cylindrické

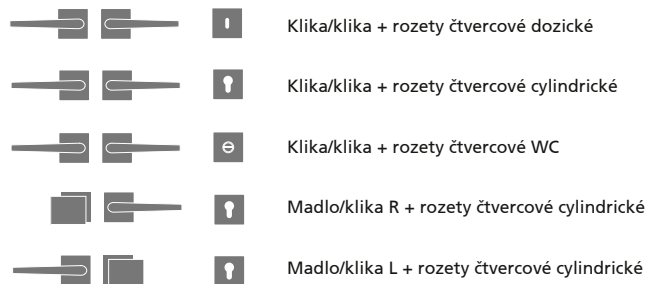

Klika/klika + rozety čtvercové dozické

Klika/klika + rozety čtvercové cylindrické

Klika/klika + rozety čtvercové WC

Madlo/klika R + rozety čtvercové cylindrické

Madlo/klika L + rozety čtvercové cylindrické



dozické

cylindrické

WC in

WC ex

koule Maty



zaslepovací

rozety Ø 52 mm



koule Fábi



dozické

cylindrické

WC in

WC ex

zaslepovací

rozety 52x52 mm



madlo Entero

konstrukční varianty, materiálové provedení

- kování s vratnou pružinou
- sada vč. spodních rozet
- sešroubování pouzdry proti sobě
- rukojeti vyrobeny z masivní mosazi
- zajišťovací gel proti uvolnění šroubů
- vrtání PROFI šablonou M&T vrtákem Ø 6,4 mm
- animace montáže na [www.kliky-mt.cz/montaze-kovani](http://www.kliky-mt.cz/montaze-kovani)
- montáž pro tloušťky dveří 38 – 126 mm
- možnost dodání v protipožárním provedení
- v balení standardně montážní materiál pro tl. dveří 38 - 45 mm
- záruka 3 roky, titany 15 let, mosaz natural doživotní

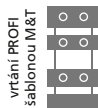

Ochranná známka – registrovaná značka

**ENTERO®**

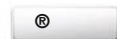

Chráněné průmyslové vzory klik



**ENTERO**  
**BURAK**  
**MIA**  
**SOGUT**

roky **3 garance** let **15 garance**



SNi matný nikel

**Cesan**

1490,- Kč  
63,- EUR



TIN-K titan černý mat

**Garanti**

1550,- Kč  
65,- EUR



Cr lesklý chrom

**Burak**

1620,- Kč  
68,- EUR



SNi matný nikel

**Fábi**

1780,- Kč  
75,- EUR



Ms mosaz natural

**Andy**

1780,- Kč  
75,- EUR



SNi matný nikel

**Mondeo**

2140,- Kč  
90,- EUR

Kč	materiál: masivní mosaz povrch: SNi matný nikel			EUR
1490,-				63,-
1490,-				63,-
2250,-				94,-
2360,-				99,-
2360,-				99,-
1550,-				65,-
1550,-				65,-
2310,-				97,-
2410,-				101,-
2410,-				101,-
1620,-				68,-
1620,-				68,-
2380,-				100,-
2470,-				103,-
2470,-				103,-
1780,-				75,-
1780,-				75,-
2540,-				106,-
2640,-				110,-
2640,-				110,-
1780,-				75,-
1780,-				75,-
2540,-				106,-
2640,-				110,-
2640,-				110,-
2140,-				90,-
2140,-				90,-
2890,-				121,-
2970,-				124,-
2970,-				124,-

Povrchy TIN-S, TIN-A, Ms-L, Ms-A – více na [www.kliky-mt.cz/katalog](http://www.kliky-mt.cz/katalog)  
Protipožární provedení (kovové podrozety + nerezové spojovací prvky, čtyřhran) ... příplatek 520,- Kč ... EAN 082289  
Provedení panikové pro zámky s děleným čtyřhranem je s příplatkem 280,- Kč (EAN 101409) k ceně provedení klika / klika.  
Dělený čtyřhran se objednává zvlášť a je třeba specifikovat přesnou délku čtyřhranu, str. 369.



		SNI		Cr		Ms		Ms-A		TiN-C		TiN-K	
		cena pár	EAN	cena pár	EAN	cena pár	EAN	cena pár	EAN	cena pár	EAN	cena pár	EAN
dozické	Kč €	1490,- 63,-	20252	1830,- 77,-	20610	1830,- 77,-	050356	2010,- 84,-	096101	2810,- 118,-	21105	2810,- 118,-	20344
cyldrické	Kč €	1490,- 63,-	20269	1830,- 77,-	20627	1830,- 77,-	050363	2010,- 84,-	096118	2810,- 118,-	21112	2810,- 118,-	20351
WC	Kč €	2250,- 94,-	20276	2590,- 108,-	20634	2590,- 108,-	050370	2850,- 119,-	096125	3730,- 156,-	21099	3730,- 156,-	20368
koule / klika R	Kč €	2360,- 99,-	20900	2700,- 113,-	20924	2700,- 113,-	050387	2950,- 123,-	096132	3840,- 160,-	20962	3840,- 160,-	20986
koule / klika L	Kč €	2360,- 99,-	20917	2700,- 113,-	20931	2700,- 113,-	050394	2950,- 123,-	096149	3840,- 160,-	20979	3840,- 160,-	20993
dozické	Kč €	1550,- 65,-	20375	1870,- 78,-	20764	1870,- 78,-	050509	2060,- 86,-	096200	2870,- 120,-	21129	2870,- 120,-	20467
cyldrické	Kč €	1550,- 65,-	20382	1870,- 78,-	20771	1870,- 78,-	050516	2060,- 86,-	096217	2870,- 120,-	21136	2870,- 120,-	20474
WC	Kč €	2310,- 97,-	20399	2630,- 110,-	20788	2630,- 110,-	050523	2890,- 121,-	096224	3800,- 159,-	20429	3800,- 159,-	20481
koule / klika R	Kč €	2410,- 101,-	20801	2730,- 114,-	20825	2730,- 114,-	050530	2990,- 125,-	096231	3880,- 162,-	20863	3880,- 162,-	20887
koule / klika L	Kč €	2410,- 101,-	20818	2730,- 114,-	20832	2730,- 114,-	050547	2990,- 125,-	096248	3880,- 162,-	20870	3880,- 162,-	20894
dozické	Kč €	1620,- 68,-	20498	1940,- 81,-	20641	1940,- 81,-	050653	2140,- 90,-	096057	2930,- 123,-	21303	2930,- 123,-	20580
cyldrické	Kč €	1620,- 68,-	20504	1940,- 81,-	20658	1940,- 81,-	050660	2140,- 90,-	096064	2930,- 123,-	21310	2930,- 123,-	20597
WC	Kč €	2380,- 100,-	20511	2710,- 113,-	20665	2710,- 113,-	050677	2960,- 124,-	096071	3850,- 161,-	21327	3850,- 161,-	20603
koule / klika R	Kč €	2470,- 103,-	23307	2810,- 118,-	23321	2810,- 118,-	050684	3090,- 129,-	096088	3950,- 165,-	23369	3950,- 165,-	23383
koule / klika L	Kč €	2470,- 103,-	23314	2810,- 118,-	23338	2810,- 118,-	050691	3090,- 129,-	096095	3950,- 165,-	23376	3950,- 165,-	23390
dozické	Kč €	1780,- 75,-	23840	2100,- 88,-	23871	2100,- 88,-	050806	2320,- 97,-	096156	3100,- 130,-	23932	3100,- 130,-	23963
cyldrické	Kč €	1780,- 75,-	23857	2100,- 88,-	23888	2100,- 88,-	050813	2320,- 97,-	096163	3100,- 130,-	23949	3100,- 130,-	23970
WC	Kč €	2540,- 106,-	23864	2870,- 120,-	23895	2870,- 120,-	050820	3150,- 132,-	096170	4030,- 168,-	23956	4030,- 168,-	23987
koule / klika R	Kč €	2640,- 110,-	32255	2960,- 124,-	32279	2960,- 124,-	050837	3260,- 136,-	096187	4130,- 173,-	32316	4130,- 173,-	32330
koule / klika L	Kč €	2640,- 110,-	32262	2960,- 124,-	32286	2960,- 124,-	050844	3260,- 136,-	096194	4130,- 173,-	32323	4130,- 173,-	32347
dozické	Kč €	1780,- 75,-	60005	2100,- 88,-	60050	2100,- 88,-	050950	2320,- 97,-	096002	3100,- 130,-	60159	3100,- 130,-	60203
cyldrické	Kč €	1780,- 75,-	60012	2100,- 88,-	60067	2100,- 88,-	050967	2320,- 97,-	096019	3100,- 130,-	60166	3100,- 130,-	60210
WC	Kč €	2540,- 106,-	60029	2870,- 120,-	60074	2870,- 120,-	050974	3150,- 132,-	096026	4030,- 168,-	60173	4030,- 168,-	60227
koule / klika R	Kč €	2640,- 110,-	60036	2960,- 124,-	60081	2960,- 124,-	050981	3260,- 136,-	096033	4130,- 173,-	60180	4130,- 173,-	60234
koule / klika L	Kč €	2640,- 110,-	60043	2960,- 124,-	60098	2960,- 124,-	050998	3260,- 136,-	096040	4130,- 173,-	60197	4130,- 173,-	60241
dozické	Kč €	2140,- 90,-	60302	2460,- 103,-	60357	2460,- 103,-	051100	2710,- 113,-	096255	3440,- 144,-	60456	3440,- 144,-	60500
cyldrické	Kč €	2140,- 90,-	60319	2460,- 103,-	60364	2460,- 103,-	051117	2710,- 113,-	096262	3440,- 144,-	60463	3440,- 144,-	60517
WC	Kč €	2890,- 121,-	60326	3210,- 134,-	60371	3210,- 134,-	051124	3520,- 147,-	096279	4370,- 183,-	60470	4370,- 183,-	60524
koule / klika R	Kč €	2970,- 124,-	60333	3320,- 139,-	60388	3320,- 139,-	051131	3640,- 152,-	096286	4460,- 186,-	60487	4460,- 186,-	60531
koule / klika L	Kč €	2970,- 124,-	60340	3320,- 139,-	60395	3320,- 139,-	051148	3640,- 152,-	096293	4460,- 186,-	60494	4460,- 186,-	60548

U kombinace koule / klika dodáváme standardně kouli Fábi pevnou - neotočnou. Na základě požadavku kouli Maty pevnou - neotočnou. Lze dodat kouli Fábi otočnou s funkcí kliky. V balení je standardně montážní materiál pro tl. dveří 38 - 45 mm. Pro větší tloušťky dveří je potřeba specifikovat jiný montážní materiál viz. Příslušenství a komponenty str. 368.



SNi matný nikl

**Kemer**

1960,- Kč  
82,- EUR



Cr lesklý chrom

**Deny**

1620,- Kč  
68,- EUR



TiN-C titan chrom mat

**Lusy**

1620,- Kč  
68,- EUR



SNi matný nikl

**Maty**

2140,- Kč  
90,- EUR

Kč	materiál: masivní mosaz povrch: SNi matný nikl			EUR
1960,-				82,-
1960,-				82,-
3710,-				113,-
2820,-				118,-
2820,-				118,-
1620,-				68,-
1620,-				68,-
2400,-				100,-
2470,-				103,-
2470,-				103,-
1620,-				68,-
1620,-				68,-
2400,-				100,-
2470,-				103,-
2470,-				103,-
2140,-				90,-
2140,-				90,-
2910,-				122,-
2970,-				124,-
2970,-				124,-



		SNI		Cr		Ms		Ms-A		TiN-C		TiN-K	
		cena pár	EAN	cena pár	EAN	cena pár	EAN	cena pár	EAN	cena pár	EAN	cena pár	EAN
dozické	Kč €	1960,- 82,-	21808	2290,- 96,-	20733	2290,- 96,-	051254	2520,- 105,-	096354	3270,- 137,-	21860	3270,- 137,-	21891
cylindrické	Kč €	1960,- 82,-	21815	2290,- 96,-	20740	2290,- 96,-	051261	2520,- 105,-	096361	3270,- 137,-	21877	3270,- 137,-	21907
WC	Kč €	2710,- 113,-	21822	3040,- 127,-	20757	3040,- 127,-	051278	3330,- 139,-	096378	4180,- 175,-	21921	4180,- 175,-	21914
koule / klika R	Kč €	2820,- 118,-	23406	3150,- 132,-	23420	3150,- 132,-	051285	3460,- 145,-	096385	4310,- 180,-	23468	4310,- 180,-	23482
koule / klika L	Kč €	2820,- 118,-	23413	3150,- 132,-	23437	3150,- 132,-	051292	3460,- 145,-	096392	4310,- 180,-	23475	4310,- 180,-	23499
dozické	Kč €	1620,- 68,-	23062	1940,- 81,-	23093	1940,- 81,-	051407	2140,- 90,-	096309	2930,- 123,-	32651	2930,- 123,-	32705
cylindrické	Kč €	1620,- 68,-	23079	1940,- 81,-	23109	1940,- 81,-	051414	2140,- 90,-	096316	2930,- 123,-	32668	2930,- 123,-	32712
WC	Kč €	2400,- 100,-	23086	2720,- 114,-	23116	2720,- 114,-	051421	2970,- 124,-	096323	3860,- 161,-	32675	3860,- 161,-	32729
koule / klika R	Kč €	2470,- 103,-	23642	2810,- 118,-	23666	2810,- 118,-	051438	3090,- 129,-	096330	3950,- 165,-	32682	3950,- 165,-	32736
koule / klika L	Kč €	2470,- 103,-	23659	2810,- 118,-	23673	2810,- 118,-	051445	3090,- 129,-	096347	3950,- 165,-	32699	3950,- 165,-	32743
dozické	Kč €	1620,- 68,-	23178	1940,- 81,-	23246	1940,- 81,-	051551	2140,- 90,-	096408	2930,- 123,-	32552	2930,- 123,-	25905
cylindrické	Kč €	1620,- 68,-	23185	1940,- 81,-	23253	1940,- 81,-	051568	2140,- 90,-	096415	2930,- 123,-	32569	2930,- 123,-	25912
WC	Kč €	2400,- 100,-	23192	2720,- 114,-	23260	2720,- 114,-	051575	2970,- 124,-	096422	3860,- 161,-	32576	3860,- 161,-	25929
koule / klika R	Kč €	2470,- 103,-	23604	2810,- 118,-	23628	2810,- 118,-	051582	3090,- 129,-	096439	3950,- 165,-	32583	3950,- 165,-	25936
koule / klika L	Kč €	2470,- 103,-	23611	2810,- 118,-	23635	2810,- 118,-	051599	3090,- 129,-	096446	3950,- 165,-	32590	3950,- 165,-	25943
dozické	Kč €	2140,- 90,-	20016	2460,- 103,-	20061	2460,- 103,-	051704	2710,- 113,-	096453	3440,- 144,-	20160	3440,- 144,-	20214
cylindrické	Kč €	2140,- 90,-	20023	2460,- 103,-	20078	2460,- 103,-	051711	2710,- 113,-	096460	3440,- 144,-	20177	3440,- 144,-	20221
WC	Kč €	2910,- 122,-	20030	3220,- 135,-	20085	3220,- 135,-	051728	3530,- 148,-	096477	4380,- 183,-	20184	4380,- 183,-	20238
koule / klika R	Kč €	2970,- 124,-	20047	3320,- 139,-	20092	3320,- 139,-	051735	3640,- 152,-	096484	4460,- 186,-	20191	4460,- 186,-	20245
koule / klika L	Kč €	2970,- 124,-	20054	3320,- 139,-	20108	3320,- 139,-	051742	3640,- 152,-	096491	4460,- 186,-	20207	4460,- 186,-	20306

V balení je standardně montážní materiál pro tl. dveří 38 - 45 mm. Pro větší tloušťky dveří je potřeba specifikovat jiný montážní materiál viz. Příslušenství a komponenty str. 368.



TIN-K titan černý mat

**Mia**

1620,- Kč  
68,- EUR



SNi matný nikl

**Sogut**

1880,- Kč  
79,- EUR



**Meclis**

1640,- Kč  
69,- EUR



**Cherez**

2400,- Kč  
100,- EUR

Kč	materiál: masivní mosaz povrch: SNi matný nikl			EUR
1620,-				68,-
1620,-				68,-
2400,-				100,-
2470,-				103,-
2470,-				103,-
1880,-				79,-
1880,-				79,-
2650,-				111,-
2770,-				116,-
2770,-				116,-
1640,-				69,-
1640,-				69,-
2420,-				101,-
2530,-				106,-
2530,-				106,-
2400,-				100,-
2400,-				100,-
3300,-				138,-
3570,-				149,-
3570,-				149,-
340,-				15,-

Povrchy TIN-S, TIN-A, Ms-L, Ms-A – více na [www.kliky-mt.cz/katalog](http://www.kliky-mt.cz/katalog)  
 Protipožární provedení (kovové podrozety + nerezové spojovací prvky, čtyřhran) ... příplatek 520,- Kč ... EAN 082289  
 Provedení panikové pro zámky s děleným čtyřhranem je s příplatkem 280,- Kč (EAN 101409) k ceně provedení klika / klika.  
 Dělený čtyřhran se objednává zvlášť a je třeba specifikovat přesnou délku čtyřhranu, str. 369.



		SNI		Cr		Ms		Ms-A		TiN-C		TiN-K	
		cena pár	EAN	cena pár	EAN	cena pár	EAN	cena pár	EAN	cena pár	EAN	cena pár	EAN
dozické	Kč €	1620,- 68,-	23703	1940,- 81,-	23758	1940,- 81,-	051858	2140,- 90,-	096606	2930,- 123,-	25806	2930,- 123,-	25851
cylindrické	Kč €	1620,- 68,-	23710	1940,- 81,-	23765	1940,- 81,-	051865	2140,- 90,-	096613	2930,- 123,-	25813	2930,- 123,-	25868
WC	Kč €	2400,- 100,-	23727	2720,- 114,-	23772	2720,- 114,-	051872	2970,- 124,-	096620	3860,- 161,-	25820	3860,- 161,-	25875
koule / klika R	Kč €	2470,- 103,-	23734	2810,- 118,-	23789	2810,- 118,-	051889	3090,- 129,-	096637	3950,- 165,-	25837	3950,- 165,-	25882
koule / klika L	Kč €	2470,- 103,-	23741	2810,- 118,-	23796	2810,- 118,-	051896	3090,- 129,-	096644	3950,- 165,-	25844	3950,- 165,-	25899
dozické	Kč €	1880,- 79,-	21501	2220,- 93,-	32156	2220,- 93,-	052008	2430,- 102,-	096651	3210,- 134,-	32200	3210,- 134,-	21587
cylindrické	Kč €	1880,- 79,-	21518	2220,- 93,-	32163	2220,- 93,-	052015	2430,- 102,-	096668	3210,- 134,-	32217	3210,- 134,-	21594
WC	Kč €	2650,- 111,-	21525	2970,- 124,-	32170	2970,- 124,-	052022	3270,- 137,-	096675	4140,- 173,-	32224	4140,- 173,-	21600
koule / klika R	Kč €	2770,- 116,-	23505	3110,- 130,-	32187	3110,- 130,-	052039	3420,- 143,-	096682	4240,- 177,-	32231	4240,- 177,-	23543
koule / klika L	Kč €	2770,- 116,-	23512	3110,- 130,-	32194	3110,- 130,-	052046	3420,- 143,-	096699	4240,- 177,-	32248	4240,- 177,-	23550
dozické	Kč €	1640,- 69,-	21709	1820,- 76,-	21730	1820,- 76,-	052152	2000,- 84,-	096552	3130,- 131,-	32408	3130,- 131,-	32453
cylindrické	Kč €	1640,- 69,-	21716	1820,- 76,-	21747	1820,- 76,-	052169	2000,- 84,-	096569	3130,- 131,-	32415	3130,- 131,-	32460
WC	Kč €	2420,- 101,-	21723	2740,- 115,-	21754	2740,- 115,-	052176	3030,- 127,-	096576	4080,- 170,-	32422	4080,- 170,-	32477
koule / klika R	Kč €	2530,- 106,-	23802	2860,- 120,-	23826	2860,- 120,-	052183	3140,- 131,-	096583	4160,- 174,-	32439	4160,- 174,-	32484
koule / klika L	Kč €	2530,- 106,-	23819	2860,- 120,-	23833	2860,- 120,-	052190	3140,- 131,-	096590	4160,- 174,-	32446	4160,- 174,-	32491
dozické	Kč €	2400,- 100,-	66007	2720,- 114,-	66052	2720,- 114,-	052305	2970,- 124,-	096507	3700,- 155,-	66151	3700,- 155,-	66205
cylindrické	Kč €	2400,- 100,-	66014	2720,- 114,-	66069	2720,- 114,-	052312	2970,- 124,-	096514	3700,- 155,-	66168	3700,- 155,-	66212
WC	Kč €	3300,- 138,-	66021	3630,- 152,-	66076	3630,- 152,-	052329	3990,- 167,-	096521	4800,- 200,-	66175	4800,- 200,-	66229
koule / klika R	Kč €	3570,- 149,-	66038	3880,- 162,-	66083	3880,- 162,-	052336	4280,- 179,-	096538	5040,- 210,-	66182	5040,- 210,-	66236
koule / klika L	Kč €	3570,- 149,-	66045	3880,- 162,-	66090	3880,- 162,-	052343	4280,- 179,-	096545	5040,- 210,-	66199	5040,- 210,-	66243
rozeta zaslepovací	Kč €	340,- 15,-	63990	430,- 18,-	64003	600,- 25,-	052350	650,- 28,-	101737	660,- 28,-	64027	660,- 28,-	64034

V balení je standardně montážní materiál pro tl. dveří 38 - 45 mm. Pro větší tloušťky dveří je potřeba specifikovat jiný montážní materiál viz. Příslušenství a komponenty str. 368.



**Entero madlo**  
s funkcí klika/klika

3590,- Kč  
150,- EUR

SNi - broušeno



Ms mosaz natural

**Entero**

2960,- Kč  
124,- EUR



SNi matný nikl



**Lara**

2630,- Kč  
110,- EUR



**Sogut**

2530,- Kč  
106,- EUR



TIN-C titan chrom mat

**Garanti**

1870,- Kč  
78,- EUR

**Kč** materiál: masivní mosaz  
povrch: SNi matný nikl **EUR**

3590,-    150,-

3590,-    150,-

4440,-    185,-

4700,-    196,-

4700,-    196,-

2960,-    124,-

2960,-    124,-

3850,-    161,-

4110,-    172,-

4110,-    172,-

2630,-    110,-

2630,-    110,-

3520,-    147,-

3800,-    159,-

3800,-    159,-

2530,-    106,-

2530,-    106,-

3420,-    143,-

3660,-    153,-

3660,-    153,-

1870,-    78,-

1870,-    78,-

2810,-    118,-

3060,-    128,-

3060,-    128,-

Povrchy TIN-S, TIN-A, Ms-L, Ms-A – více na [www.kliky-mt.cz/katalog](http://www.kliky-mt.cz/katalog)  
Protipožární provedení (kovové podrozety + nerezové spojovací prvky, čtyřhran) ... příplatek 520,- Kč ... EAN 082289  
Provedení paníkové pro zámky s děleným čtyřhranem je s příplatkem 280,- Kč (EAN 101409) k ceně provedení klika / klika.  
Dělený čtyřhran se objednává zvlášť a je třeba specifikovat přesnou délku čtyřhranu, str. 369.





		SNI		SNI - broušeno		Cr		Ms		Ms-A		TiN-C		TiN-K	
		cena pár	EAN	cena pár	EAN	cena pár	EAN	cena pár	EAN	cena pár	EAN	cena pár	EAN	cena pár	EAN
dozické	Kč €			3590,- 150,-	68483	3910,- 163,-	68537	3910,- 163,-	052480	4290,- 179,-	096750	4880,- 204,-	68636	4880,- 204,-	68681
cyldrické	Kč €			3590,- 150,-	68490	3910,- 163,-	68544	3910,- 163,-	052497	4290,- 179,-	096767	4880,- 204,-	68643	4880,- 204,-	68698
WC	Kč €			4440,- 185,-	68506	4800,- 200,-	68551	4800,- 200,-	052503	5270,- 220,-	096774	5930,- 248,-	68650	5930,- 248,-	68704
pevné / otočné R	Kč €			4700,- 196,-	68513	5040,- 210,-	68568	5040,- 210,-	052510	5540,- 231,-	096781	6180,- 258,-	68667	6180,- 258,-	68711
pevné / otočné L	Kč €			4700,- 196,-	68520	5040,- 210,-	68575	5040,- 210,-	052527	5540,- 231,-	096798	6180,- 258,-	68674	6180,- 258,-	68728
dozické	Kč €	2960,- 124,-	087239	3090,- 129,-	66304	3410,- 143,-	66359	3410,- 143,-	052633	3740,- 156,-	096705	4390,- 183,-	66458	4390,- 183,-	66502
cyldrické	Kč €	2960,- 124,-	087246	3090,- 129,-	66311	3410,- 143,-	66366	3410,- 143,-	052640	3740,- 156,-	096712	4390,- 183,-	66465	4390,- 183,-	66519
WC	Kč €	3850,- 161,-	087253	3950,- 165,-	66328	4300,- 180,-	66373	4300,- 180,-	052657	4720,- 197,-	096729	5430,- 227,-	66472	5430,- 227,-	66526
madlo / klika R	Kč €	4110,- 172,-	087260	4200,- 175,-	66335	4540,- 190,-	66380	4540,- 190,-	052664	5000,- 209,-	096736	5700,- 238,-	66489	5700,- 238,-	66533
madlo / klika L	Kč €	4110,- 172,-	087277	4200,- 175,-	66342	4540,- 190,-	66397	4540,- 190,-	052671	5000,- 209,-	096743	5700,- 238,-	66496	5700,- 238,-	66540
dozické	Kč €	2630,- 110,-	087185	2730,- 114,-	66601	3060,- 128,-	66656	3060,- 128,-	052787	3370,- 141,-	096859	4050,- 169,-	66755	4050,- 169,-	66809
cyldrické	Kč €	2630,- 110,-	087192	2730,- 114,-	66618	3060,- 128,-	66663	3060,- 128,-	052794	3370,- 141,-	096866	4050,- 169,-	66762	4050,- 169,-	66816
WC	Kč €	3520,- 147,-	087208	3630,- 152,-	66625	3950,- 165,-	66670	3950,- 165,-	052800	4350,- 182,-	096873	5100,- 213,-	66779	5100,- 213,-	66823
madlo / klika R	Kč €	3800,- 159,-	087215	3880,- 162,-	66632	4200,- 175,-	66687	4200,- 175,-	052817	4630,- 193,-	096880	5370,- 224,-	66786	5370,- 224,-	66830
madlo / klika L	Kč €	3800,- 159,-	087222	3880,- 162,-	66649	4200,- 175,-	66694	4200,- 175,-	052824	4630,- 193,-	096897	5370,- 224,-	66793	5370,- 224,-	66847
dozické	Kč €	2530,- 106,-	67820			2860,- 120,-	67875	2860,- 120,-	052930	3140,- 131,-	096903	3840,- 160,-	67974	3840,- 160,-	68025
cyldrické	Kč €	2530,- 106,-	67837			2860,- 120,-	67882	2860,- 120,-	052947	3140,- 131,-	096910	3840,- 160,-	67981	3840,- 160,-	68032
WC	Kč €	3420,- 143,-	67844			3740,- 156,-	67899	3740,- 156,-	052954	4110,- 172,-	096927	4900,- 205,-	67998	4900,- 205,-	68049
madlo / klika R	Kč €	3660,- 153,-	67851			3990,- 167,-	67905	3990,- 167,-	052961	4390,- 183,-	096934	5150,- 215,-	68001	5150,- 215,-	68056
madlo / klika L	Kč €	3660,- 153,-	67868			3990,- 167,-	67912	3990,- 167,-	052978	4390,- 183,-	096941	5150,- 215,-	68018	5150,- 215,-	68063
dozické	Kč €	1870,- 78,-	66922			2210,- 93,-	66977	2210,- 93,-	053081	2420,- 101,-	096804	3200,- 134,-	67073	3200,- 134,-	67127
cyldrické	Kč €	1870,- 78,-	66939			2210,- 93,-	66984	2210,- 93,-	053098	2420,- 101,-	096811	3200,- 134,-	67080	3200,- 134,-	67134
WC	Kč €	2810,- 118,-	66946			3140,- 131,-	66991	3140,- 131,-	053104	3440,- 144,-	096828	4300,- 180,-	67097	4300,- 180,-	67141
madlo / klika R	Kč €	3060,- 128,-	66953			3400,- 142,-	67004	3400,- 142,-	053111	3730,- 156,-	096835	4540,- 190,-	67103	4540,- 190,-	67158
madlo / klika L	Kč €	3060,- 128,-	66960			3400,- 142,-	67011	3400,- 142,-	053128	3730,- 156,-	096842	4540,- 190,-	67110	4540,- 190,-	67165

U kombinace madlo / klika dodáváme standardně madlo Entero pevné - neotočné. Na základě požadavku madlo Entero otočné s funkcí kliky.

V balení je standardně montážní materiál pro tl. dveří 38 - 45 mm. Pro větší tloušťky dveří je potřeba specifikovat jiný montážní materiál viz. Příslušenství a komponenty str. 368.



SNi matný nikel

**Lusy**

2060,- Kč  
86,- EUR



TIN-K titan černý mat

**Deny**

2060,- Kč  
86,- EUR



**Cherez**

2910,- Kč  
122,- EUR



**Mondeo**

2570,- Kč  
108,- EUR

Kč	materiál: masivní mosaz povrch: SNi matný nikel			EUR
2060,-				86,-
2060,-				86,-
2960,-				124,-
3220,-				135,-
3220,-				135,-
2060,-				86,-
2060,-				86,-
2960,-				124,-
3220,-				135,-
3220,-				135,-
2910,-				122,-
2910,-				122,-
3810,-				159,-
4050,-				169,-
4050,-				169,-
2570,-				108,-
2570,-				108,-
3460,-				145,-
3710,-				155,-
3710,-				155,-
430,-				18,-

Povrchy TIN-S, TIN-A, Ms-L, Ms-A – více na [www.kliky-mt.cz/katalog](http://www.kliky-mt.cz/katalog)  
 Protipožární provedení (kovové podrozety + nerezové spojovací prvky, čtyřhran) ... příplatek 520,- Kč ... EAN 082289  
 Provedení panikové pro zámky s děleným čtyřhranem je s příplatkem 280,- Kč (EAN 101409) k ceně provedení klika / klika.  
 Dělený čtyřhran se objednává zvlášť a je třeba specifikovat přesnou délku čtyřhranu, str. 369.



		SNI		Cr		Ms		Ms-A		TiN-C		TiN-K	
		cena pár	EAN	cena pár	EAN	cena pár	EAN	cena pár	EAN	cena pár	EAN	cena pár	EAN
dozické	Kč €	2060,- 86,-	67226	2400,- 100,-	67271	2400,- 100,-	053234	2620,- 110,-	097054	3390,- 142,-	67370	3390,- 142,-	67424
cyklindrické	Kč €	2060,- 86,-	67233	2400,- 100,-	67288	2400,- 100,-	053241	2620,- 110,-	097061	3390,- 142,-	67387	3390,- 142,-	67431
WC	Kč €	2960,- 124,-	67240	3300,- 138,-	67295	3300,- 138,-	053258	3630,- 152,-	097078	4440,- 185,-	67394	4440,- 185,-	67448
madlo / klika R	Kč €	3220,- 135,-	67257	3570,- 149,-	67301	3570,- 149,-	053265	3920,- 164,-	097085	4700,- 196,-	67400	4700,- 196,-	67455
madlo / klika L	Kč €	3220,- 135,-	67264	3570,- 149,-	67318	3570,- 149,-	053272	3920,- 164,-	097092	4700,- 196,-	67417	4700,- 196,-	67462
dozické	Kč €	2060,- 86,-	67523	2400,- 100,-	67578	2400,- 100,-	053388	2620,- 110,-	096958	3390,- 142,-	67677	3390,- 142,-	67721
cyklindrické	Kč €	2060,- 86,-	67530	2400,- 100,-	67585	2400,- 100,-	053395	2620,- 110,-	096965	3390,- 142,-	67684	3390,- 142,-	67738
WC	Kč €	2960,- 124,-	67547	3300,- 138,-	67592	3300,- 138,-	053401	3630,- 152,-	096972	4440,- 185,-	67691	4440,- 185,-	67745
madlo / klika R	Kč €	3220,- 135,-	67554	3570,- 149,-	67608	3570,- 149,-	053418	3920,- 164,-	096989	4700,- 196,-	67707	4700,- 196,-	67752
madlo / klika L	Kč €	3220,- 135,-	67561	3570,- 149,-	67615	3570,- 149,-	053425	3920,- 164,-	096996	4700,- 196,-	67714	4700,- 196,-	67769
dozické	Kč €	2910,- 122,-	78413	3220,- 135,-	78468	3220,- 135,-	053531	3530,- 148,-	097009	4200,- 175,-	78567	4200,- 175,-	78611
cyklindrické	Kč €	2910,- 122,-	78420	3220,- 135,-	78475	3220,- 135,-	053548	3530,- 148,-	097016	4200,- 175,-	78574	4200,- 175,-	78628
WC	Kč €	3810,- 159,-	78437	4130,- 173,-	78482	4130,- 173,-	053555	4530,- 189,-	097023	5280,- 220,-	78581	5280,- 220,-	78635
madlo / klika R	Kč €	4050,- 169,-	78444	4380,- 183,-	78499	4380,- 183,-	053562	4820,- 201,-	097030	5530,- 231,-	78598	5530,- 231,-	78642
madlo / klika L	Kč €	4050,- 169,-	78451	4380,- 183,-	78505	4380,- 183,-	053579	4820,- 201,-	097047	5530,- 231,-	78604	5530,- 231,-	78659
dozické	Kč €	2570,- 108,-	74453	2910,- 122,-	74507	2910,- 122,-	053685	3180,- 133,-	097108	3880,- 162,-	74606	3880,- 162,-	74651
cyklindrické	Kč €	2570,- 108,-	74460	2910,- 122,-	74514	2910,- 122,-	053692	3180,- 133,-	097115	3880,- 162,-	74613	3880,- 162,-	74668
WC	Kč €	3460,- 145,-	74477	3810,- 159,-	74521	3810,- 159,-	053708	4180,- 175,-	097122	4930,- 206,-	74620	4930,- 206,-	74675
madlo / klika R	Kč €	3710,- 155,-	74484	4050,- 169,-	74538	4050,- 169,-	053715	4460,- 186,-	097139	5200,- 217,-	74637	5200,- 217,-	74682
madlo / klika L	Kč €	3710,- 155,-	74491	4050,- 169,-	74545	4050,- 169,-	053722	4460,- 186,-	097146	5200,- 217,-	74644	5200,- 217,-	74699
rozeta zaslepovací	Kč €	430,- 18,-	72381	520,- 22,-	72398	770,- 33,-	055337	840,- 35,-	101744	840,- 35,-	72411	840,- 35,-	72428

V balení je standardně montážní materiál pro tl. dveří 38 - 45 mm. Pro větší tloušťky dveří je potřeba specifikovat jiný montážní materiál viz. Příslušenství a komponenty str. 368.

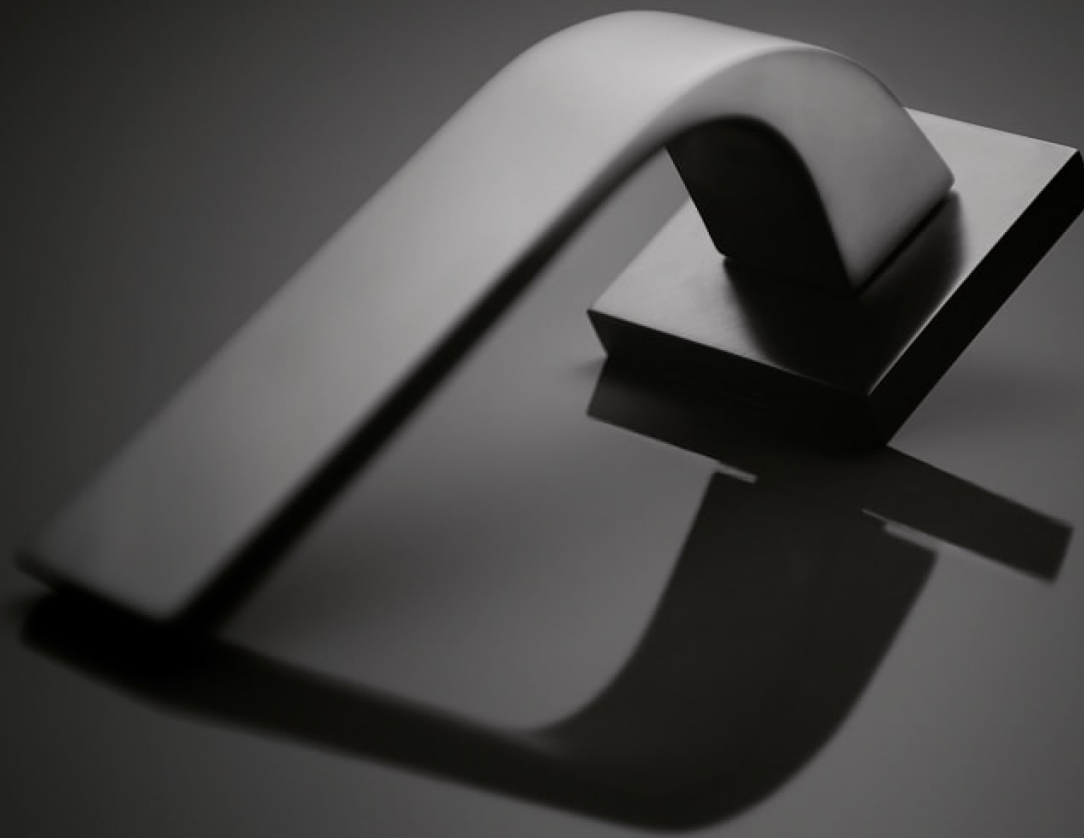

Celý projekt - jeden design

Dveřní kliky DESIGN 2006



Kování pro hliníkové a ocelové dveře, kování na branky

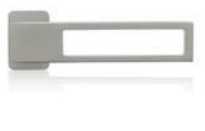

Kliky a zámky na skleněné dveře



Madla a koule na skleněné a dřevěné dveře



Panty na skleněné dveře



Bezpečnostní rozety



Mušle na posuvné dveře



Panty na dřevěné dveře



Okenní kliky 3 a 4 polohové



Bezpečnostní madla Entero



Madla dlouhá





Materiál: **masivní mosaz** 



Povrchy: **SNi, SNi - broušeno, Cr, TiN-C, TiN-K, Ms, Ms-L**  
více info na [www.kliky-mt.cz/manufaktura/barvy-povrchy](http://www.kliky-mt.cz/manufaktura/barvy-povrchy)



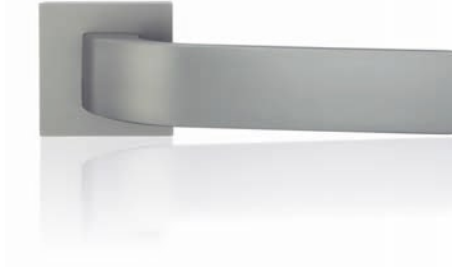

Kování představené v roce 2006 na mezinárodním veletrhu Practical World v Kolíně nad Rýnem se ihned stalo ikonou v tomto segmentu. Kliky řady DESIGN 2006 se vyznačují nezaměnitelným designem s citlivě vyváženou proporcí mezi klikou a rozetou. U této kolekce je poprvé použit systém tlačných pružin v zapouzdřené vnitřní konstrukci rozet, které vynikají svoji stabilitou při přenosu zatížení mezi klikou a zámkem a zároveň velmi tichým chodem. Nadčasovost klik M&T je zřejmá i na mnoha kopiích od mnoha výrobců z různých částí světa, které i po 15 letech od uvedení na trh neustále vznikají a zaplavují trh jako další novinky ©.

**ENTRY TiN-K** titan černý mat

**TRINITY TiN-C** titan chrom mat



-  Kliku/klika + rozety čtvercové
-  Madlo/klika R + rozety čtvercové
-  Madlo/klika L + rozety čtvercové

-  Rozety dozické
-  Rozety cylindrické
-  Rozety WC
-  Rozety zaslepovací



dozické    cylindrické    WC ex    WC in    zaslepovací    madlo Entry

rozety 54x54 mm

konstrukční varianty, materiálové provedení

- designová sada standardně bez spodních rozet
- spodní rozety se objednávají samostatně
- konstrukční systém 4 tlačných pružin u kliky
- velmi tichý chod
- montáž sešroubování pouzdrů proti sobě
- další fixace pomocí 4 vrtů
- rukojeti vyrobeny z masivní mosazi
- rozety vyrobeny z masivní mosazi
- zajišťovací gel proti uvolnění šroubů
- vrtání PROFI šablonou M&T vrtákem Ø 6,4 mm
- animace montáže na [www.kliky-mt.cz/montaze-kovani](http://www.kliky-mt.cz/montaze-kovani)
- montáž pro tloušťky dveří 38 – 126 mm
- v balení standardně montážní materiál pro tl. dveří 38 - 45 mm
- záruka 3 roky, titany 15 let, mosaz doživotní

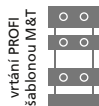

roky **3 garance**    let **15 garance**

Ochranná známka – registrovaná značka

**ENTERO®**

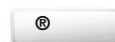

Chráněné průmyslové vzory klik



**ENTERO**  
**ENTRY**  
**TRINITY**  
**MY**  
**TERRY**





SNi matný nikel



TiN-C titan chrom mat



SNi matný nikel



TiN-K titan černý mat



SNi matný nikel



**Entry**

3810,- Kč  
159,- EUR

**Trinity**

3300,- Kč  
138,- EUR

**My**

3460,- Kč  
145,- EUR

**Terry**

3460,- Kč  
145,- EUR

**Entero**

3810,- Kč  
159,- EUR

**Rozety** 54x54 mm

990,- Kč  
42,- EUR

Kč	materiál: masivní mosaz povrch: SNi matný nikel	EUR
3810,-		159,-
4930,-		206,-
4930,-		206,-
3300,-		138,-
4440,-		185,-
4440,-		185,-
3460,-		145,-
4620,-		193,-
4620,-		193,-
3460,-		145,-
4620,-		193,-
4620,-		193,-
3810,-		159,-
4930,-		206,-
4930,-		206,-
990,-		42,-
990,-		42,-
1160,-		49,-
1980,-		83,-



		Sni		Sni - broušeno		Cr		Ms		TiN-C		TiN-K	
		cena	EAN	cena	EAN	cena	EAN	cena	EAN	cena	EAN	cena	EAN
		pár		pár		pár		pár		pár		pár	
klika / klika	Kč €	3810,- 159,-	91405	3910,- 163,-	78710	4130,- 173,-	78741	4130,- 173,-	053838	5100,- 213,-	78802	5100,- 213,-	78833
madlo / klika R	Kč €	4930,- 206,-	91412	5050,- 211,-	78727	5280,- 220,-	78758	5280,- 220,-	053845	6420,- 268,-	78819	6420,- 268,-	78857
madlo / klika L	Kč €	4930,- 206,-	91429	5050,- 211,-	78734	5280,- 220,-	78765	5280,- 220,-	053852	6420,- 268,-	78826	6420,- 268,-	78871
klika / klika	Kč €	3300,- 138,-	91436	3410,- 143,-	78895	3630,- 152,-	78925	3630,- 152,-	053890	4620,- 193,-	78987	4620,- 193,-	79014
madlo / klika R	Kč €	4440,- 185,-	91443	4570,- 191,-	78901	4800,- 200,-	78932	4800,- 200,-	053906	5770,- 241,-	78994	5770,- 241,-	79038
madlo / klika L	Kč €	4440,- 185,-	91450	4570,- 191,-	78918	4800,- 200,-	78949	4800,- 200,-	053913	5770,- 241,-	79007	5770,- 241,-	79052
klika / klika	Kč €	3460,- 145,-	91467	3590,- 150,-	79076	3810,- 159,-	79106	3810,- 159,-	053951	4800,- 200,-	79168	4800,- 200,-	79199
madlo / klika R	Kč €	4620,- 193,-	91474	4710,- 197,-	79083	4930,- 206,-	79113	4930,- 206,-	053968	5930,- 248,-	79175	5930,- 248,-	79212
madlo / klika L	Kč €	4620,- 193,-	91481	4710,- 197,-	79090	4930,- 206,-	79120	4930,- 206,-	053975	5930,- 248,-	79182	5930,- 248,-	79236
klika / klika	Kč €	3460,- 145,-	91498	3590,- 150,-	79250	3810,- 159,-	79281	3810,- 159,-	054019	4800,- 200,-	79342	4800,- 200,-	79373
madlo / klika R	Kč €	4620,- 193,-	91504	4710,- 197,-	79267	4930,- 206,-	79298	4930,- 206,-	054026	5930,- 248,-	79359	5930,- 248,-	79397
madlo / klika L	Kč €	4620,- 193,-	91511	4710,- 197,-	79274	4930,- 206,-	79304	4930,- 206,-	054033	5930,- 248,-	79366	5930,- 248,-	79410
klika / klika	Kč €	3810,- 159,-	91528	3910,- 163,-	90910	4130,- 173,-	91030	4130,- 173,-	054071	5100,- 213,-	90958	5100,- 213,-	90996
madlo / klika R	Kč €	4930,- 206,-	91535	5050,- 211,-	90927	5280,- 220,-	91047	5280,- 220,-	054088	6420,- 268,-	90965	6420,- 268,-	91009
madlo / klika L	Kč €	4930,- 206,-	91542	5050,- 211,-	90934	5280,- 220,-	91054	5280,- 220,-	054095	6420,- 268,-	90972	6420,- 268,-	91016
dozické	Kč €	990,- 42,-	91559	1050,- 44,-	79465	1160,- 49,-	79502	1160,- 49,-	054132	1490,- 63,-	79526	1490,- 63,-	79533
cyldrické	Kč €	990,- 42,-	91566	1050,- 44,-	79434	1160,- 49,-	79441	1160,- 49,-	054149	1490,- 63,-	68414	1490,- 63,-	79472
zaslepovací	Kč €	1160,- 49,-	91573	1210,- 51,-	83516	1330,- 56,-	83523	1330,- 56,-	054156	1650,- 69,-	83547	1650,- 69,-	83554
WC	Kč €	1980,- 83,-	91580	2050,- 86,-	79557	2160,- 90,-	79564	2160,- 90,-	054163	2470,- 103,-	79588	2470,- 103,-	79595

U kombinace madlo / klika dodáváme standardně madlo Entry pevné - neotočné.

V balení je standardně montážní materiál pro tl. dveří 38 - 45 mm. Pro větší tloušťky dveří je potřeba specifikovat jiný montážní materiál viz. Příslušenství a komponenty str. 368.



Klika Mimolimit



Celý projekt - jeden design

Dveřní kličky DESIGN 2009



Dveřní zarážky



Madla a koule na skleněné a dřevěné dveře



Panty na dřevěné dveře



Okenní kličky 3 a 4 polohové



Okenní kličky HS Portaly na posuvná okna a stěny



Madla dlouhá



Kličky a zámky na skleněné dveře



Panty na skleněné dveře



Mušle na posuvné dveře



Bezpečnostní rozety



Kování pro hliníkové a ocelové dveře, kování na branky





Dveřní kliky DESIGN 2009 **Toro, Maya, Tukan, Mimolimit**

Materiál: masivní mosaz 

Povrchy: **SNi, SNI - broušeno, Cr, TiN-C, TiN-K, TiN-B, Ms, Ms-L**  
více info na [www.kliky-mt.cz/manufaktura/barvy-povrchy](http://www.kliky-mt.cz/manufaktura/barvy-povrchy)

Kování uvedené na trh v roce 2009 představuje neustálou designovou a materiálovou inovaci ve společnosti M&T. Povrchy a materiály použité v této kolekci tj. povrch TiN-B titan braun mat, kombinace masivní dřeva + kov, použití materiálu Alu kompakt, jsou i nyní na úplném vrcholu současného designu. Řada kování Mimolimit s mnoha doplňky si opakovaně nachází svoje uplatnění v těch nejprestižnějších projektech na známých adresách v různých částech světa. Konstrukčně je využit systém tlačných pružin v zapouzdřené vnitřní konstrukci rozet, které vynikají svoji stabilitou při přenosu zatížení mezi klikou a zámkem a zároveň velmi tichým chodem.

**TORO TiN-B** titan braun mat

**MIMOLIMIT TiN-K** titan černý mat + dřevina masivní ořech

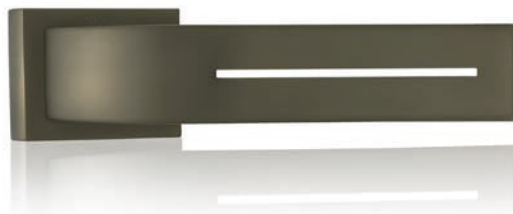

-  Klika/klika + rozety obdélníkové
-  Madlo/klika R + rozety obdélníkové
-  Madlo/klika L + rozety obdélníkové
-  Spodní rozety dozické
-  Spodní rozety cylindrické
-  Spodní rozety WC
-  Spodní rozety zaslepovací

-  Klika/klika + rozety čtvercové
-  Madlo/klika R + rozety čtvercové
-  Madlo/klika L + rozety čtvercové
-  Spodní rozety dozické
-  Spodní rozety cylindrické
-  Spodní rozety WC
-  Spodní rozety zaslepovací



dozické    cylindrické    WC ex Toro    WC in Toro    madlo Toro

rozety 60x47 mm



dozické    cylindrické    WC ex    WC in    madlo Mimolimit

rozety 54x54 mm

konstrukční varianty, materiálové provedení

- designová sada standardně bez spodních rozet
- spodní rozety 60x47 mm se objednávají samostatně
- u řady klik Mimolimit použity rozety 54x54 mm
- madla vždy v designu podle kliky z vnitřní strany dveří
- konstrukční systém 4 tlačných pružin u kliky
- velmi tichý chod
- montáž sešroubování pouzdrů proti sobě
- další fixace pomocí 4 vrtů
- rukojeti vyrobeny z masivní mosazi
- rozety vyrobeny z masivní mosazi
- vrtání PROFI šablonou M&T vrtákem Ø 6,4 mm
- animace montáže na [www.kliky-mt.cz/montaze-kovani](http://www.kliky-mt.cz/montaze-kovani)
- montáž pro tloušťky dveří 38 – 126 mm
- záruka 3 roky, titany 15 let, mosaz doživotní

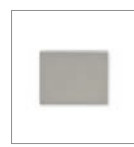
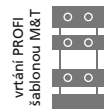

zaslepovací

Ochranná známka – registrovaná značka **MIMOLIMIT®**



Chráněné průmyslové vzory klik



**TORO  
MAYA  
TUKAN  
MIMOLIMIT**

madla **MIMOLIMIT**

roky **3 garance** let **15 garance**

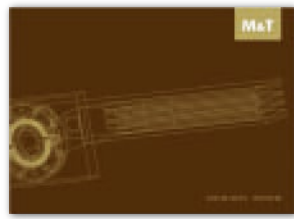



materiál: masivní mosaz  
Kč povrch: SNI matný nikl - broušeno EUR



TiN-B titan braun mat



SNI matný nikl

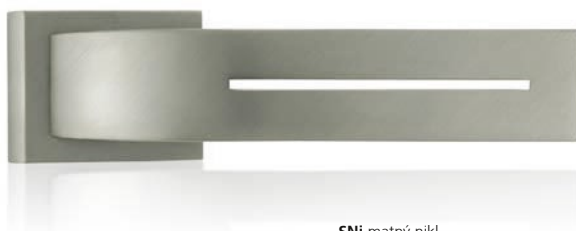

SNI matný nikl



**Tukan**

4130,- Kč  
173,- EUR

4130,- 173,-

5430,- 227,-

5430,- 227,-

**Maya**

4440,- Kč  
185,- EUR

4440,- 185,-

5770,- 241,-

5770,- 241,-

**Toro**

4130,- Kč  
173,- EUR

4130,- 173,-

5430,- 227,-

5430,- 227,-

**Rozety** 60x47 mm

990,- Kč  
42,- EUR

990,- 42,-

990,- 42,-

990,- 42,-

990,- 42,-

2160,- 90,-

2160,- 90,-

2160,- 90,-

2160,- 90,-

1330,- 56,-

1330,- 56,-



		SNI - broušeno		Cr		Ms		TiN-C		TiN-B	
		cena	EAN	cena	EAN	cena	EAN	cena	EAN	cena	EAN
		pár		pár		pár		pár		pár	
klika / klika	Kč €	4130,- 173,-	85213	4440,- 185,-	022032	4440,- 185,-	054217	5430,- 227,-	85268	5430,- 227,-	85312
madlo / klika R	Kč €	5430,- 227,-	85244	5770,- 241,-	022049	5770,- 241,-	054224	6920,- 289,-	85299	6920,- 289,-	85343
madlo / klika L	Kč €	5430,- 227,-	85251	5770,- 241,-	022056	5770,- 241,-	054231	6920,- 289,-	85305	6920,- 289,-	85350
klika / klika	Kč €	4440,- 185,-	85367	4800,- 200,-	022070	4800,- 200,-	054279	5770,- 241,-	85411	5770,- 241,-	85466
madlo / klika R	Kč €	5770,- 241,-	85398	6090,- 254,-	022087	6090,- 254,-	054286	7240,- 302,-	85442	7240,- 302,-	85497
madlo / klika L	Kč €	5770,- 241,-	85404	6090,- 254,-	022094	6090,- 254,-	054293	7240,- 302,-	85459	7240,- 302,-	85503
klika / klika	Kč €	4130,- 173,-	85510	4440,- 185,-	022117	4440,- 185,-	054330	5430,- 227,-	85565	5430,- 227,-	85619
madlo / klika R	Kč €	5430,- 227,-	85541	5770,- 241,-	022124	5770,- 241,-	054347	6920,- 289,-	85596	6920,- 289,-	85640
madlo / klika L	Kč €	5430,- 227,-	85558	5770,- 241,-	022131	5770,- 241,-	054354	6920,- 289,-	85602	6920,- 289,-	85657

		SNI - broušeno		Cr		Ms		TiN-C		TiN-B	
		cena	EAN	cena	EAN	cena	EAN	cena	EAN	cena	EAN
		pár		pár		pár		pár		pár	
dozické Maya	Kč €	990,- 42,-	85930	1160,- 49,-	022261	1160,- 49,-	054392	1490,- 63,-	85992	1490,- 63,-	86050
dozické Toro / Tukan	Kč €	990,- 42,-	86111	1160,- 49,-	022278	1160,- 49,-	054408	1490,- 63,-	86128	1490,- 63,-	86135
cyklindrické Maya	Kč €	990,- 42,-	85947	1160,- 49,-	022285	1160,- 49,-	054415	1490,- 63,-	86005	1490,- 63,-	86067
cyklindrické Toro / Tukan	Kč €	990,- 42,-	86142	1160,- 49,-	022292	1160,- 49,-	054422	1490,- 63,-	86159	1490,- 63,-	86166
WC Maya R	Kč €	2160,- 90,-	85954	2320,- 97,-	022308	2320,- 97,-	054439	2640,- 110,-	86012	2640,- 110,-	86074
WC Maya L	Kč €	2160,- 90,-	85961	2320,- 97,-	022315	2320,- 97,-	054446	2640,- 110,-	86029	2640,- 110,-	86081
WC Toro / Tukan R	Kč €	2160,- 90,-	85978	2320,- 97,-	022322	2320,- 97,-	054453	2640,- 110,-	86036	2640,- 110,-	86098
WC Toro / Tukan L	Kč €	2160,- 90,-	85985	2320,- 97,-	022339	2320,- 97,-	054460	2640,- 110,-	86043	2640,- 110,-	86104
zaslepovací Toro / Tukan	Kč €	1330,- 56,-	021998	1430,- 60,-	022001	1430,- 60,-	054477	1830,- 77,-	022018	1830,- 77,-	022025
zaslepovací Maya	Kč €	1330,- 56,-	020670	1430,- 60,-	020687	1430,- 60,-	054484	1830,- 77,-	020694	1830,- 77,-	020700

U kombinace madlo / klika dodáváme standardně madla pevná - neotočná.

V balení je standardně montážní materiál pro tl. dveří 39 - 45 mm. Pro jiné tloušťky dveří je potřeba specifikovat přesnou tloušťku dveří.



TiN-B titan braun mat + dub

**Mimolimit**

4030,- Kč  
168,- EUR



Alu kompakt



**Destičky Mimolimit**

1700,- Kč  
71,- EUR



SNI matný nikl + ořech

**Madlo Mimolimit**

4570,- Kč  
191,- EUR



SNI matný nikl + teak

**Madlo Mimolimit**

4740,- Kč  
198,- EUR

**Kč** materiál: masivní mosaz povrch: SNI matný nikl **EUR**

4030,- 168,-



5330,- 223,-



5330,- 223,-



**Kč** materiál: masivní dřevo povrch: olejováno **EUR**

1700,- 71,-

860,- 36,-

860,- 36,-

960,- 40,-

1040,- 44,-

860,- 36,-



**Kč** materiál: masivní mosaz povrch: SNI matný nikl broušeno **EUR**

4570,- 191,-

5460,- 228,-

8020,- 335,-

9070,- 378,-

11940,- 498,-

14990,- 625,-



**Kč** materiál: masivní mosaz povrch: SNI matný nikl broušeno **EUR**

4740,- 198,-



4910,- 205,-

5080,- 212,-

5080,- 212,-



		SNI		SNI - broušeno		Cr		Ms		TiN-C		TiN-K		TiN-B	
		cena	EAN	cena	EAN	cena	EAN	cena	EAN	cena	EAN	cena	EAN	cena	EAN
		pár		pár		pár		pár		pár		pár		pár	
klika / klika	Kč €	4030,- 168,-	087284	4130,- 173,-	85664	4440,- 185,-	022155	4440,- 185,-	054590	5430,- 227,-	85725	5430,- 227,-	85787	5430,- 227,-	85848
madlo / klika R	Kč €	5330,- 223,-	087291	5430,- 227,-	85695	5770,- 241,-	022162	5770,- 241,-	054606	6920,- 289,-	85756	6920,- 289,-	85817	6920,- 289,-	85879
madlo / klika L	Kč €	5330,- 223,-	087307	5430,- 227,-	85701	5770,- 241,-	022179	5770,- 241,-	054613	6920,- 289,-	85763	6920,- 289,-	85824	6920,- 289,-	85886

V balení je standardně montážní materiál pro tl. dveří 38 - 45 mm. Pro větší tloušťky dveří je potřeba specifikovat jiný montážní materiál viz. Příslušenství a komponenty str. 368.

		cena	EAN
		pár	
Alu kompak	Kč €	1700,- 71,-	83899
ořech	Kč €	860,- 36,-	83851
jilm	Kč €	860,- 36,-	83868
bělený dub	Kč €	960,- 40,-	83875
teak	Kč €	1040,- 44,-	83844
dub	Kč €	860,- 36,-	83882

zakázkově lze rukojeť dodat v dalších dřevinách



Rozety 54x54 mm		TiN-B	
		cena	EAN
		pár	
dozické	Kč €	1490,- 63,-	043099
cyklindrické	Kč €	1490,- 63,-	043105
zaslepovací	Kč €	1650,- 69,-	043112
WC	Kč €	2470,- 103,-	043129

ostatní povrchy rozet na str. 87

rozteč / celk. délka		SNI - broušeno		Cr		Ms		TiN-C		TiN-K		TiN-B	
		cena	EAN	cena	EAN	cena	EAN	cena	EAN	cena	EAN	cena	EAN
		ks		ks		ks		ks		ks		ks	
300 / 340 mm	Kč €	4570,- 191,-	83301	4710,- 197,-	022209	4710,- 197,-	058895	6690,- 279,-	83349	6690,- 279,-	83363	6690,- 279,-	83387
600 / 640 mm	Kč €	5460,- 228,-	83318	5610,- 234,-	022216	5610,- 234,-	058901	7590,- 317,-	83356	7590,- 317,-	83370	7590,- 317,-	83394
900 / 940 mm	Kč €	8020,- 335,-	83974	8170,- 341,-	022223	8170,- 341,-	058918	10470,- 437,-	84018	10470,- 437,-	84056	10470,- 437,-	84094
1200 / 1240 mm	Kč €	9070,- 378,-	83981	9240,- 385,-	022230	9240,- 385,-	058925	11200,- 467,-	84025	11200,- 467,-	84063	11200,- 467,-	84100
1800 / 1840 mm	Kč €	11940,- 498,-	83998	12120,- 505,-	022247	12120,- 505,-	058932	14910,- 622,-	84032	14910,- 622,-	84070	14910,- 622,-	84117
2400 / 2440 mm	Kč €	14990,- 625,-	84001	15140,- 631,-	022254	15140,- 631,-	058949	18600,- 775,-	84049	18600,- 775,-	84087	18600,- 775,-	84124

Uváděné ceny pouze za kovovou část madla. Kompletní ceny za dřevěnou část + montážní materiál jsou uvedeny na str. 220 - 221 Madla dlouhá.

		SNI - broušeno	
		cena / pár	EAN
tloušťka dveří 37 - 50 mm	Kč €	4740,- 198,-	32040
tloušťka dveří 51 - 68 mm	Kč €	4910,- 205,-	32057
tloušťka dveří 69 - 85 mm	Kč €	5080,- 212,-	32064
tloušťka dveří 8 - 12 mm sklo	Kč €	5080,- 212,-	32071

Další možnosti povrchů madel na str. 335.

Destičky k madlu 54x54 mm		cena	EAN
		ks	
Alu kompak	Kč €	530,- 23,-	101997
ořech	Kč €	450,- 19,-	102000
jilm	Kč €	450,- 19,-	102017
bělený dub	Kč €	450,- 19,-	101423
teak	Kč €	480,- 20,-	102024
dub	Kč €	450,- 19,-	102031







Celý projekt - jeden design

Dveřní kliky DESIGN 2011 řada MINI



Kliky a zámky na skleněné dveře



Bezpečnostní rozety



Panty na skleněné dveře



Panty na dřevěné dveře



Mušle na posuvné dveře



Okenní kliky 3 a 4 polohové





Dveřní kliky DESIGN 2011 **Mini-V, Mini-C, Mini-S, Mini-T**

Materiál: **masivní mosaz** 

Povrchy: **SNi, Cr, TiN-K, Ms, Ms-L**  
více info na [www.kliky-mt.cz/manufaktura/barvy-povrchy](http://www.kliky-mt.cz/manufaktura/barvy-povrchy)





Kování uvedené na trh v roce 2011 reaguje na požadavky zákazníků s oblibou v minimalistickém pojetí interiérů, kdy díky nové konstrukci mini rozet dochází k minimalizaci celého vzhledu této řady dveřních klik. Budete překvapeni perfektní funkcí mini rozet a celého kování řady MINI.



ROMAN  
ULICH

**MINI-V SNi** matný nikl



-  Klikla/klika + rozety mini
-  Rozety mini dozické
-  Rozety mini WC
-  Rozety mini zaslepovací



dozické zaslepovací WC in WC ex

rozety 47x33 mm

**MINI-T TiN-K** titan černý mat



-  Klikla/klika + rozety čtvercové
-  Madlo/klika R + rozety čtvercové
-  Madlo/klika L + rozety čtvercové
-  Rozety čtvercové dozické
-  Rozety čtvercové cylindrické
-  Rozety čtvercové WC
-  Rozety čtvercové zaslepovací



dozické cylindrické WC in WC ex zaslepovací

rozety 47x47 mm

konstrukční varianty, materiálové provedení

- designová sada standardně bez spodních rozet
- spodní rozety se objednávají samostatně
- 2 varianty rozet tj. mini, nebo čtvercové 47x47 mm
- konstrukční systém 4 tlačných pružin u kliky
- velmi tichý chod
- montáž sešroubování pouzdry proti sobě
- další fixace pomocí 8 vrtutů
- rukojeti vyrobeny z masivní mosazi
- rozety vyrobeny z masivní mosazi
- vrtání PROFI šablonou M&T vrtákem Ø 6,4 mm
- animace montáže na [www.kliky-mt.cz/montaze-kovani](http://www.kliky-mt.cz/montaze-kovani)
- montáž pro tloušťky dveří 38 – 126 mm
- možnost dodání v protipožárním provedení
- v balení standardně montážní materiál pro tl. dveří 38 - 45 mm
- záruka 3 roky, titany 15 let, mosaz natural doživotní

vrtání PROFI  
šablonou M&T

roky **3 garance** let **15 garance**

Ochranná známka – registrovaná značka

**MINI®**

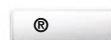

madlo Minimal

Chráněné průmyslové vzory klik



**MINI-V**  
**MINI-C**  
**MINI-S**  
**MINI-T**





SNi matný nikl

**Mini-V**

2320,- Kč  
97,- EUR



**Mini-C**

2160,- Kč  
90,- EUR



TiN-K titan černý mat

**Mini-S**

2160,- Kč  
90,- EUR



**Mini-T**

2160,- Kč  
90,- EUR



**Rozety Mini**

660,- Kč  
28,- EUR



**Rozety čtvercové 47x47 mm**

1160,- Kč  
49,- EUR



materiál: masivní mosaz  
povrch: SNi matný nikl

**Kč** **EUR**

2320,- 97,-

2960,- 124,-

3300,- 138,-

3300,- 138,-

2160,- 90,-

2810,- 118,-

3140,- 131,-

3140,- 131,-

2160,- 90,-

2810,- 118,-

3140,- 131,-

3140,- 131,-

2160,- 90,-

2810,- 118,-

3140,- 131,-

3140,- 131,-

660,- 28,-

840,- 35,-

1490,- 63,-

1160,- 49,-

1160,- 49,-

1330,- 56,-

1830,- 77,-

		SNI		Cr		Ms		TiN-K	
		cena pár	EAN	cena pár	EAN	cena pár	EAN	cena pár	EAN
klika / klika	Kč €	2320,- 97,-	86241	2640,- 110,-	86296	2640,- 110,-	054651	3630,- 152,-	86340
klika / klika na rozetách 47x47 mm	Kč €	2960,- 124,-	86258	3300,- 138,-	86302	3300,- 138,-	054668	4300,- 180,-	86357
madlo / klika L na rozetách 47x47 mm	Kč €	3300,- 138,-	86265	3630,- 152,-	86319	3630,- 152,-	054675	4620,- 193,-	86364
madlo / klika R na rozetách 47x47 mm	Kč €	3300,- 138,-	86272	3630,- 152,-	86326	3630,- 152,-	054682	4620,- 193,-	86371
klika / klika	Kč €	2160,- 90,-	86395	2470,- 103,-	86449	2470,- 103,-	054736	3460,- 145,-	86494
klika / klika na rozetách 47x47 mm	Kč €	2810,- 118,-	86401	3140,- 131,-	86456	3140,- 131,-	054743	4130,- 173,-	86500
madlo / klika L na rozetách 47x47 mm	Kč €	3140,- 131,-	86418	3460,- 145,-	86463	3460,- 145,-	054750	4440,- 185,-	86517
madlo / klika R na rozetách 47x47 mm	Kč €	3140,- 131,-	86425	3460,- 145,-	86470	3460,- 145,-	054767	4440,- 185,-	86524
klika / klika	Kč €	2160,- 90,-	86548	2470,- 103,-	86593	2470,- 103,-	054811	3460,- 145,-	86647
klika / klika na rozetách 47x47 mm	Kč €	2810,- 118,-	86555	3140,- 131,-	86609	3140,- 131,-	054828	4130,- 173,-	86654
madlo / klika L na rozetách 47x47 mm	Kč €	3140,- 131,-	86562	3460,- 145,-	86616	3460,- 145,-	054835	4440,- 185,-	86661
madlo / klika R na rozetách 47x47 mm	Kč €	3140,- 131,-	86579	3460,- 145,-	86623	3460,- 145,-	054842	4440,- 185,-	86678
klika / klika	Kč €	2160,- 90,-	86692	2470,- 103,-	86746	2470,- 103,-	054897	3460,- 145,-	86791
klika / klika na rozetách 47x47 mm	Kč €	2810,- 118,-	86708	3140,- 131,-	86753	3140,- 131,-	054903	4130,- 173,-	86807
madlo / klika L na rozetách 47x47 mm	Kč €	3140,- 131,-	86715	3460,- 145,-	86760	3460,- 145,-	054910	4440,- 185,-	86814
madlo / klika R na rozetách 47x47 mm	Kč €	3140,- 131,-	86722	3460,- 145,-	86777	3460,- 145,-	054927	4440,- 185,-	86821
dozické	Kč €	660,- 28,-	86845	840,- 35,-	86869	840,- 35,-	054972	1160,- 49,-	86883
zaslepovací	Kč €	840,- 35,-	021936	990,- 42,-	021943	990,- 42,-	054989	1330,- 56,-	021950
WC	Kč €	1490,- 63,-	86852	1750,- 73,-	86876	1750,- 73,-	054996	2320,- 97,-	86890
dozické	Kč €	1160,- 49,-	86906	1270,- 53,-	86937	1270,- 53,-	055030	1490,- 63,-	86968
cylindrické	Kč €	1160,- 49,-	86913	1270,- 53,-	86944	1270,- 53,-	055047	1490,- 63,-	86975
zaslepovací	Kč €	1330,- 56,-	86920	1430,- 60,-	86951	1430,- 60,-	055054	1650,- 69,-	86982
WC	Kč €	1830,- 77,-	021967	1980,- 83,-	021974	1980,- 83,-	055061	2320,- 97,-	021981

U kombinace madlo / klika dodáváme standardně madlo Minimal pevné - neotočné.

V balení je standardně montážní materiál pro tl. dveří 38 - 45 mm. Pro větší tloušťky dveří je potřeba specifikovat jiný montážní materiál viz. Příslušenství a komponenty str. 368.



reddot design award  
winner 2013

mezinárodní prestižní ocenění za design



Celý projekt - jeden design

Dveřní kliky a kování DESIGN 2013  
řada MINIMAL/MAXIMAL



Kování pro hliníkové a ocelové dveře,  
kování na branky



Kliky a zámky na skleněné dveře



Panty na skleněné dveře



Bezpečnostní rozety



Dveřní zarážky



Okenní kliky  
3 a 4 polohové



Mušle na posuvné  
dveře



Okenní kliky HS Portaly  
na posuvná okna a stěny



Madla dlouhá



## Dveřní kliky DESIGN 2013 řada MINIMAL/MAXIMAL

Materiál: masivní mosaz 

Povrchy: **SNi, Cr, SNi-broušeno, TiN-C, TiN-B, TiN-K, Ms, Ms-L, Ms-A, TiN-A, Cr-K**  
více info na [www.kliky-mt.cz/manufaktura/barvy-povrchy](http://www.kliky-mt.cz/manufaktura/barvy-povrchy)

Kování uvedené na trh v roce 2013 se ihned stalo bestsellerem napříč veškerým kovááním dostupným na středoevropském trhu. Vrcholná nabídka kování Minimal /Maximal, která co do komplexnosti celé řady nemá v klikařském světě obdoby, je jasnou volbou všech, kteří vědí, že na detailu záleží a vyžadují ten největší možný komfort a designovou jednotnost svého projektu. Pro svůj inovativní design a komplexnost výrobní řady s jasným cílem: Celý projekt - jeden design, získalo kování Minimal / Maximal prestižní mezinárodní cenu za design RED DOT Design Award winner 2013. Toto ocenění získala naše společnost jako první v historii ČR a jako jedna z mála v celosvětovém měřítku v segmentu dveřního a okenního kování. Kování řady Maximal je připraveno pro kombinace s vkládanou výplní v nepřeberném množství barevných a materiálových variant.

**MINIMAL TiN-B** titan braun mat

**MAXIMAL Cr** lesklý chrom + výplň sklo - bílá glanz



Klika/klika



Rozety dozické



Rozety WC



Rozety zaslepovací 47x33 mm



Rozety double WC in



Madlo/klika R na rozetách 47x33 mm



Madlo/klika L na rozetách 47x33 mm



Rozety cylindrické čtvercové 47x47 mm



Rozety zaslepovací čtvercové 47x47 mm



dozické



WC in



WC ex



zaslepovací



madlo Minimal

rozety 47x33 mm



cylindrické



zaslepovací

rozety 47x47 mm

konstrukční varianty, materiálové provedení

- designová sada standardně bez spodních rozet
- spodní rozety se objednávají samostatně
- konstrukční systém 4 tlačných pružin u kliky
- velmi tichý chod celého systému
- montáž sešroubování pouzdry proti sobě
- další pomocná fixace s 8 vruty
- samostatná fixace rozety červíky 2x M4 s možností jemného nastavení polohy rozety/kliky
- rukojeti vyrobeny z masivní mosazi
- rozety vyrobeny z masivní mosazi
- zajišťovací gel proti uvolnění šroubů
- vrtání PROFÍ šablonou M&T vrtákem Ø 6,4 mm
- animace montáže na [www.kliky-mt.cz/montaze-kovani](http://www.kliky-mt.cz/montaze-kovani)
- montáž pro tloušťky dveří 38 – 126 mm
- možnost dodání v protipožárním provedení
- v balení standardně montážní materiál pro tl. dveří 38 - 45 mm
- čtvercové rozety 47x47 mm pro cylindrickou, nebo zaslepovací variantu
- záruka 3 roky, titany 15 let

vrtání PROFÍ  
šablonou M&T



Ochranné známky – registrované značky **MINIMAL®**  
**MAXIMAL®**



Chráněné průmyslové vzory klik

Celou řadu kování **Minimal / Maximal** chrání celkem 26 průmyslových vzorů zaregistrovaných po celém území EU, dokládající jejich původ a originalitu a zabráňující uvádění plagiátů na trh.



Patenty

- konstrukce a systém tlačných pružin u mušle pro posuvné dveře
- WC mechanismus se systémem stabilizace – 4 polohy / 90° s mechanickou dětskou pojistkou
- konstrukce ovládání kliky se systémem tlačných pružin, s velmi tichým chodem a trojitou stabilizací kliky

roky

**3 garance**

let

**15 garance**





MINIMAL Cr lesklý chrom

**Dveřní klika Minimal**

3920,- Kč  
164,- EUR

Kč	materiál: masivní mosaz povrch: SNI matný nikel	EUR
3920,-		164,-
4580,-		191,-
4580,-		191,-

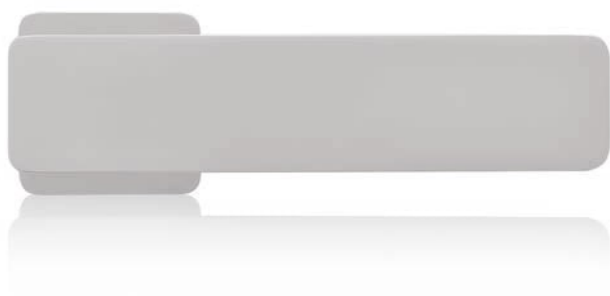

**Klika Minimal**  
na rozetách 47 x 47 mm

4230,- Kč  
177,- EUR

Kč	materiál: masivní mosaz povrch: SNI matný nikel	EUR
4230,-		177,-
4900,-		205,-
4900,-		205,-



MINIMAL TiN-C titan chrom mat



MINIMAL TiN-K titan černý mat



MINIMAL SNI matný nikel

**Rozety**

840,- Kč  
35,- EUR

Kč	materiál: masivní mosaz povrch: SNI matný nikel	EUR
840,-		35,-
990,-		42,-
1160,-		49,-
1160,-		49,-
1330,-		56,-
1650,-		69,-
1650,-		69,-
1980,-		83,-
1980,-		83,-
1980,-		83,-
1980,-		83,-

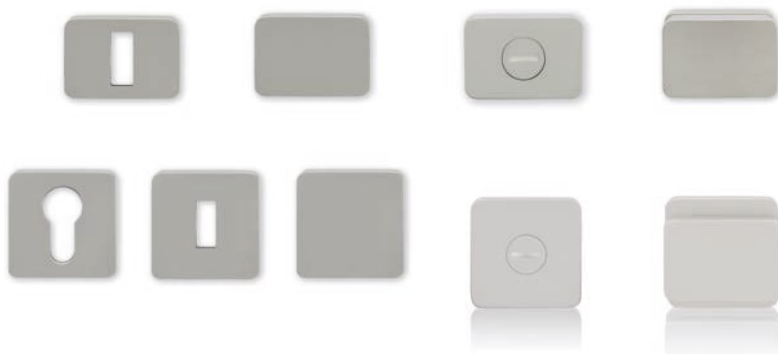

Povrchy TiN-A, Ms-L – více na [www.kliky-mt.cz/katalog](http://www.kliky-mt.cz/katalog)  
Protipožární provedení (kovové podrozety + nerezové spojovací prvky, čtyřhran) ... příplatek 520,- Kč ... EAN 082289  
Minimal Objekt (kovové podrozety s mechanikou v 6-ti jstících bodech) ... příplatek 340,- Kč ... EAN 082272  
Panikové provedení = Minimal Objekt + doobjednání správného děleného čtyřhranu na str. 369.



	SNI		SNI - broušeno		Cr		Ms		TiN-C		TiN-B		TiN-K		
	cena	EAN	cena	EAN	cena	EAN	cena	EAN	cena	EAN	cena	EAN	cena	EAN	
	pár		pár		pár		pár		pár		pár		pár		
klika / klika	Kč €	3920,- 164,-	000009	4030,- 168,-	000016	4230,- 177,-	000023	4230,- 177,-	055115	5230,- 218,-	000030	5230,- 218,-	000047	5230,- 218,-	000054
madlo / klika R	Kč €	4580,- 191,-	000078	4670,- 195,-	000085	4900,- 205,-	000092	4900,- 205,-	055122	6060,- 253,-	000108	6060,- 253,-	000115	6060,- 253,-	000122
madlo / klika L	Kč €	4580,- 191,-	000146	4670,- 195,-	000153	4900,- 205,-	000160	4900,- 205,-	055139	6060,- 253,-	000177	6060,- 253,-	000184	6060,- 253,-	000191

U kombinace madlo / klika dodáváme standardně madlo Minimal pevné - neotočné.

V balení je standardně montážní materiál pro tl. dveří 38 - 45 mm. Pro větší tloušťky dveří je potřeba specifikovat jiný montážní materiál viz. Příslušenství a komponenty str. 368.

	SNI		SNI - broušeno		Cr		Ms		TiN-C		TiN-B		TiN-K		
	cena	EAN	cena	EAN	cena	EAN	cena	EAN	cena	EAN	cena	EAN	cena	EAN	
	pár		pár		pár		pár		pár		pár		pár		
klika / klika	Kč €	4230,- 177,-	065138	4350,- 182,-	065169	4580,- 191,-	065190	4580,- 191,-	065343	5570,- 233,-	065220	5570,- 233,-	065251	5570,- 233,-	065282
madlo / klika R	Kč €	4900,- 205,-	065145	5000,- 209,-	065176	5230,- 218,-	065206	5230,- 218,-	065350	6390,- 267,-	065237	6390,- 267,-	065268	6390,- 267,-	065299
madlo / klika L	Kč €	4900,- 205,-	065152	5000,- 209,-	065183	5230,- 218,-	065213	5230,- 218,-	065367	6390,- 267,-	065244	6390,- 267,-	065275	6390,- 267,-	065305



MINIMAL TiN-B titan braun mat



MINIMAL Ms natural mosaz



	SNI		SNI - broušeno		Cr		Ms		TiN-C		TiN-B		TiN-K		
	cena	EAN	cena	EAN	cena	EAN	cena	EAN	cena	EAN	cena	EAN	cena	EAN	
	pár		pár		pár		pár		pár		pár		pár		
dozické	Kč €	840,- 35,-	000467	880,- 37,-	000474	990,- 42,-	000481	990,- 42,-	055177	1160,- 49,-	000498	1160,- 49,-	000504	1160,- 49,-	000511
zaslepovací	Kč €	990,- 42,-	022353	1060,- 45,-	022360	1160,- 49,-	022377	1160,- 49,-	060799	1330,- 56,-	022384	1330,- 56,-	022391	1330,- 56,-	022407
cylinrické 47x47	Kč €	1160,- 49,-	000535	1220,- 51,-	000542	1330,- 56,-	000559	1330,- 56,-	055191	1490,- 63,-	000566	1490,- 63,-	000573	1490,- 63,-	000580
dozické 47x47	Kč €	1160,- 49,-	068429	1220,- 51,-	068436	1330,- 56,-	068443	1330,- 56,-	068450	1490,- 63,-	068467	1490,- 63,-	068474	1490,- 63,-	068481
zaslepovací 47x47	Kč €	1330,- 56,-	022421	1380,- 58,-	022438	1490,- 63,-	022445	1490,- 63,-	055207	1650,- 69,-	022452	1650,- 69,-	022469	1650,- 69,-	022476
WC Minimal	Kč €	1650,- 69,-	000603	1750,- 73,-	000610	1830,- 77,-	000627	1830,- 77,-	055214	2640,- 110,-	000634	2640,- 110,-	000641	2640,- 110,-	000658
WC Maximal	Kč €	1650,- 69,-	000672	1750,- 73,-	000689	1830,- 77,-	000696	1830,- 77,-	055221	2810,- 118,-	000702	2810,- 118,-	000719	2810,- 118,-	000726
WC Minimal double	Kč €	1980,- 83,-	022612	2080,- 87,-	022629	2160,- 90,-	022636	2160,- 90,-	055238	2960,- 124,-	022643	2960,- 124,-	022650	2960,- 124,-	022667
WC Maximal double	Kč €	1980,- 83,-	022681	2080,- 87,-	022698	2160,- 90,-	022704	2160,- 90,-	055245	3140,- 131,-	022711	3140,- 131,-	022728	3140,- 131,-	022735
WC Minimal na rozetách 47x47 *)	Kč €	1980,- 83,-	066685	2080,- 87,-	066692	2160,- 90,-	066708	2160,- 90,-	066715	2960,- 124,-	066722	2960,- 124,-	066739	2960,- 124,-	066746
WC Maximal na rozetách 47x47 *)	Kč €	1980,- 83,-	066753	2080,- 87,-	066760	2160,- 90,-	066777	2160,- 90,-	066784	3140,- 131,-	066791	3140,- 131,-	066807	3140,- 131,-	066814

\*) WC mechanismus nemá systém stabilizace po 90°.



**MAXIMAL SNi** - broušeno matný nikl - broušeno  
výplň dřevo - dýha 3D dub

**Dveřní klika Maximal**

4350,- Kč  
182,- EUR

materiál: masivní mosaz  
povrch: SNi matný nikl

Kč		EUR
4350,-		182,-
5000,-		209,-
5000,-		209,-

**Klika Maximal**  
na rozetách 47 x 47 mm

4670,- Kč  
195,- EUR

materiál: masivní mosaz  
povrch: SNi matný nikl

Kč		EUR
4670,-		195,-
5330,-		223,-
5330,-		223,-



**MAXIMAL Cr** lesklý chrom  
výplň efekt „sklo“ - bílá glanz

**Výplň kliky Maximal**

220,- Kč  
9,2 EUR



**MAXIMAL WC SNi** matný nikl  
výplň kůže - hnědá čokoládová

**Výplň WC Maximal**

160,- Kč  
6,7 EUR



**SNi** matný nikl

**Madlo Minimal**  
s funkcí kliky

4730,- Kč  
198,- EUR

materiál: masivní mosaz  
povrch: SNi matný nikl

Kč		EUR
4730,-		198,-
5390,-		225,-
5390,-		225,-





	Sni		Sni - broušeno		Cr		Ms		TiN-C		TiN-B		TiN-K		
	cena	EAN	cena	EAN	cena	EAN	cena	EAN	cena	EAN	cena	EAN	cena	EAN	
	pár		pár		pár		pár		pár		pár		pár		
klika / klika	Kč €	4350,- 182,-	000214	4440,- 185,-	000221	4670,- 195,-	000238	4670,- 195,-	062632	5640,- 235,-	000245	5640,- 235,-	000252	5640,- 235,-	000269
madlo / klika R	Kč €	5000,- 209,-	000283	5100,- 213,-	000290	5330,- 223,-	000306	5330,- 223,-	062649	6310,- 263,-	000313	6310,- 263,-	000320	6310,- 263,-	000337
madlo / klika L	Kč €	5000,- 209,-	000351	5100,- 213,-	000368	5330,- 223,-	000375	5330,- 223,-	062656	6310,- 263,-	000382	6310,- 263,-	000399	6310,- 263,-	000405

U kombinace madlo / klika dodáváme standardně madlo Minimal pevné - neotočné.

V balení je standardně montážní materiál pro tl. dveří 38 - 45 mm. Pro větší tloušťky dveří je potřeba specifikovat jiný montážní materiál viz. Příslušenství a komponenty str. 368.

	Sni		Sni - broušeno		Cr		Ms		TiN-C		TiN-B		TiN-K		
	cena	EAN	cena	EAN	cena	EAN	cena	EAN	cena	EAN	cena	EAN	cena	EAN	
	pár		pár		pár		pár		pár		pár		pár		
klika / klika	Kč €	4670,- 195,-	065404	4800,- 200,-	065435	5000,- 209,-	065466	5000,- 209,-	065619	5980,- 250,-	065497	5980,- 250,-	065527	5980,- 250,-	065558
madlo / klika R	Kč €	5330,- 223,-	065411	5430,- 227,-	065442	5640,- 235,-	065473	5640,- 235,-	065626	6650,- 278,-	065503	6650,- 278,-	065534	6650,- 278,-	065565
madlo / klika L	Kč €	5330,- 223,-	065428	5430,- 227,-	065459	5640,- 235,-	065480	5640,- 235,-	065633	6650,- 278,-	065510	6650,- 278,-	065541	6650,- 278,-	065572

	cena	EAN	
	ks		
dřevo	Kč €	220,- 9,2	000429
kov	Kč €	220,- 9,2	000436
kůže	Kč €	320,- 14,-	000443
„sklo“	Kč €	320,- 14,-	000450
RAL barvy	Kč €	320,- 14,-	022346

Samostatné komponenty výplně:  
vyměnitelná deska plast ... 84,- Kč / ks EAN 080544  
3M oboustranná nálepka ... 28,- Kč / ks EAN 080551



MAXIMAL Sni matný nikl  
výplň dřevo - dýha wenge

	cena	EAN	
	ks		
dřevo	Kč €	160,- 6,7	000740
kov	Kč €	160,- 6,7	000757
kůže	Kč €	220,- 9,2	000764
„sklo“	Kč €	220,- 9,2	000771
RAL barvy	Kč €	220,- 9,2	022490



MAXIMAL TiN-K titan černý mat  
výplň kov - šedá perlet



	Sni		Sni - broušeno		Cr		Ms		TiN-C		TiN-B		TiN-K		
	cena	EAN	cena	EAN	cena	EAN	cena	EAN	cena	EAN	cena	EAN	cena	EAN	
	pár		pár		pár		pár		pár		pár		pár		
klika / klika	Kč €	4730,- 198,-	065688	4840,- 202,-	065718	5070,- 212,-	065749	5070,- 212,-	065893	6060,- 253,-	065770	6060,- 253,-	065800	6060,- 253,-	065831
madlo / klika R	Kč €	5390,- 225,-	065695	5500,- 230,-	065725	5720,- 239,-	065756	5720,- 239,-	065909	6870,- 287,-	065787	6870,- 287,-	065817	6870,- 287,-	065848
madlo / klika L	Kč €	5390,- 225,-	065701	5500,- 230,-	065732	5720,- 239,-	065763	5720,- 239,-	065916	6870,- 287,-	065794	6870,- 287,-	065824	6870,- 287,-	065855



MINIMAL SNI  
matný nikl



**Mušle Minimal**

6110,- Kč  
255,- EUR



MAXIMAL SNI matný nikl  
výplň dřevo - dýha teak

**Mušle Maximal**

6110,- Kč  
255,- EUR

**Výplň mušle  
Maximal**

320,- Kč  
14,- EUR

materiál: masivní mosaz  
povrch: SNI matný nikl

**Kč** **EUR**

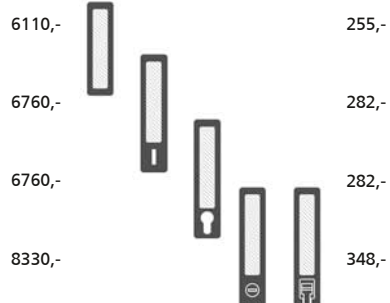
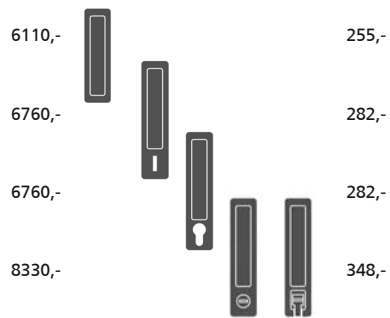

MINIMAL II



MAXIMAL II



**Mušle Minimal / Maximal II**

**Dveřní zarážka**

**Minimal**

760,-  32,-

**Maximal**

830,-  35,-

830,- Kč  
35,- EUR



MINIMAL SNI matný nikl



MAXIMAL SNI matný nikl  
výplň dřevo teak

**Výplň zarážky  
Maximal**

95,- Kč  
4,- EUR

materiál: masivní mosaz  
povrch: SNI matný nikl

**Kč** **EUR**





	SNI		SNI - broušeno		Cr		Ms		TiN-C		TiN-B		TiN-K		
	cena	EAN	cena	EAN	cena	EAN	cena	EAN	cena	EAN	cena	EAN	cena	EAN	
	Kč		Kč		Kč		Kč		Kč		Kč		Kč		
standard	€	6110,- 255,-	001211	6310,- 263,-	001228	6420,- 268,-	001235	6420,- 268,-	060836	7840,- 327,-	001242	7840,- 327,-	001259	7840,- 327,-	001266
dozická	€	6760,- 282,-	001280	6960,- 290,-	001297	7060,- 295,-	001303	7060,- 295,-	060843	8530,- 356,-	001310	8530,- 356,-	001327	8530,- 356,-	001334
cylindrická	€	6760,- 282,-	001358	6960,- 290,-	001365	7060,- 295,-	001372	7060,- 295,-	060850	8530,- 356,-	001389	8530,- 356,-	001396	8530,- 356,-	001402
WC / koupelna	€	8330,- 348,-	001426	8560,- 357,-	001433	8750,- 365,-	001440	8750,- 365,-	060867	10260,- 428,-	001457	10260,- 428,-	001464	10260,- 428,-	001471

standard	€	6110,- 255,-	001495	6310,- 263,-	001501	6420,- 268,-	001518	6420,- 268,-	060911	7840,- 327,-	001525	7840,- 327,-	001532	7840,- 327,-	001549
dozická	€	6760,- 282,-	001563	6960,- 290,-	001570	7060,- 295,-	001587	7060,- 295,-	060928	8530,- 356,-	001594	8530,- 356,-	001600	8530,- 356,-	001617
cylindrická	€	6760,- 282,-	001631	6960,- 290,-	001648	7060,- 295,-	001655	7060,- 295,-	060935	8530,- 356,-	001662	8530,- 356,-	001679	8530,- 356,-	001686
WC / koupelna	€	8330,- 348,-	001709	8560,- 357,-	001716	8750,- 365,-	001723	8750,- 365,-	060942	10260,- 428,-	001730	10260,- 428,-	001747	10260,- 428,-	001754

	cena	EAN	
	Kč		
dřevo	€	320,- 14,-	001778
kov	€	320,- 14,-	001785
kůže	€	430,- 18,-	001792
„sklo“	€	430,- 18,-	001808
RAL barvy	€	470,- 20,-	022506

více informací na str. 302 - 303 Mušle na posuvné dveře  
Výplně k mušlím Maximal i Maximal II se objednávají pod stejným EAN.

	SNI		Cr		TiN-K		
	cena	EAN	cena	EAN	cena	EAN	
	Kč		Kč		Kč		
Minimal II standard	€	990,- 42,-	101751	1280,- 54,-	101768	1710,- 72,-	101775
Maximal II standard	€	990,- 42,-	101874	1280,- 54,-	101881	1710,- 72,-	101898

Příprava / frézování do dveří je stejné pro všechny mušle  
v provedení standard.

	SNI		SNI - broušeno		Cr		Ms		TiN-C		TiN-B		TiN-K		
	cena	EAN	cena	EAN	cena	EAN	cena	EAN	cena	EAN	cena	EAN	cena	EAN	
	Kč		Kč		Kč		Kč		Kč		Kč		Kč		
Minimal	€	760,- 32,-	003277	830,- 35,-	003284	840,- 35,-	003291	840,- 35,-	062588	980,- 41,-	003307	1150,- 48,-	003314	1150,- 48,-	003321
Maximal	€	830,- 35,-	003345	880,- 37,-	003352	920,- 39,-	003369	920,- 39,-	062601	1060,- 45,-	003376	1220,- 51,-	003383	1220,- 51,-	003390

	cena	EAN	
	Kč		
dřevo	€	95,- 4,-	003413
kov	€	95,- 4,-	003420
kůže	€	140,- 5,9	003437
„sklo“	€	140,- 5,9	003444
RAL barvy	€	160,- 6,7	022537



více informací na str. 364 - 365 Dveřní zarážky



MINIMAL Cr lesklý chrom



MAXIMAL TIN-B titan braun mat  
výplň dřevo - dýha 3D dub

**Zámek na sklo**

**Minimal**

7080,-



295,-

8200,-



342,-

**Maximal**

7580,-



316,-

7580,- Kč

316,- EUR

**Výplň zámku na sklo**

**Maximal**

470,- Kč

20,- EUR



**Protikus na sklo**

7080,- Kč

295,- EUR

**Výplň protikusu na sklo**

**Maximal**

470,- Kč

20,- EUR



MINIMAL SNI matný nikl



MINIMAL TIN-K titan černý mat



MAXIMAL Cr lesklý chrom  
výplň efekt „sklo“ - bílá glanz

**Mušle na sklo**

**Minimal**

5260,-



220,-

**Maximal**

5260,-



220,-

5260,- Kč

220,- EUR



MINIMAL Cr lesklý chrom



MINIMAL zapuštěná  
SNI matný nikl



MAXIMAL zapuštěná  
SNI matný nikl + výplň dýha teak

**Okenní klika**

**Minimal**

2730,-



114,-

**Minimal zapuštěná**

2960,-



124,-

**Maximal**

3060,-



128,-

**Maximal zapuštěná**

3300,-



138,-

materiál: masivní mosaz  
povrch: SNI matný nikl

Kč

EUR

materiál: masivní mosaz  
povrch: SNI matný nikl

Kč

EUR

materiál: masivní mosaz  
povrch: SNI matný nikl

Kč

EUR

materiál: masivní mosaz  
povrch: SNI matný nikl

Kč

EUR



	SNI		SNI - broušeno		Cr		Ms		TiN-C		TiN-B		TiN-K		
	cena	EAN	cena	EAN	cena	EAN	cena	EAN	cena	EAN	cena	EAN	cena	EAN	
	pár		pár		pár		pár		pár		pár		pár		
Minimal standard	Kč €	7080,- 295,-	000788	7240,- 302,-	000795	7420,- 310,-	000801	7420,- 310,-	061413	8300,- 346,-	000818	8300,- 346,-	000825	8300,- 346,-	000832
Minimal WC	Kč €	8200,- 342,-	080797	8380,- 350,-	080803	8550,- 357,-	080810	8550,- 357,-	080827	9440,- 394,-	080841	9440,- 394,-	080865	9440,- 394,-	080858
Maximal standard	Kč €	7580,- 316,-	000856	7760,- 324,-	000863	7940,- 331,-	000870	7940,- 331,-	061420	8780,- 366,-	000887	8780,- 366,-	000894	8780,- 366,-	000900

	cena	EAN		cena	EAN		
	pár			pár			
dřevo	Kč €	470,- 20,-	000924	kůže	Kč €	560,- 24,-	000948
kov	Kč €	470,- 20,-	000931	efekt „sklo“	Kč €	560,- 24,-	000955
				RAL barvy	Kč €	560,- 24,-	080681

více informací na str. 318 - 319 Kování na sklo



	SNI		SNI - broušeno		Cr		Ms		TiN-C		TiN-B		TiN-K		
	cena	EAN	cena	EAN	cena	EAN	cena	EAN	cena	EAN	cena	EAN	cena	EAN	
	pár		pár		pár		pár		pár		pár		pár		
Minimal	Kč €	7080,- 295,-	000962	7240,- 302,-	000979	7420,- 310,-	000986	7420,- 310,-	061451	8300,- 346,-	000993	8300,- 346,-	001006	8300,- 346,-	001013
Maximal	Kč €	7580,- 316,-	001037	7760,- 324,-	001044	7940,- 331,-	001051	7940,- 331,-	061468	8780,- 366,-	001068	8780,- 366,-	001075	8780,- 366,-	001082

	cena	EAN		cena	EAN		
	pár			pár			
dřevo	Kč €	470,- 20,-	001105	kůže	Kč €	560,- 24,-	001129
kov	Kč €	470,- 20,-	001112	efekt „sklo“	Kč €	560,- 24,-	001136
				RAL barvy	Kč €	560,- 24,-	080698



	SNI		SNI - broušeno		Cr		Ms		TiN-C		TiN-B		TiN-K		
	cena	EAN	cena	EAN	cena	EAN	cena	EAN	cena	EAN	cena	EAN	cena	EAN	
	pár		pár		pár		pár		pár		pár		pár		
Minimal	Kč €	5260,- 220,-	002522	5330,- 223,-	002539	5440,- 227,-	002546	5440,- 227,-	060997	6830,- 285,-	002553	6830,- 285,-	002560	6830,- 285,-	002577
Maximal	Kč €	5260,- 220,-	002591	5330,- 223,-	002607	5440,- 227,-	002614	5440,- 227,-	061000	6830,- 285,-	002621	6830,- 285,-	002638	6830,- 285,-	002645

více informací na str. 308 - 311 Mušle na skleněné posuvné dveře

	SNI		SNI - broušeno		Cr		Ms		TiN-C		TiN-B		TiN-K		
	cena	EAN	cena	EAN	cena	EAN	cena	EAN	cena	EAN	cena	EAN	cena	EAN	
	ks		ks		ks		ks		ks		ks		ks		
Minimal	Kč €	2730,- 114,-	001815	2800,- 117,-	001822	2910,- 122,-	001839	2910,- 122,-	059694	3400,- 142,-	001846	3400,- 142,-	001853	3400,- 142,-	001860
Minimal zapuštěná	Kč €	2960,- 124,-	071085	3040,- 127,-	071092	3140,- 131,-	071108	3140,- 131,-	071115	3630,- 152,-	071139	3630,- 152,-	071153	3630,- 152,-	071146
Maximal	Kč €	3060,- 128,-	001884	3130,- 131,-	001891	3220,- 135,-	001907	2810,- 118,-	059700	3710,- 155,-	001914	3710,- 155,-	001921	3710,- 155,-	001938
Maximal zapuštěná	Kč €	3300,- 138,-	071177	3390,- 142,-	071184	3460,- 145,-	071191	3460,- 145,-	071207	3950,- 165,-	071221	3950,- 165,-	071245	3950,- 165,-	071238

více informací na str. 262 - 269 Okenní kliky 3 a 4 polohové, u zapuštěné okenní kliky Minimal, Maximal je polohovací mechanismus 3-polohový a je přímo součástí kliky



MINIMAL TiN-C titan chrom mat



MINIMAL TiN-K titan černý mat



MAXIMAL SNI matný nikel  
výplň dřevo teak

**Klika 225 mm Minimal**  
k posuvným systémům HS portal

7050,- Kč  
294,- EUR

**Klika 225 mm Maximal**  
k posuvným systémům HS portal

7370,- Kč  
308,- EUR

**Výplň kliky 225 mm**  
Maximal

630,- Kč  
27,- EUR



TiN-C titan chrom mat



TiN-K titan černý mat



SNI matný nikel

**Mušle Minimal venkovní**  
k dveřním systémům HS portal

2970,- Kč  
124,- EUR



MINIMAL Cr lesklý chrom

**Kliky Minimal pro Al profily**

4870,- Kč  
203,- EUR

materiál: masivní mosaz  
povrch: SNI matný nikel

**KČ** **EUR**

7050,- 294,-

14070,- 587,-

14210,- 593,-

2970,- 124,-

3060,- 128,-

7370,- 308,-

14700,- 613,-

14810,- 618,-

materiál: masivní mosaz  
povrch: SNI matný nikel

**KČ** **EUR**

2970,- 124,-

3060,- 128,-

materiál: masivní mosaz  
povrch: SNI matný nikel

**KČ** **EUR**

4870,- 203,-

5530,- 231,-

5530,- 231,-

840,- 35,-



		SNI		SNI - broušeno		Cr		Ms		TiN-C		TiN-B		TiN-K	
		cena	EAN	cena	EAN	cena	EAN	cena	EAN	cena	EAN	cena	EAN	cena	EAN
jednostranná	Kč €	ks 7050,- 294,-	001990	ks 7290,- 304,-	002003	ks 7470,- 312,-	002010	ks 7470,- 312,-	059731	ks 8700,- 363,-	002027	ks 8700,- 363,-	002034	ks 8700,- 363,-	002041
oboustranná	Kč €	pár 14070,- 587,-	002065	pár 14540,- 606,-	002072	pár 14900,- 621,-	002089	pár 14900,- 621,-	059748	pár 17380,- 725,-	002096	pár 17380,- 725,-	002102	pár 17380,- 725,-	002119
oboustranná s cylindr. otvorem	Kč €	pár 14210,- 593,-	002133	pár 14660,- 611,-	002140	pár 15030,- 627,-	002157	pár 15030,- 627,-	059755	pár 17490,- 729,-	002164	pár 17490,- 729,-	002171	pár 17490,- 729,-	002188
mušle venk.	Kč €	ks 2970,- 124,-	002201	ks 3110,- 130,-	002218	ks 3220,- 135,-	002225	ks 3220,- 135,-	059915	ks 3500,- 146,-	002232	ks 3500,- 146,-	002249	ks 3500,- 146,-	002256
mušle venk. s cylindr. otvorem	Kč €	ks 3060,- 128,-	022544	ks 3160,- 132,-	022551	ks 3300,- 138,-	022568	ks 3300,- 138,-	059922	ks 3620,- 151,-	022575	ks 3620,- 151,-	022582	ks 3620,- 151,-	022599

jednostranná	Kč €	ks 7370,- 308,-	002270	ks 7590,- 317,-	002287	ks 7800,- 325,-	002294	ks 7800,- 325,-	059793	ks 9030,- 377,-	002300	ks 9030,- 377,-	002317	ks 9030,- 377,-	002324
oboustranná	Kč €	pár 14700,- 613,-	002348	pár 15140,- 631,-	002355	pár 15510,- 647,-	002362	pár 15510,- 647,-	059809	pár 17990,- 750,-	002379	pár 17990,- 750,-	002386	pár 17990,- 750,-	002393
oboustranná s cylindr. otvorem	Kč €	pár 14810,- 618,-	002416	pár 15280,- 637,-	002423	pár 15630,- 652,-	002430	pár 15630,- 652,-	059816	pár 18100,- 755,-	002447	pár 18100,- 755,-	002454	pár 18100,- 755,-	002461

		cena	EAN
		ks	
dřevo	Kč €	630,- 27,-	002485
kov	Kč €	630,- 27,-	002492
kůže	Kč €	750,- 32,-	002508
efekt „sklo“	Kč €	750,- 32,-	002515
RAL barvy	Kč €	780,- 33,-	022513

více informací na str. 270 - 273 HS portaly



		SNI		SNI - broušeno		Cr		Ms		TiN-C		TiN-B		TiN-K	
		cena	EAN	cena	EAN	cena	EAN	cena	EAN	cena	EAN	cena	EAN	cena	EAN
mušle venkovní	Kč €	ks 2970,- 124,-	002201	ks 3110,- 130,-	002218	ks 3220,- 135,-	002225	ks 3220,- 135,-	059915	ks 3500,- 146,-	002232	ks 3500,- 146,-	002249	ks 3500,- 146,-	002256
mušle venk. s cylindr. otvorem	Kč €	ks 3060,- 128,-	022544	ks 3160,- 132,-	022551	ks 3300,- 138,-	022568	ks 3300,- 138,-	059922	ks 3620,- 151,-	022575	ks 3620,- 151,-	022582	ks 3620,- 151,-	022599

		SNI		SNI - broušeno		Cr		Ms		TiN-C		TiN-B		TiN-K	
		cena	EAN	cena	EAN	cena	EAN	cena	EAN	cena	EAN	cena	EAN	cena	EAN
klíka / klíka	Kč €	pár 4870,- 203,-	003062	pár 4940,- 206,-	003079	pár 5170,- 216,-	003086	pár 5170,- 216,-	060256	pár 6350,- 265,-	003093	pár 6350,- 265,-	003109	pár 6350,- 265,-	003116
madlo / klíka R	Kč €	pár 5530,- 231,-	003130	pár 5610,- 234,-	003147	pár 5820,- 243,-	003154	pár 5820,- 243,-	060263	pár 7010,- 293,-	003161	pár 7010,- 293,-	003178	pár 7010,- 293,-	003185
madlo / klíka L	Kč €	pár 5530,- 231,-	003208	pár 5610,- 234,-	003215	pár 5820,- 243,-	003222	pár 5820,- 243,-	060270	pár 7010,- 293,-	003239	pár 7010,- 293,-	003246	pár 7010,- 293,-	003253
rozeta cylindrická 33x47 mm	Kč €	pár 840,- 35,-	001952	pár 880,- 37,-	001969	pár 930,- 39,-	001976	pár 930,- 39,-	060775	pár 1330,- 56,-	001983	pár 1330,- 56,-	002669	pár 1330,- 56,-	002676

více informací na str. 278 - 281 Kování pro hliníkové a ocelové dveře



MINIMAL TiN-K titan černý mat



MINIMAL TiN-B titan braun mat



MAXIMAL SNI matný nikl  
výplň dřevo teak

**Madlo dlouhé Minimal**  
rozteč 250 / délka 297 mm

12260,- Kč  
511,- EUR

**Madlo dlouhé Maximal**  
rozteč 250 / délka 297 mm

12680,- Kč  
529,- EUR

**Výplň madla Maximal**

630,- Kč  
27,- EUR

**KČ** materiál: masivní mosaz povrch: SNI matný nikl **EUR**

12260,-		511,-
6150,-		257,-

12680,-		529,-
6360,-		265,-

--	--	--



SNI matný nikl



TiN-K titan černý mat



TiN-B titan braun mat

**Bezpečnostní rozeta Minimal**

4650,- Kč  
194,- EUR

**KČ** materiál: zušlechťená ocel povrch: SNI matný nikl **EUR**

pro tl. dveří		
4650,-	38 - 45 mm	194,-
4820,-	46 - 52 mm	201,-
4980,-	53 - 60 mm	208,-
5280,-	61 - 68 mm	220,-
5430,-	69 - 76 mm	227,-
5590,-	77 - 83 mm	233,-
5910,-	84 - 90 mm	247,-
6210,-	91 - 97 mm	259,-
6510,-	98 - 104 mm	272,-
6820,-	105 - 112 mm	285,-
7150,-	113 - 118 mm	298,-
7460,-	119 - 126 mm	311,-





		SNI		SNI - broušeno		Cr		Ms		TiN-C		TiN-B		TiN-K	
		cena	EAN	cena	EAN	cena	EAN	cena	EAN	cena	EAN	cena	EAN	cena	EAN
oboustranné	Kč €	pár 12260,- 511,-	002706	pár 12610,- 526,-	002713	pár 13000,- 542,-	002720	pár 13000,- 542,-	058819	pár 15350,- 640,-	002737	pár 15350,- 640,-	002744	pár 15350,- 640,-	002751
jednostranné	Kč €	ks 6150,- 257,-	002775	ks 6310,- 263,-	002782	ks 6510,- 272,-	002799	ks 6510,- 272,-	058826	ks 7690,- 321,-	002805	ks 7690,- 321,-	002812	ks 7690,- 321,-	002829
oboustranné	Kč €	pár 12680,- 529,-	002843	pár 13040,- 544,-	002850	pár 13390,- 558,-	002867	pár 13390,- 558,-	058857	pár 15830,- 660,-	002874	pár 15830,- 660,-	002881	pár 15830,- 660,-	002898
jednostranné	Kč €	ks 6360,- 265,-	002911	ks 6530,- 273,-	002928	ks 6710,- 280,-	002935	ks 6710,- 280,-	058864	ks 7930,- 331,-	002942	ks 7930,- 331,-	002959	ks 7930,- 331,-	002966

	cena	EAN	více informací na str. 218 - 221 Dlouhá madla				cena	EAN		cena	EAN			
	ks					Montážní materiál pro madla	sada		Montážní materiál pro madla	sada				
dřevo	Kč €	630,- 27,-	002980				jednostranné do slepé díry - plast	Kč €	420,- 18,-	030204	jednostranné s prošroubováním a záslepkou	Kč €	420,- 18,-	003024
kov	Kč €	630,- 27,-	002997				jednostranné do slepé díry - hliník	Kč €	420,- 18,-	030211	jednostranné na sklo s prošroubováním a záslepkou	Kč €	550,- 23,-	003031
kůže	Kč €	750,- 32,-	003000				jednostranné do slepé díry - dřevo	Kč €	420,- 18,-	030228	oboustranné	Kč €	420,- 18,-	003048
efekt „sklo“	Kč €	750,- 32,-	003017								oboustranné na sklo	Kč €	550,- 23,-	003055
RAL barvy	Kč €	780,- 33,-	022520											

		SNI		SNI - broušeno		Cr		TiN-C		TiN-B		TiN-K		K-industrial	
		cena	EAN	cena	EAN	cena	EAN	cena	EAN	cena	EAN	cena	EAN	cena	EAN
		ks		ks		ks		ks		ks		ks		ks	
pro tl. dveří															
38 - 45 mm	Kč €	4650,- 194,-	020977	4650,- 194,-	021097	4820,- 201,-	021219	5430,- 227,-	021332	5430,- 227,-	021455	5430,- 227,-	021578	5430,- 227,-	142655
46 - 52 mm	Kč €	4820,- 201,-	020984	4820,- 201,-	021103	4980,- 208,-	021226	5590,- 233,-	021349	5590,- 233,-	021462	5590,- 233,-	021585	5590,- 233,-	142662
53 - 60 mm	Kč €	4980,- 208,-	020991	4980,- 208,-	021110	5120,- 214,-	021233	5740,- 240,-	021356	5740,- 240,-	021479	5740,- 240,-	021592	5740,- 240,-	142679
61 - 68 mm	Kč €	5280,- 220,-	021004	5280,- 220,-	021127	5430,- 227,-	021240	6060,- 253,-	021363	6060,- 253,-	021486	6060,- 253,-	021608	6060,- 253,-	142686
69 - 76 mm	Kč €	5430,- 227,-	021011	5430,- 227,-	021134	5590,- 233,-	021257	6210,- 259,-	021370	6210,- 259,-	021493	6210,- 259,-	021615	6210,- 259,-	142693
77 - 83 mm	Kč €	5590,- 233,-	021028	5590,- 233,-	021141	5740,- 240,-	021264	6360,- 265,-	021387	6360,- 265,-	021509	6360,- 265,-	021622	6360,- 265,-	142709
84 - 90 mm	Kč €	5910,- 247,-	021035	5910,- 247,-	021158	6060,- 253,-	021271	6680,- 279,-	021394	6680,- 279,-	021516	6680,- 279,-	021639	6680,- 279,-	142716
91 - 97 mm	Kč €	6210,- 259,-	021042	6210,- 259,-	021165	6360,- 265,-	021288	6980,- 291,-	021400	6980,- 291,-	021523	6980,- 291,-	021646	6980,- 291,-	142723
98 - 104 mm	Kč €	6510,- 272,-	021059	6510,- 272,-	021172	6680,- 279,-	021295	7290,- 304,-	021417	7290,- 304,-	021530	7290,- 304,-	021653	7290,- 304,-	142730
105 - 112 mm	Kč €	6820,- 285,-	021066	6820,- 285,-	021189	6980,- 291,-	021301	7610,- 318,-	021424	7610,- 318,-	021547	7610,- 318,-	021660	7610,- 318,-	142747
113 - 118 mm	Kč €	7150,- 298,-	021073	7150,- 298,-	021196	7290,- 304,-	021318	7910,- 330,-	021431	7910,- 330,-	021554	7910,- 330,-	021677	7910,- 330,-	142754
119 - 126 mm	Kč €	7460,- 311,-	021080	7460,- 311,-	021202	7610,- 318,-	021325	8230,- 343,-	021448	8230,- 343,-	021561	8230,- 343,-	021684	8230,- 343,-	142761

více informací na str. 210 - 217 Bezpečnostní rozety



## **Minimal 2.0 WC integrated**

minimalistické maximum

v působivém celku je hodinářským způsobem  
integrován systém komfortního zamykání  
a zároveň skrytého nouzového otevření

design: Roman Ulich

Dveřní kliky DESIGN 2021 **Minimal 2.0, Minimal 2.0 WC integrated**



Materiál: masivní mosaz

Povrchy: SNI, SNI-broušeno, Cr, TiN-A, TiN-C, TiN-B, TiN-K, Ms, Ms-L, Ms-A, Cr-K  
více info na [www.kliky-mt.cz/manufaktura/barvy-povrchy](http://www.kliky-mt.cz/manufaktura/barvy-povrchy)

Konstrukce, mechanika: mosazné rozety 53x33 mm, mechanika M2011 Minimal

**MINIMAL 2.0**

**Cr-K** černý chrom broušený



Klika/klika



Madlo/klika R



Madlo/klika L

**MINIMAL 2.0 WC integrated**

**TiN-A** titan mosaz mat



Klika/klika R WC integrated



Klika/klika L WC integrated



Rozety dozické



Rozety WC



Rozety zaslepovací 53x33 mm



Rozety cylindrické 47x47 mm



Rozety zaslepovací 47x47 mm



dozické



WC in



WC ex



zaslepovací



madlo Minimal 2.0



cylindrické



zaslepovací

rozety 53x33 mm

rozety 47x47 mm

konstrukční varianty, materiálové provedení

- designová sada standardně bez spodních rozet
- spodní rozety se objednávají samostatně
- konstrukční systém 4 tlačných pružin u kliky
- velmi tichý chod celého systému
- montáž sešroubování pouzdry proti sobě
- další pomocná fixace s 8 vruty
- samostatná fixace rozety červíky 2x M4
- rukojeti vyrobeny z masivní mosazi
- rozety vyrobeny z masivní mosazi
- zajišťovací gel proti uvolnění šroubů
- vrtání PROFI šablonou M&T vrtákem Ø 6,4 mm
- animace montáže na [www.kliky-mt.cz/montaze-kovani](http://www.kliky-mt.cz/montaze-kovani)
- montáž pro tloušťky dveří 38,5 – 124 mm
- možnost dodání v protipožárním provedení
- v balení standardně montážní materiál pro tl. dveří 38,5 – 44 mm
- čtvercové rozety 47x47 mm pro cylindrickou, nebo zaslepovací variantu
- čtyřhrany pro WC integrated jsou odstupňovány v délkách po 5 mm, nutno do objednávky uvádět přesnou tloušťku dveří od dveří tloušťky 44 mm
- záruka 3 roky, titany 15 let

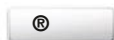
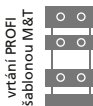

Ochranné známky – registrované značky **MINIMAL®**



Chráněné průmyslové vzory klik

**MINIMAL 2.0  
MINIMAL 2.0 WC  
INTEGRATED**



Patenty

- konstrukce blokování + nouzového otevření kliky Minimal 2.0 WC integrated

roky

**3 garance**

let

**15 garance**



MINIMAL 2.0 **TiN-K** titan černý mat

**Minimal 2.0**

4390,- Kč  
183,- EUR

Kč	materiál: masivní mosaz povrch: SNi matný nikel	EUR
4390,-		183,-
5090,-		213,-
5090,-		213,-



MINIMAL 2.0 **SNi-broušeno** matný nikel-broušený



MINIMAL 2.0 **TiN-A** titan mosaz mat



Madlo MINIMAL 2.0 **TiN-A** titan mosaz mat

**Spodní rozety**

960,- Kč  
40,- EUR

Kč	materiál: masivní mosaz povrch: SNi matný nikel	EUR
960,-		40,-
1120,-		47,-
1740,-		73,-
2100,-		88,-



Protipožární provedení (kovové podrozety + nerezové spojovací prvky, čtyřhran) ... příplatek 520,- Kč ... EAN 082289  
Minimal Objekt (kovové podrozety s mechanikou v 6-ti jisticích bodech) ... příplatek 340,- Kč ... EAN 082272  
Panikové provedení = Minimal Objekt + doobjednání správného děleného čtyřhranu na str. 369.

		SNI		SNI - broušeno		Cr		Ms		Ms-L		Ms-A	
		cena pár	EAN	cena pár	EAN	cena pár	EAN	cena pár	EAN	cena pár	EAN	cena pár	EAN
klika / klika	Kč €	4390,- 183,-	147438	4500,- 188,-	147483	4730,- 198,-	147537	4730,- 198,-	147582	4730,- 198,-	147636	4730,- 198,-	147681
madlo / klika R	Kč €	5090,- 213,-	147469	5220,- 218,-	147513	5420,- 226,-	147568	5420,- 226,-	147612	5420,- 226,-	147667	5420,- 226,-	147711
madlo / klika L	Kč €	5090,- 213,-	147476	5220,- 218,-	147520	5420,- 226,-	147575	5420,- 226,-	147629	5420,- 226,-	147674	5420,- 226,-	147728

		TiN-C		TiN-K		TiN-B		TiN-A		Cr-K	
		cena pár	EAN	cena pár	EAN	cena pár	EAN	cena pár	EAN	cena pár	EAN
klika / klika	Kč €	5730,- 239,-	147735	5730,- 239,-	147780	5730,- 239,-	147834	5730,- 239,-	147889	6480,- 270,-	147933
madlo / klika R	Kč €	6590,- 275,-	147766	6590,- 275,-	147810	6590,- 275,-	147865	6590,- 275,-	147919	7280,- 304,-	147964
madlo / klika L	Kč €	6590,- 275,-	147773	6590,- 275,-	147827	6590,- 275,-	147872	6590,- 275,-	147926	7280,- 304,-	147971



MINIMAL 2.0 Cr-K černý chrom broušený 3D



MINIMAL 2.0 SNI matný nikel

		SNI		SNI - broušeno		Cr		Ms		Ms-L		Ms-A	
		cena pár	EAN	cena pár	EAN	cena pár	EAN	cena pár	EAN	cena pár	EAN	cena pár	EAN
dozické	Kč €	960,- 40,-	147988	1010,- 43,-	148039	1120,- 47,-	148084	1120,- 47,-	148138	1120,- 47,-	148183	1120,- 47,-	148237
zaslepovací	Kč €	1120,- 47,-	147995	1180,- 50,-	148046	1280,- 54,-	148091	1280,- 54,-	148145	1280,- 54,-	148190	1280,- 54,-	148244
WC	Kč €	1740,- 73,-	148015	1840,- 77,-	148060	1930,- 81,-	148114	1930,- 81,-	148169	1930,- 81,-	148213	1930,- 81,-	148268
WC double	Kč €	2100,- 88,-	147025	2200,- 92,-	148077	2290,- 96,-	148121	2290,- 96,-	148176	2290,- 96,-	148220	2290,- 96,-	148275

		TiN-C		TiN-K		TiN-B		TiN-A		Cr-K	
		cena pár	EAN	cena pár	EAN	cena pár	EAN	cena pár	EAN	cena pár	EAN
dozické	Kč €	1280,- 54,-	148282	1280,- 54,-	148336	1280,- 54,-	148381	1280,- 54,-	148435	1520,- 64,-	148480
zaslepovací	Kč €	1450,- 61,-	148299	1450,- 61,-	148343	1450,- 61,-	148398	1450,- 61,-	148442	1680,- 70,-	148497
WC	Kč €	2790,- 117,-	148312	2790,- 117,-	148367	2790,- 117,-	148411	2790,- 117,-	148466	3200,- 134,-	148510
WC double	Kč €	3140,- 131,-	148329	3140,- 131,-	148374	3140,- 131,-	148428	3140,- 131,-	148473	3550,- 148,-	148527



MINIMAL 2.0 WC integrated **SNi** matný nikel

**Minimal 2.0  
WC integrated**

6830,- Kč  
285,- EUR

**Kč** materiál: masivní mosaz povrch: **SNi matný nikel** **EUR**

6830,-  285,-

6830,-  285,-



MINIMAL 2.0 WC integrated **Cr-K** černý chrom broušený 3D



MINIMAL 2.0 WC integrated **TiN-A** titan mosaz mat

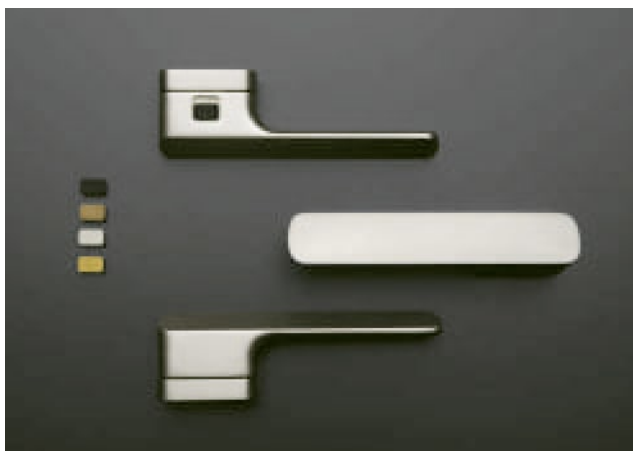

Automaticky dodáváme celé kování včetně ovládacího / blokovacího segmentu vždy v jednotném povrchu. Zakázkově lze u WC integrated zvolit odlišnou povrchovou úpravu ovládacího / blokovacího segmentu, tzn. odlišit dotykovou / ovládací plochu oproti povrchu celé kliky.

**Spodní rozety**

1160,- Kč  
49,- EUR

**Kč** materiál: masivní mosaz povrch: **SNi matný nikel** **EUR**

1160,-  49,-

1330,-  56,-



MINIMAL 2.0 WC integrated **TiN-K** titan černý mat



		SNI		SNI - broušeno		Cr		Ms		Ms-L		Ms-A	
		cena pár	EAN	cena pár	EAN	cena pár	EAN	cena pár	EAN	cena pár	EAN	cena pár	EAN
klika / klika R WC integrated	Kč €	6830,- 285,-	147445	7090,- 296,-	147490	7580,- 316,-	147544			7580,- 316,-	147643	7580,- 316,-	147698
klika / klika L WC integrated	Kč €	6830,- 285,-	147452	7090,- 296,-	147506	7580,- 316,-	147551			7580,- 316,-	147650	7580,- 316,-	147704

		TiN-C		TiN-K		TiN-B		TiN-A		Cr-K	
		cena pár	EAN	cena pár	EAN	cena pár	EAN	cena pár	EAN	cena pár	EAN
klika / klika R WC integrated	Kč €	8750,- 365,-	147742	8750,- 365,-	147797	8750,- 365,-	147841	8750,- 365,-	147896	9790,- 408,-	147940
klika / klika L WC integrated	Kč €	8750,- 365,-	147759	8750,- 365,-	147803	8750,- 365,-	147858	8750,- 365,-	147902	9790,- 408,-	147957

Konstrukce klik se systémem WC integrated vyžaduje dodání vždy přesné délky ovládacího čtyřhranu a dalších komponentů pro konkrétní tloušťku dveří viz. tabulka montážního materiálu pro tloušťky dveří po 5 mm. Montážní materiál pro standardní tloušťku dveří 38,5 - 44 mm je součástí dodávky a je v ceně dodávky.



MINIMAL 2.0 WC integrated TiN-B titan braun mat

Rozměrové varianty							
tloušťka dveří		cena sada	EAN	tloušťka dveří	cena sada	EAN	
44,1 - 49 mm	Kč €	140,- 5,9	145014	64,1 - 69 mm	Kč €	270,- 12,-	145052
49,1 - 54 mm	Kč €	170,- 7,1	145021	69,1 - 74 mm	Kč €	300,- 13,-	145069
54,1 - 59 mm	Kč €	200,- 8,4	145038	74,1 - 79 mm	Kč €	330,- 14,-	145076
59,1 - 64 mm	Kč €	230,- 9,6	145045	79,1 mm a více*	Kč €	390,- 17,-	145083

\* nutno určit přesnou tloušťku dveří

		SNI		SNI - broušeno		Cr		Ms		Ms-L		Ms-A	
		cena pár	EAN	cena pár	EAN	cena pár	EAN	cena pár	EAN	cena pár	EAN	cena pár	EAN
cylindrické 47x47 mm	Kč €	1160,- 49,-	000535	1220,- 51,-	000542	1330,- 56,-	000559	1330,- 56,-	055191	1330,- 56,-	055276	1330,- 56,-	148503
zaslepovací 47x47 mm	Kč €	1330,- 56,-	022421	1380,- 58,-	022438	1490,- 63,-	022445	1490,- 63,-	055207	1490,- 63,-	055283	1650,- 69,-	152623

		TiN-C		TiN-K		TiN-B		TiN-A		Cr-K	
		cena pár	EAN	cena pár	EAN	cena pár	EAN	cena pár	EAN	cena pár	EAN
cylindrické 47x47 mm	Kč €	1490,- 63,-	000566	1490,- 63,-	000580	1490,- 63,-	000573	1490,- 63,-	000597	1910,- 80,-	087703
zaslepovací 47x47 mm	Kč €	1650,- 69,-	022452	1650,- 69,-	022476	1650,- 69,-	022469	1650,- 69,-	022483		



**Zámek na sklo**

**Kč** materiál: masivní mosaz povrch: SNI matný nikl **EUR**

**Minimal**

7080,-



295,-

7080,- Kč  
295,- EUR

Kompletní sada na sklo se skládá ze zámku na sklo Minimal a klik s rozetou (tj. klika stejná jako u dřevěných dveří, která se i s rozetou montuje na zámek na sklo).

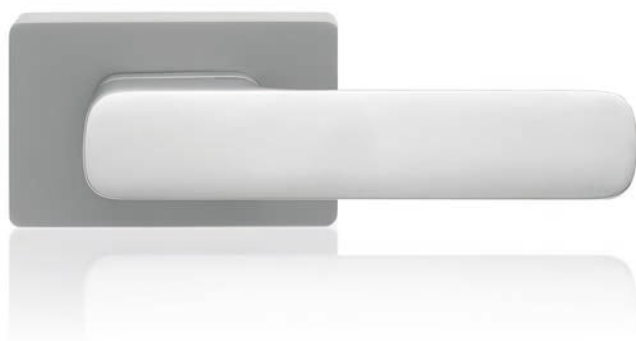

**Kliky-rukojeti k zámkům na sklo**

**Kč** materiál: masivní mosaz povrch: SNI matný nikl **EUR**

4390,-



183,-

6830,-



285,-

6830,-



285,-

zámek na sklo



klika-rukojet



levá



pravá

**Okenní klika**

**Kč** materiál: masivní mosaz povrch: SNI matný nikl **EUR**

**Minimal 2.0**

2940,-



123,-

2940,- Kč  
123,- EUR

2940,-

123,-



		SNI		SNI - broušeno		Cr		Ms		Ms-L		Ms-A	
		cena	EAN	cena	EAN	cena	EAN	cena	EAN	cena	EAN	cena	EAN
		pár		pár		pár		pár		pár		pár	
Minimal standard	Kč €	7080,- 295,-	000788	7240,- 302,-	000795	7420,- 310,-	000801	7420,- 310,-	061413	7420,- 310,-	061437	8180,- 341,-	155990

		TiN-C		TiN-K		TiN-B		TiN-A		Cr-K	
		cena	EAN	cena	EAN	cena	EAN	cena	EAN	cena	EAN
		pár		pár		pár		pár		pár	
Minimal standard	Kč €	8300,- 346,-	000818	8300,- 346,-	000832	8300,- 346,-	000825	8300,- 346,-	000849	8940,- 373,-	087871

Pro tl. dveří 10 mm jsou v případě potřeby připraveny zámkové se sníženou/užší střílkou o 2 mm... EAN 068498 příplatek ke katalogové ceně zámku + 730 Kč bez další slevy.

		SNI		SNI - broušeno		Cr		Ms		Ms-L		Ms-A	
		cena	EAN	cena	EAN	cena	EAN	cena	EAN	cena	EAN	cena	EAN
		pár		pár		pár		pár		pár		pár	
Minimal 2.0 klika / klika	Kč €	4390,- 183,-	147438	4500,- 188,-	147483	4730,- 198,-	147537	4730,- 198,-	147582	4730,- 198,-	147636	4730,- 198,-	147681
Minimal 2.0 WC integrated klika / klika R	Kč €	6830,- 285,-	147445	7090,- 296,-	147490	7580,- 316,-	147544			7580,- 316,-	147643	7580,- 316,-	147698
Minimal 2.0 WC integrated klika / klika L	Kč €	6830,- 285,-	147452	7090,- 296,-	147506	7580,- 316,-	147551			7580,- 316,-	147650	7580,- 316,-	147704

		TiN-C		TiN-K		TiN-B		TiN-A		Cr-K	
		cena	EAN	cena	EAN	cena	EAN	cena	EAN	cena	EAN
		pár		pár		pár		pár		pár	
Minimal 2.0 klika / klika	Kč €	5730,- 239,-	147735	5730,- 239,-	147780	5730,- 239,-	147834	5730,- 239,-	147889	6480,- 270,-	147933
Minimal 2.0 WC integrated klika / klika R	Kč €	8750,- 365,-	147742	8750,- 365,-	147797	8750,- 365,-	147841	8750,- 365,-	147896	9790,- 408,-	147940
Minimal 2.0 WC integrated klika / klika L	Kč €	8750,- 365,-	147759	8750,- 365,-	147803	8750,- 365,-	147858	8750,- 365,-	147902	9790,- 408,-	147957

		SNI		SNI - broušeno		Cr		Ms		Ms-L		Ms-A	
		cena	EAN	cena	EAN	cena	EAN	cena	EAN	cena	EAN	cena	EAN
		pár		pár		pár		pár		pár		pár	
pravá	Kč €	2940,- 123,-	155778	3020,- 126,-	155792	3120,- 130,-	155815	3120,- 130,-	155839	3120,- 130,-	155853	3440,- 144,-	155877
levá	Kč €	2940,- 123,-	155785	3020,- 126,-	155808	3120,- 130,-	155822	3120,- 130,-	155846	3120,- 130,-	155860	3440,- 144,-	155884

		TiN-C		TiN-K		TiN-B		TiN-A		Cr-K	
		cena	EAN	cena	EAN	cena	EAN	cena	EAN	cena	EAN
		pár		pár		pár		pár		pár	
pravá	Kč €	3610,- 151,-	155891	3610,- 151,-	155914	3610,- 151,-	155938	3610,- 151,-	155952	3980,- 166,-	155976
levá	Kč €	3610,- 151,-	155907	3610,- 151,-	155921	3610,- 151,-	155945	3610,- 151,-	155969	3980,- 166,-	155983

## Minimal 2.0

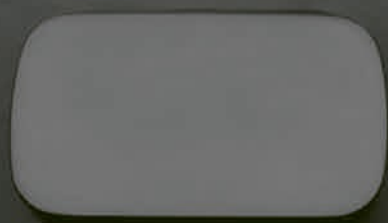
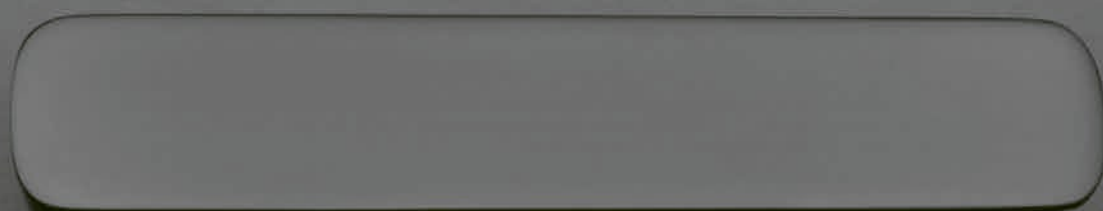

Nezaměnitelný organický tvar

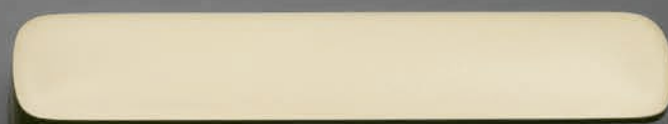
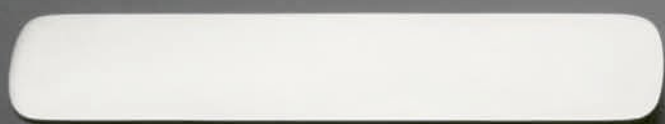

Dokonalá ergonomie

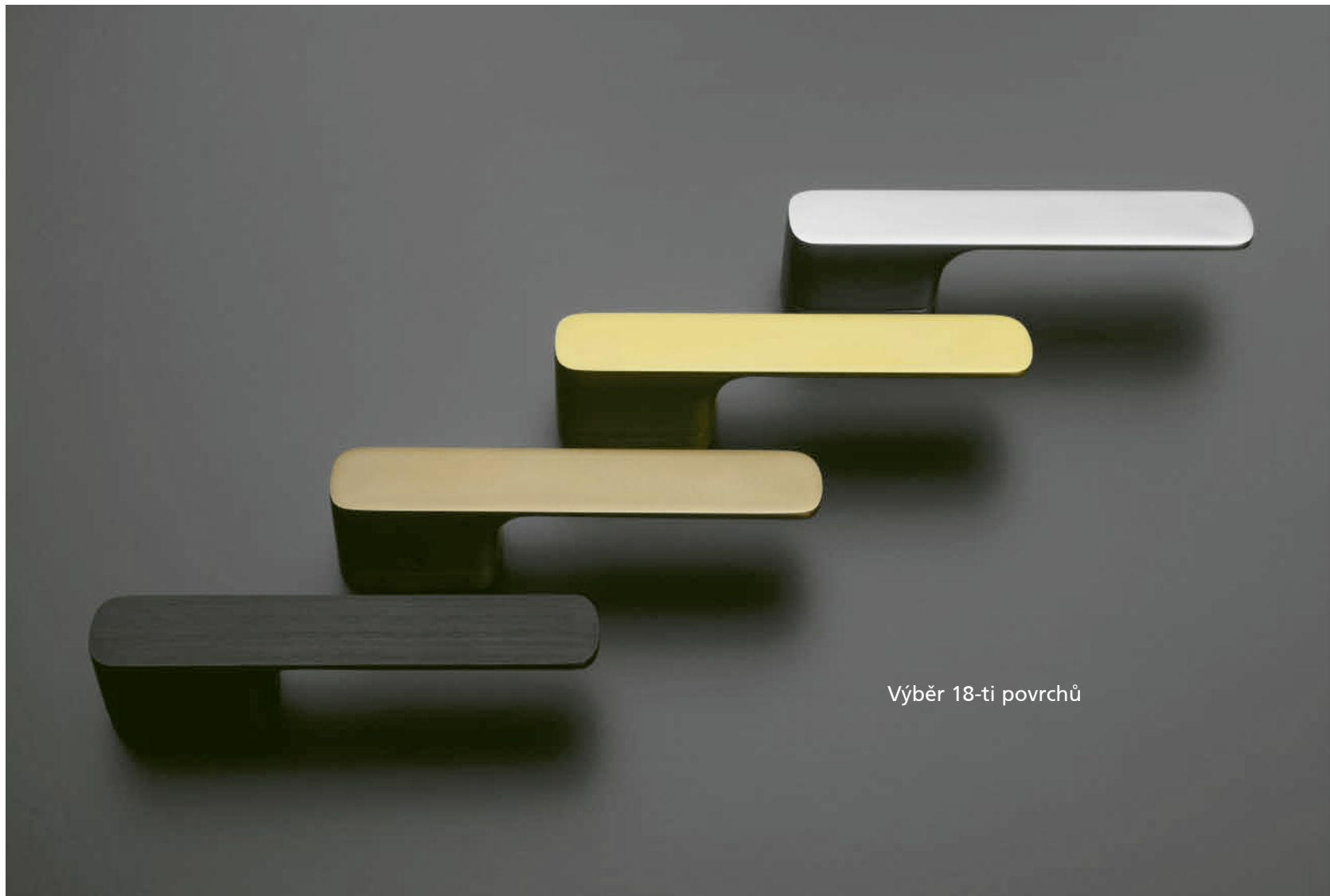

Výběr 18-ti povrchů

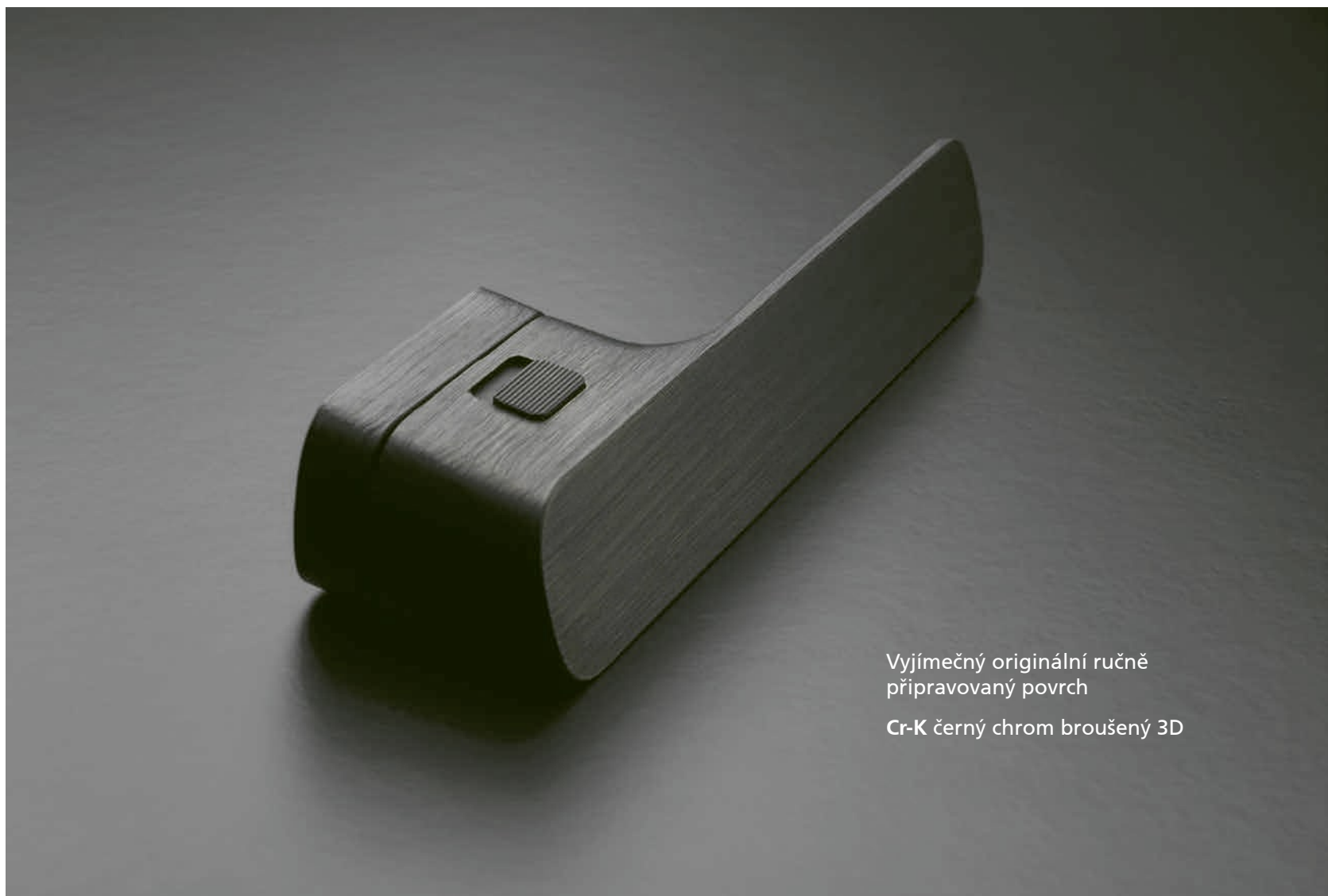

Vyjímečný originální ručně  
připravovaný povrch  
Cr-K černý chrom broušený 3D

## Minimal 2.0 WC integrated



### Integrované WC zamykání

(blokuje se klika ne zámek .... systém funguje na všech dveřích s jakýmkoliv běžným zámek, tj. se zámek dozickým, WC, cylindrickým)

### Neviditelné nouzové S.O.S. otevření

(umístěné na vnější klice ze spodu .... stačí vsunout jakýkoliv předmět do úzké drážky a posunout blokovací mechanismus .... klika se na druhé straně dveří odjistí/odblokuje)





Možnosť volby barevného povrchu  
uzamykacího segmentu

(standardne sa dodáva v jednotnom povrchu s klikou)

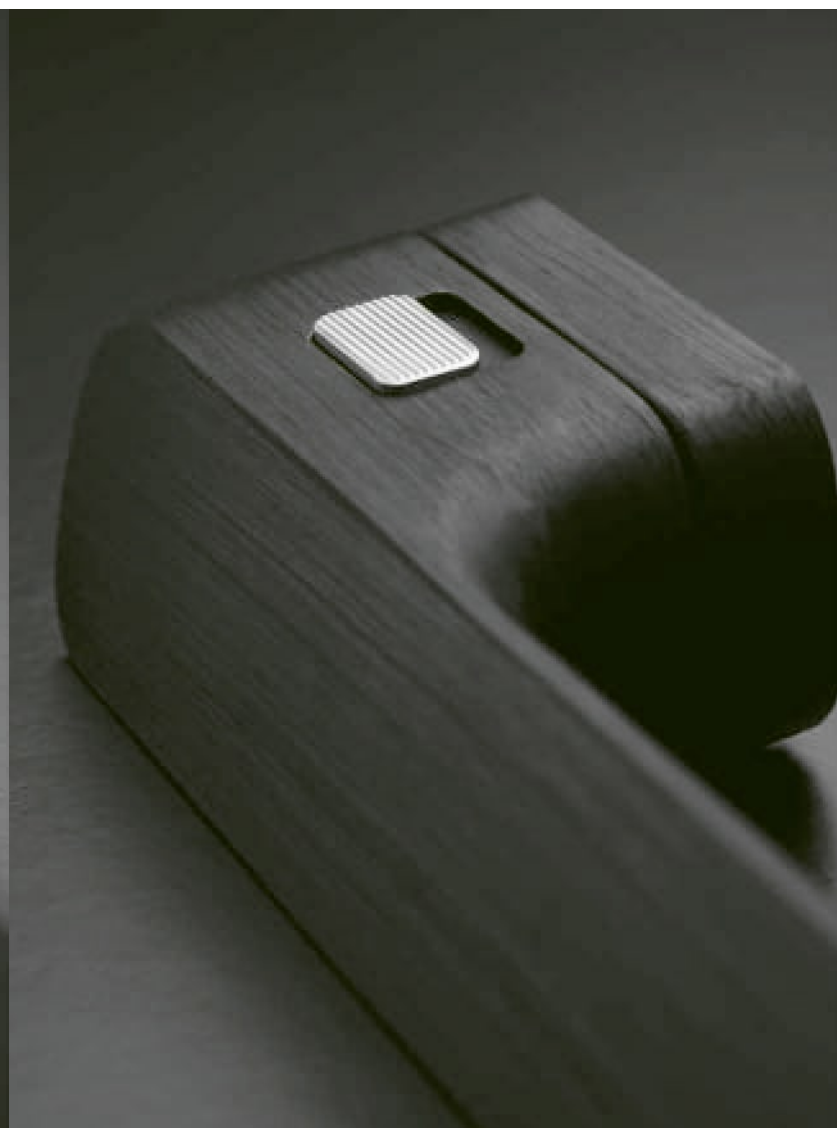

# MAG

## SYSTÉM NEODYM ULTRA MAGNET KONCEPT

rychle, pevně, pouhým nacvaknutím dlouhodobě fixuje krycí  
pohledové rozety k základně/vnitřní rozetě



ČTVERCOVÁ 54×54 mm

KULATÁ Ø 54 mm



## SYSTÉM FIX M6

fixace klik k ovládacímú čtyřhranu pomocí speciálně  
tvarovanému červíku M6, kdy se celá došedací plocha  
zatlačí do připravené drážky čtyřhranu a tím znemožní  
jakémukoliv pozdějšímu nechtěnému uvolnění kliky.

S červíkem dodáván zajišťovací gel zabráňující  
samovolnému uvolnění

# NETICKÉ ROZETY

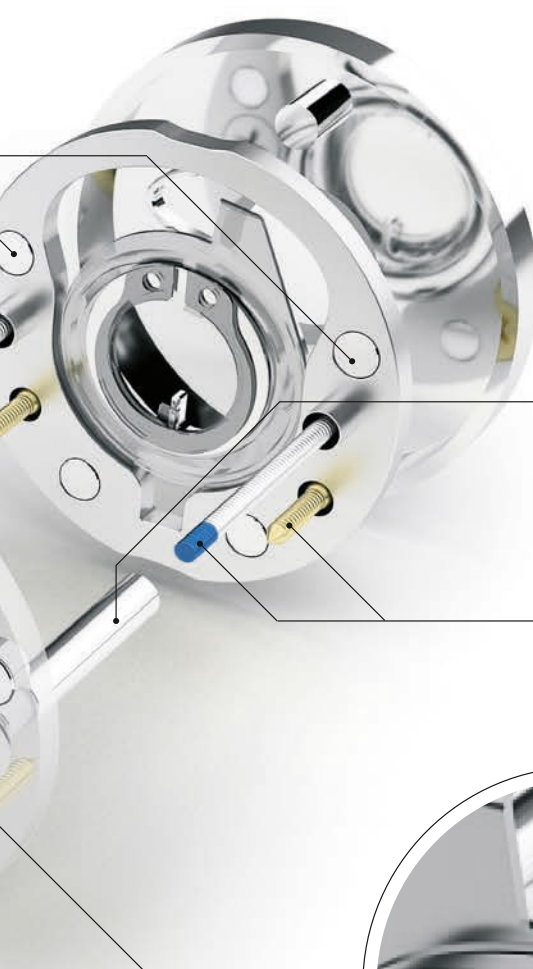

**SYSTÉM PROŠROUBOVÁNÍ  
BEZ MOŽNOSTI POTOČENÍ ROZET**  
přesné naváděcí válečky/pouzdra nasazené  
do předvrtaných otvorů ve dveřích zabrání  
jakémukoliv pohybu celé konstrukce rozet



**SYSTÉM FIXACE ŠROUBY TUFLOK®**  
s otěruvzdorným nylonovým povlakem dlouhodobě  
garantuje stabilitu celé konstrukce bez možnosti  
samovolného uvolnění + nabízí další 4 jistící body  
pomocí samořezných vrtů



**SYSTÉM 1 SPRING**  
optimální síly stlačení na kliku je dosaženo  
vratnou pružinou montážně připravenou  
pouze na jedné klice, další funkčnost  
zajišťuje dveřní zámek



**SYSTÉM  
KLUZNÝCH POUZDER**  
polymerová kluzná pouzdra precizně vedou  
kliky v rozetě a dlouhodobě zajišťují jejich tichý  
a bezvadný chod

**Mechanika 2018  
MAGNETIC system**

34 komponent

6 zásadních inovací

1 dokonalý celek



vrtání otvorů  
pro magnetické rozety

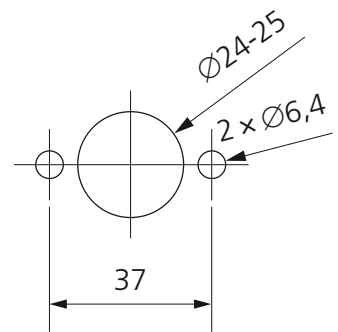

Celý projekt - jeden design

Kličky + magnetické rozety



Kličky a zámky na skleněné dveře



Madla a koule na skleněné  
a dřevěné dveře



Hranaté panty na dřevěné  
dveře



Okenní kličky  
3 a 4 polohové



Bezpečnostní madla  
Entero



Madla dlouhá



Kování pro hliníkové a ocelové dveře,  
kování na branky



Panty na skleněné dveře



Mušle na posuvné  
dveře



Bezpečnostní rozety





## Kliky + magnetické rozety DESIGN 2017

Materiál rozet: **magnetická nerez ocel**

Materiál klik: **masivní mosaz** 







Povrchy: **SNi, Cr, TiN-C, TiN-K, Ms, Ms-L, Ms-A, zakázkově TiN-A**  
více info na [www.kliky-mt.cz/manufaktura/barvy-povrchy](http://www.kliky-mt.cz/manufaktura/barvy-povrchy)

Konstrukce, mechanika: **magnetické rozety s 1 vratnou pružinou, mechanika M2018**

Nejdokonalejší a nejrychlejší systém montáže. Účinný systém, který dlouhodobě pevně fixuje kličky a MG rozety k dveřnímu křídlu bez možnosti jakéhokoliv pohybu rozet po dveřním křídle, bez možnosti poškrábání dveří. Tloušťka pouhých 5 mm předurčuje MG rozety ke kombinaci jak s projektovými, tak s designovými řadami dveřních klik.

### SOGUT **Ms-A** mosaz antik



-  Klika/klika
-  Koule/klika R
-  Koule/klika L
-  Rozeta dozická
-  Rozeta cylindrická
-  Rozety WC
-  Rozeta zaslepovací



dozická   cylindrické   zaslepovací   WC ex   WC in

magnetické rozety Ø 54 mm, tl. 5 mm



koule Maty

### ENTERO **Cr** lesklý chrom



-  Klika/klika
-  Madlo/klika R
-  Madlo/klika L
-  Rozeta dozická
-  Rozeta cylindrická
-  Rozety WC
-  Rozeta zaslepovací



dozická   cylindrické   zaslepovací   WC ex   WC in

magnetické rozety 54x54 mm, tl. 5 mm



madlo Entero

#### konstrukční varianty, materiálové provedení

- set kování s 1 vratnou pružinou
- standardně bez spodních rozet
- spodní rozety se objednávají samostatně
- sešroubování pouzdry proti sobě
- použité systémy viz. předcházející dvojstrana
- příprava do dveří: vrtání otvoru průměr 24 – 25 mm
- zajišťovací gel proti uvolnění červíků
- vrtání PROFÍ šablonou M&T vrtákem Ø 6,4 mm
- montáž pro tloušťky dveří 38 – 126 mm
- možnost dodání v protipožárním provedení
- v balení standardně montážní materiál pro tl. dveří 38 - 45 mm
- záruka 3 roky, titany 15 let

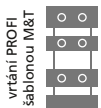

roky **3 garance** let **15 garance**

Ochranná známka – registrovaná značka

**ENTERO®**

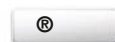

Chráněné průmyslové vzory klik



**ENTERO**  
**BURAK**  
**MIA**  
**SOGUT**



SNI matný nikel

**Cesan**

1760,- Kč  
74,- EUR

**Kč** materiál: masivní mosaz  
povrch: SNI matný nikel **EUR**

1760,-		74,-
2640,-		110,-
2640,-		110,-



TiN-K titan černý mat

**Cesan**

3100,- Kč  
130,- EUR

**Kč** materiál: masivní mosaz  
povrch: TiN-K titan černý mat **EUR**

3100,-		130,-
4130,-		173,-
4130,-		173,-



Ms-L mosaz leštěno

**Entero**

3330,- Kč  
139,- EUR

**Kč** materiál: masivní mosaz  
povrch: Ms-L mosaz leštěno **EUR**

3330,-		139,-
4210,-		176,-
4210,-		176,-



TiN-K titan černý mat

**Entero**

4040,- Kč  
169,- EUR

**Kč** materiál: masivní mosaz  
povrch: TiN-K titan černý mat **EUR**

4040,-		169,-
5070,-		212,-
5070,-		212,-



Magnetická rozeta											
		SNI		Cr		Ms		Ms-L		Ms-A	
		cena / pár	EAN	cena / pár	EAN	cena / pár	EAN	cena / pár	EAN	cena / pár	EAN
klika / klika	Kč €	1760,- 74,-	097153	2100,- 88,-	097160	2400,- 100,-	097177	2400,- 100,-	097184	2530,- 106,-	097191
koule / klika R	Kč €	2640,- 110,-	097207	2960,- 124,-	097214	3250,- 136,-	097221	3250,- 136,-	097238	3400,- 142,-	097245
koule / klika L	Kč €	2640,- 110,-	097252	2960,- 124,-	097269	3250,- 136,-	097276	3250,- 136,-	097283	3400,- 142,-	097290

U povrchů Ms, Ms-L, Ms-A je vždy rozeta pod klikou, spodní zámkové rozety, WC mechanismus v matném „zlatém provedení“ tj. povrch TiN-A.

Magnetická rozeta											
		TiN-A		TiN-C		TiN-B		TiN-K		Cr-K	
		cena / pár	EAN	cena / pár	EAN	cena / pár	EAN	cena / pár	EAN	cena / pár	EAN
klika / klika	Kč €	3100,- 130,-	097306	3100,- 130,-	097313	3100,- 130,-	097320	3100,- 130,-	097337	3410,- 143,-	097344
koule / klika R	Kč €	4130,- 173,-	097351	4130,- 173,-	097368	4130,- 173,-	097375	4130,- 173,-	097382	4540,- 190,-	097399
koule / klika L	Kč €	4130,- 173,-	097405	4130,- 173,-	097412	4130,- 173,-	097429	4130,- 173,-	097436	4540,- 190,-	097443



Magnetická rozeta											
		SNI		Cr		Ms		Ms-L		Ms-A	
		cena / pár	EAN	cena / pár	EAN	cena / pár	EAN	cena / pár	EAN	cena / pár	EAN
klika / klika	Kč €	2730,- 114,-	098952	3050,- 128,-	098969	3330,- 139,-	098976	3330,- 139,-	098983	3480,- 145,-	098990
koule / klika R	Kč €	3610,- 151,-	099003	3940,- 165,-	099010	4210,- 176,-	099027	4210,- 176,-	099034	4370,- 183,-	099041
koule / klika L	Kč €	3610,- 151,-	099058	3940,- 165,-	099065	4210,- 176,-	099072	4210,- 176,-	099089	4370,- 183,-	099096

U povrchů Ms, Ms-L, Ms-A je vždy rozeta pod klikou, spodní zámkové rozety, WC mechanismus v matném „zlatém provedení“ tj. povrch TiN-A.

Magnetická rozeta											
		TiN-A		TiN-C		TiN-B		TiN-K		Cr-K	
		cena / pár	EAN	cena / pár	EAN	cena / pár	EAN	cena / pár	EAN	cena / pár	EAN
klika / klika	Kč €	4040,- 169,-	099102	4040,- 169,-	099119	4040,- 169,-	099126	4040,- 169,-	099133	4440,- 185,-	099140
koule / klika R	Kč €	5070,- 212,-	099157	5070,- 212,-	099164	5070,- 212,-	099171	5070,- 212,-	099188	5580,- 233,-	099195
koule / klika L	Kč €	5070,- 212,-	099201	5070,- 212,-	099218	5070,- 212,-	099225	5070,- 212,-	099232	5580,- 233,-	099249



Cr lesklý chrom

**Burak**

2220,- Kč  
93,- EUR

**Kč** materiál: masivní mosaz  
povrch: Cr lesklý chrom **EUR**

2220,-		93,-
3100,-		130,-
3100,-		130,-



Cr-K černý chrom natural

**Burak**

3520,- Kč  
147,- EUR

**Kč** materiál: masivní mosaz  
povrch: Cr-K černý chrom natural **EUR**

3520,-		147,-
4650,-		194,-
4650,-		194,-



SNi matný nikl

**Andy**

2060,- Kč  
86,- EUR

**Kč** materiál: masivní mosaz  
povrch: SNi matný nikl **EUR**

2060,-		86,-
2930,-		123,-
2930,-		123,-



TiN-A titan mosaz mat

**Andy**

3390,- Kč  
142,- EUR

**Kč** materiál: masivní mosaz  
povrch: TiN-A titan mosaz mat **EUR**

3390,-		142,-
4400,-		184,-
4400,-		184,-

Protipožární provedení (kovové podrozety + nerezové spojovací prvky, čtyřhran) ... příplatek 520,- Kč ... EAN 082289  
Pro případ požadavku panikové funkce je třeba objednat variantu z kategorie dveřní kliky DESIGN 2000, 2004 str. 72 – 82.  
Dále je třeba objednat dělený čtyřhran a specifikovat přesnou délku čtyřhranu str. 369. Magnetické rozety se s panikovou funkcí nedodávají.



Magnetická rozeta											
		SNI		Cr		Ms		Ms-L		Ms-A	
		cena / pár	EAN	cena / pár	EAN	cena / pár	EAN	cena / pár	EAN	cena / pár	EAN
klika / klika	Kč €	1880,- 79,-	097757	2220,- 93,-	097764	2510,- 105,-	097771	2510,- 105,-	097788	2640,- 110,-	097795
koule / klika R	Kč €	2750,- 115,-	097801	3100,- 130,-	097818	3390,- 142,-	097825	3390,- 142,-	097832	3510,- 147,-	097849
koule / klika L	Kč €	2750,- 115,-	097856	3100,- 130,-	097863	3390,- 142,-	097870	3390,- 142,-	097887	3510,- 147,-	097894

U povrchů Ms, Ms-L, Ms-A je vždy rozeta pod klikou, spodní zámkové rozety, WC mechanismus v matném „zlatém provedení“ tj. povrch TiN-A.

Magnetická rozeta											
		TiN-A		TiN-C		TiN-B		TiN-K		Cr-K	
		cena / pár	EAN	cena / pár	EAN	cena / pár	EAN	cena / pár	EAN	cena / pár	EAN
klika / klika	Kč €	3210,- 134,-	097900	3210,- 134,-	097917	3210,- 134,-	097924	3210,- 134,-	097931	3520,- 147,-	097948
koule / klika R	Kč €	4230,- 177,-	097955	4230,- 177,-	097962	4230,- 177,-	097979	4230,- 177,-	097986	4650,- 194,-	097993
koule / klika L	Kč €	4230,- 177,-	098006	4230,- 177,-	098013	4230,- 177,-	098020	4230,- 177,-	098037	4650,- 194,-	098044



Magnetická rozeta											
		SNI		Cr		Ms		Ms-L		Ms-A	
		cena / pár	EAN	cena / pár	EAN	cena / pár	EAN	cena / pár	EAN	cena / pár	EAN
klika / klika	Kč €	2060,- 86,-	098051	2400,- 100,-	098068	2670,- 112,-	098075	2670,- 112,-	098082	2810,- 118,-	098099
koule / klika R	Kč €	2930,- 123,-	098105	3250,- 136,-	098112	3520,- 147,-	098129	3520,- 147,-	098136	3660,- 153,-	098143
koule / klika L	Kč €	2930,- 123,-	098150	3250,- 136,-	098167	3520,- 147,-	098174	3520,- 147,-	098181	3660,- 153,-	098198

U povrchů Ms, Ms-L, Ms-A je vždy rozeta pod klikou, spodní zámkové rozety, WC mechanismus v matném „zlatém provedení“ tj. povrch TiN-A.

Magnetická rozeta											
		TiN-A		TiN-C		TiN-B		TiN-K		Cr-K	
		cena / pár	EAN	cena / pár	EAN	cena / pár	EAN	cena / pár	EAN	cena / pár	EAN
klika / klika	Kč €	3390,- 142,-	098204	3390,- 142,-	098211	3390,- 142,-	098228	3390,- 142,-	098235	3710,- 155,-	098242
koule / klika R	Kč €	4400,- 184,-	098259	4400,- 184,-	098266	4400,- 184,-	098273	4400,- 184,-	098280	4850,- 203,-	098297
koule / klika L	Kč €	4400,- 184,-	098303	4400,- 184,-	098310	4400,- 184,-	098327	4400,- 184,-	098334	4850,- 203,-	098341



Ms-A mosaz antik

**Sogut**

2930,- Kč  
123,- EUR

**Kč** materiál: masivní mosaz  
povrch: Ms-A mosaz antik **EUR**

2930,-		123,-
3820,-		160,-
3820,-		160,-



Cr-K černý chrom natural

**Sogut**

3840,- Kč  
160,- EUR

**Kč** materiál: masivní mosaz  
povrch: Cr-K černý chrom natural **EUR**

3840,-		160,-
4990,-		208,-
4990,-		208,-



SNi matný nikel

**Cherez**

2670,- Kč  
112,- EUR

**Kč** materiál: masivní mosaz  
povrch: SNi matný nikel **EUR**

2670,-		112,-
3840,-		160,-
3840,-		160,-



TiN-A titan mosaz mat

**Cherez**

3980,- Kč  
166,- EUR

**Kč** materiál: masivní mosaz  
povrch: TiN-A titan mosaz mat **EUR**

3980,-		166,-
5320,-		222,-
5320,-		222,-

Protipožární provedení (kovové podrozety + nerezové spojovací prvky, čtyřhran) ... příplatek 520,- Kč ... EAN 082289  
Pro případ požadavku panikové funkce je třeba objednat variantu z kategorie dveřní kliky DESIGN 2000, 2004 str. 72 – 82.  
Dále je třeba objednat dělený čtyřhran a specifikovat přesnou délku čtyřhranu str. 369. Magnetické rozety se s panikovou funkcí nedodávají.



Magnetická rozeta											
		SNI		Cr		Ms		Ms-L		Ms-A	
		cena / pár	EAN	cena / pár	EAN	cena / pár	EAN	cena / pár	EAN	cena / pár	EAN
klika / klika	Kč €	2180,- 91,-	098358	2510,- 105,-	098365	2770,- 116,-	098372	2770,- 116,-	098389	2930,- 123,-	098396
koule / klika R	Kč €	3060,- 128,-	098402	3400,- 142,-	098419	3660,- 153,-	098426	3660,- 153,-	098433	3820,- 160,-	098440
koule / klika L	Kč €	3060,- 128,-	098457	3400,- 142,-	098464	3660,- 153,-	098471	3660,- 153,-	098488	3820,- 160,-	098495

U povrchů Ms, Ms-L, Ms-A je vždy rozeta pod klikou, spodní zámkové rozety, WC mechanismus v matném „zlatém provedení“ tj. povrch TiN-A.

Magnetická rozeta											
		TiN-A		TiN-C		TiN-B		TiN-K		Cr-K	
		cena / pár	EAN	cena / pár	EAN	cena / pár	EAN	cena / pár	EAN	cena / pár	EAN
klika / klika	Kč €	3490,- 146,-	098501	3490,- 146,-	098518	3490,- 146,-	098525	3490,- 146,-	098532	3840,- 160,-	098549
koule / klika R	Kč €	4530,- 189,-	098556	4530,- 189,-	098563	4530,- 189,-	098570	4530,- 189,-	098587	4990,- 208,-	098594
koule / klika L	Kč €	4530,- 189,-	098600	4530,- 189,-	098617	4530,- 189,-	098624	4530,- 189,-	098631	4990,- 208,-	098648



Magnetická rozeta											
		SNI		Cr		Ms		Ms-L		Ms-A	
		cena / pár	EAN	cena / pár	EAN	cena / pár	EAN	cena / pár	EAN	cena / pár	EAN
klika / klika	Kč €	2670,- 112,-	098655	2990,- 125,-	098662	3270,- 137,-	098679	3270,- 137,-	098686	3420,- 143,-	098693
koule / klika R	Kč €	3840,- 160,-	098709	4160,- 174,-	098716	3660,- 153,-	098723	4440,- 185,-	098730	4590,- 192,-	098747
koule / klika L	Kč €	3840,- 160,-	098754	4160,- 174,-	098761	3660,- 153,-	098778	4440,- 185,-	098785	4590,- 192,-	098792

U povrchů Ms, Ms-L, Ms-A je vždy rozeta pod klikou, spodní zámkové rozety, WC mechanismus v matném „zlatém provedení“ tj. povrch TiN-A.

Magnetická rozeta											
		TiN-A		TiN-C		TiN-B		TiN-K		Cr-K	
		cena / pár	EAN	cena / pár	EAN	cena / pár	EAN	cena / pár	EAN	cena / pár	EAN
klika / klika	Kč €	3980,- 166,-	098808	3980,- 166,-	098815	3980,- 166,-	098822	3980,- 166,-	098839	4390,- 183,-	098846
koule / klika R	Kč €	5320,- 222,-	098853	5320,- 222,-	098860	5320,- 222,-	098877	5320,- 222,-	098884	5860,- 245,-	098891
koule / klika L	Kč €	5320,- 222,-	098907	5320,- 222,-	098914	5320,- 222,-	098921	5320,- 222,-	098938	5860,- 245,-	098945



Cr lesklý chrom

**Deny**

2220,- Kč  
93,- EUR

**Kč** materiál: masivní mosaz povrch: Cr lesklý chrom **EUR**

2220,-		93,-
3100,-		130,-
3100,-		130,-



TiN-K titan černý mat

**Deny**

3210,- Kč  
134,- EUR

**Kč** materiál: masivní mosaz povrch: TiN-K titan černý mat **EUR**

3210,-		134,-
4230,-		177,-
4230,-		177,-



SNi matný nikl

**Lusy**

1880,- Kč  
79,- EUR

**Kč** materiál: masivní mosaz povrch: SNi matný nikl **EUR**

1880,-		79,-
2750,-		115,-
2750,-		115,-



TiN-A titan mosaz mat

**Lusy**

3210,- Kč  
134,- EUR

**Kč** materiál: masivní mosaz povrch: TiN-A titan mosaz mat **EUR**

3210,-		134,-
4230,-		177,-
4230,-		177,-

Protipožární provedení (kovové podrozety + nerezové spojovací prvky, čtyřhran) ... příplatek 520,- Kč ... EAN 082289  
Pro případ požadavku panikové funkce je třeba objednat variantu z kategorie dveřní kliky DESIGN 2000, 2004 str. 72 – 82.  
Dále je třeba objednat dělený čtyřhran a specifikovat přesnou délku čtyřhranu str. 369. Magnetické rozety se s panikovou funkcí nedodávají.





Magnetická rozeta											
		SNI		Cr		Ms		Ms-L		Ms-A	
		cena / pár	EAN	cena / pár	EAN	cena / pár	EAN	cena / pár	EAN	cena / pár	EAN
klika / klika	Kč €	1880,- 79,-	099553	2220,- 93,-	099560	2510,- 105,-	099577	2510,- 105,-	099584	2640,- 110,-	099591
koule / klika R	Kč €	2750,- 115,-	099607	3100,- 130,-	099614	3390,- 142,-	099621	3390,- 142,-	099638	3510,- 147,-	099645
koule / klika L	Kč €	2750,- 115,-	099652	3100,- 130,-	099669	3390,- 142,-	099676	3390,- 142,-	099683	3510,- 147,-	099690

U povrchů Ms, Ms-L, Ms-A je vždy rozeta pod klikou, spodní zámkové rozety, WC mechanismus v matném „zlatém provedení“ tj. povrch TiN-A.

Magnetická rozeta											
		TiN-A		TiN-C		TiN-B		TiN-K		Cr-K	
		cena / pár	EAN	cena / pár	EAN	cena / pár	EAN	cena / pár	EAN	cena / pár	EAN
klika / klika	Kč €	3210,- 134,-	099706	3210,- 134,-	099713	3210,- 134,-	099720	3210,- 134,-	099737	3520,- 147,-	099744
koule / klika R	Kč €	4230,- 177,-	099751	4230,- 177,-	099768	4230,- 177,-	099775	4230,- 177,-	099782	4650,- 194,-	099799
koule / klika L	Kč €	4230,- 177,-	099805	4230,- 177,-	099812	4230,- 177,-	099829	4230,- 177,-	099836	4650,- 194,-	099843



Magnetická rozeta											
		SNI		Cr		Ms		Ms-L		Ms-A	
		cena / pár	EAN	cena / pár	EAN	cena / pár	EAN	cena / pár	EAN	cena / pár	EAN
klika / klika	Kč €	1880,- 79,-	095289	2220,- 93,-	095296	2510,- 105,-	101058	2510,- 105,-	101065	2640,- 110,-	101072
koule / klika R	Kč €	2750,- 115,-	095340	3100,- 130,-	095357	3390,- 142,-	101089	3390,- 142,-	101096	3510,- 147,-	101102
koule / klika L	Kč €	2750,- 115,-	095401	3100,- 130,-	095418	3390,- 142,-	101119	3390,- 142,-	101126	3510,- 147,-	101133

U povrchů Ms, Ms-L, Ms-A je vždy rozeta pod klikou, spodní zámkové rozety, WC mechanismus v matném „zlatém provedení“ tj. povrch TiN-A.

Magnetická rozeta											
		TiN-A		TiN-C		TiN-B		TiN-K		Cr-K	
		cena / pár	EAN	cena / pár	EAN	cena / pár	EAN	cena / pár	EAN	cena / pár	EAN
klika / klika	Kč €	3210,- 134,-	095302	3210,- 134,-	095319	3210,- 134,-	095326	3210,- 134,-	095333	3520,- 147,-	101232
koule / klika R	Kč €	4230,- 177,-	095364	4230,- 177,-	095371	4230,- 177,-	095388	4230,- 177,-	095395	4650,- 194,-	101249
koule / klika L	Kč €	4230,- 177,-	095425	4230,- 177,-	095432	4230,- 177,-	095449	4230,- 177,-	095456	4650,- 194,-	101256



SNi matný nikel

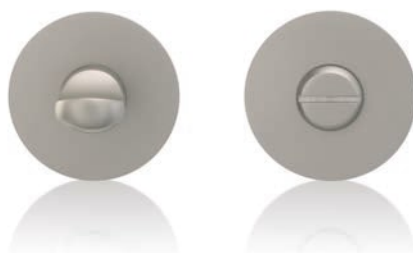

**Spodní rozety**

720,- Kč  
30,- EUR

materiál: magnetická nerez ocel  
Kč povrch: SNi matný nikel EUR

Kč		EUR
720,-	ⓘ	30,-
720,-	Ⓜ	30,-
1210,-	ⓔ	51,-
850,-	●	36,-

**Spodní rozety**

1340,- Kč  
56,- EUR

materiál: magnetická nerez ocel  
Kč povrch: TiN-C titan chrom mat EUR

Kč		EUR
1340,-	ⓘ	56,-
1340,-	Ⓜ	56,-
1980,-	ⓔ	83,-
1490,-	●	63,-



		<b>Magnetická rozeta</b>							
		<b>SNi</b>		<b>K-industrial</b>		<b>Cr</b>		<b>TiN-A</b>	
		cena / pár	EAN	cena / pár	EAN	cena / pár	EAN	cena / pár	EAN
dozické	Kč €	720,- 30,-	095647	1340,- 45,-	140255	840,- 35,-	095654	1340,- 56,-	095661
cyklindrické	Kč €	720,- 30,-	095708	1340,- 45,-	140262	840,- 35,-	095715	1340,- 56,-	095722
WC	Kč €	1210,- 51,-	095760	1980,- 65,-	140279	1430,- 60,-	095777	1980,- 83,-	095784
zaslepovací	Kč €	850,- 36,-	101140	1490,- 63,-	140286	980,- 41,-	101157	1490,- 63,-	104899

Spodní rozety v matném „zlatém provedení“ TiN-A se dodávají ke klikám v povrchu Ms-A, Ms-L, Ms.

		<b>Magnetická rozeta</b>							
		<b>TiN-C</b>		<b>TiN-B</b>		<b>TiN-K</b>		<b>Cr-K</b>	
		cena / pár	EAN	cena / pár	EAN	cena / pár	EAN	cena / pár	EAN
dozické	Kč €	1340,- 56,-	095678	1340,- 56,-	095685	1340,- 56,-	091601	1340,- 56,-	101263
cyklindrické	Kč €	1340,- 56,-	095739	1340,- 56,-	095746	1340,- 56,-	091618	1340,- 56,-	101270
WC	Kč €	1980,- 83,-	095791	1980,- 83,-	095807	1980,- 83,-	091625	1980,- 83,-	101287
zaslepovací	Kč €	1490,- 63,-	104905	1490,- 63,-	104882	1490,- 63,-	104875	1490,- 63,-	101164





SNi matný nikel

**Lusy**

2340,- Kč  
98,- EUR

Kč	materiál: masivní mosaz povrch: SNi matný nikel	EUR
2340,-		98,-
3500,-		146,-
3500,-		146,-



TiN-K titan černý mat

**Lusy**

3650,- Kč  
153,- EUR

Kč	materiál: masivní mosaz povrch: TiN-K titan černý mat	EUR
3650,-		153,-
4990,-		208,-
4990,-		208,-



Cr lesklý chrom

**Deny**

2670,- Kč  
112,- EUR

Kč	materiál: masivní mosaz povrch: Cr lesklý chrom	EUR
2670,-		112,-
3840,-		160,-
3840,-		160,-



TiN-K titan černý mat

**Deny**

3650,- Kč  
153,- EUR

Kč	materiál: masivní mosaz povrch: TiN-K titan černý mat	EUR
3650,-		153,-
4990,-		208,-
4990,-		208,-



Magnetická rozeta											
		SNI		Cr		Ms		Ms-L		Ms-A	
		cena / pár	EAN	cena / pár	EAN	cena / pár	EAN	cena / pár	EAN	cena / pár	EAN
klika / klika	Kč €	2340,- 98,-	095463	2670,- 112,-	095470	2950,- 123,-	101294	2950,- 123,-	101300	3100,- 130,-	101317
madlo / klika R	Kč €	3500,- 146,-	095524	3840,- 160,-	095531	4130,- 173,-	101324	4130,- 173,-	101331	4280,- 179,-	101348
madlo / klika L	Kč €	3500,- 146,-	095586	3840,- 160,-	095593	4130,- 173,-	101355	4130,- 173,-	101362	4280,- 179,-	101379

U povrchů Ms, Ms-L, Ms-A je vždy rozeta pod klikou a spodní rozety + WC mechanismus v matném „zlatém provedení“ tj. povrch TiN-A.

Magnetická rozeta											
		TiN-A		TiN-C		TiN-B		TiN-K		Cr-K	
		cena / pár	EAN	cena / pár	EAN	cena / pár	EAN	cena / pár	EAN	cena / pár	EAN
klika / klika	Kč €	3650,- 153,-	095487	3650,- 153,-	095494	3650,- 153,-	095500	3650,- 153,-	095517	4030,- 168,-	101478
madlo / klika R	Kč €	4990,- 208,-	095548	4990,- 208,-	095555	4990,- 208,-	095562	4990,- 208,-	095579	5500,- 230,-	101485
madlo / klika L	Kč €	4990,- 208,-	095609	4990,- 208,-	095616	4990,- 208,-	095623	4990,- 208,-	095630	5500,- 230,-	101492



Magnetická rozeta											
		SNI		Cr		Ms		Ms-L		Ms-A	
		cena / pár	EAN	cena / pár	EAN	cena / pár	EAN	cena / pár	EAN	cena / pár	EAN
klika / klika	Kč €	2340,- 98,-	100150	2670,- 112,-	100167	2950,- 123,-	100174	2950,- 123,-	100181	3100,- 130,-	100198
madlo / klika R	Kč €	3500,- 146,-	100204	3840,- 160,-	100211	4130,- 173,-	100228	4130,- 173,-	100235	4280,- 179,-	100242
madlo / klika L	Kč €	3500,- 146,-	100259	3840,- 160,-	100266	4130,- 173,-	100273	4130,- 173,-	100280	4280,- 179,-	100297

U povrchů Ms, Ms-L, Ms-A je vždy rozeta pod klikou a spodní rozety + WC mechanismus v matném „zlatém provedení“ tj. povrch TiN-A.

Magnetická rozeta											
		TiN-A		TiN-C		TiN-B		TiN-K		Cr-K	
		cena / pár	EAN	cena / pár	EAN	cena / pár	EAN	cena / pár	EAN	cena / pár	EAN
klika / klika	Kč €	3650,- 153,-	100303	3650,- 153,-	100310	3650,- 153,-	100327	3650,- 153,-	100334	4030,- 168,-	100341
madlo / klika R	Kč €	4990,- 208,-	100358	4990,- 208,-	100365	4990,- 208,-	100372	4990,- 208,-	100389	5500,- 230,-	100396
madlo / klika L	Kč €	4990,- 208,-	100402	4990,- 208,-	100419	4990,- 208,-	100426	4990,- 208,-	100433	5500,- 230,-	100440



SNi matný nikel

**Sogut**

2810,- Kč  
118,- EUR

Kč	materiál: masivní mosaz povrch: SNi matný nikel	EUR
2810,-		118,-
3950,-		165,-
3950,-		165,-



TiN-K titan černý mat

**Sogut**

4130,- Kč  
173,- EUR

Kč	materiál: masivní mosaz povrch: TiN-K titan černý mat	EUR
4130,-		173,-
5430,-		227,-
5430,-		227,-



Cr lesklý chrom

**Entero**

3690,- Kč  
154,- EUR

Kč	materiál: masivní mosaz povrch: Cr lesklý chrom	EUR
3690,-		154,-
4830,-		202,-
4830,-		202,-



TiN-K titan černý mat

**Entero**

4670,- Kč  
195,- EUR

Kč	materiál: masivní mosaz povrch: TiN-K titan černý mat	EUR
4670,-		195,-
5970,-		249,-
5970,-		249,-



Magnetická rozeta											
		SNI		Cr		Ms		Ms-L		Ms-A	
		cena / pár	EAN	cena / pár	EAN	cena / pár	EAN	cena / pár	EAN	cena / pár	EAN
klika / klika	Kč €	2810,- 118,-	100457	3140,- 131,-	100464	3420,- 143,-	100471	3420,- 143,-	100488	3570,- 149,-	100495
madlo / klika R	Kč €	3950,- 165,-	100501	4290,- 179,-	100518	4570,- 191,-	100525	4570,- 191,-	100532	4700,- 196,-	100549
madlo / klika L	Kč €	3950,- 165,-	100556	4290,- 179,-	100563	4570,- 191,-	100570	4570,- 191,-	100587	4700,- 196,-	100594

U povrchů Ms, Ms-L, Ms-A je vždy rozeta pod klikou a spodní rozety + WC mechanismus v matném „zlatém provedení“ tj. povrch TiN-A.

Magnetická rozeta											
		TiN-A		TiN-C		TiN-B		TiN-K		Cr-K	
		cena / pár	EAN	cena / pár	EAN	cena / pár	EAN	cena / pár	EAN	cena / pár	EAN
klika / klika	Kč €	4130,- 173,-	100600	4130,- 173,-	100617	4130,- 173,-	100624	4130,- 173,-	100631	4540,- 190,-	100648
madlo / klika R	Kč €	5430,- 227,-	100655	5430,- 227,-	100662	5430,- 227,-	100679	5430,- 227,-	100686	5980,- 250,-	100693
madlo / klika L	Kč €	5430,- 227,-	100709	5430,- 227,-	100716	5430,- 227,-	100723	5430,- 227,-	100730	5980,- 250,-	100747



Magnetická rozeta											
		SNI		Cr		Ms		Ms-L		Ms-A	
		cena / pár	EAN	cena / pár	EAN	cena / pár	EAN	cena / pár	EAN	cena / pár	EAN
klika / klika	Kč €	3370,- 141,-	100754	3690,- 154,-	100761	3960,- 165,-	100778	3960,- 165,-	100785	4110,- 172,-	100792
madlo / klika R	Kč €	4500,- 188,-	100808	4830,- 202,-	100815	5100,- 213,-	100822	5100,- 213,-	100839	5260,- 220,-	100846
madlo / klika L	Kč €	4500,- 188,-	100853	4830,- 202,-	100860	5100,- 213,-	100877	5100,- 213,-	100884	5260,- 220,-	100891

U povrchů Ms, Ms-L, Ms-A je vždy rozeta pod klikou a spodní rozety + WC mechanismus v matném „zlatém provedení“ tj. povrch TiN-A.

Magnetická rozeta											
		TiN-A		TiN-C		TiN-B		TiN-K		Cr-K	
		cena / pár	EAN	cena / pár	EAN	cena / pár	EAN	cena / pár	EAN	cena / pár	EAN
klika / klika	Kč €	4670,- 195,-	100907	4670,- 195,-	100914	4670,- 195,-	100921	4670,- 195,-	100938	5140,- 215,-	100945
madlo / klika R	Kč €	5970,- 249,-	100952	5970,- 249,-	100969	5970,- 249,-	100976	5970,- 249,-	100983	6580,- 275,-	100990
madlo / klika L	Kč €	5970,- 249,-	101003	5970,- 249,-	101010	5970,- 249,-	101027	5970,- 249,-	101034	6580,- 275,-	101041



SNi matný nikel



**Spodní rozety**

840,- Kč  
35,- EUR

materiál: magnetická nerez ocel  
Kč povrch: SNi matný nikel EUR

840,-		35,-
840,-		35,-
1400,-		59,-
980,-		41,-

**Spodní rozety**

1480,- Kč  
62,- EUR

materiál: magnetická nerez ocel  
Kč povrch: TiN-C titan chrom mat EUR

1480,-		62,-
1480,-		62,-
2180,-		91,-
1620,-		68,-





		Magnetická rozeta							
		SNI		K-industrial		Cr		TiN-A	
		cena / pár	EAN	cena / pár	EAN	cena / pár	EAN	cena / pár	EAN
dozické	Kč €	840,- 35,-	095821	1480,- 62,-	140293	990,- 42,-	095838	1480,- 62,-	095845
cylindrické	Kč €	840,- 35,-	095883	1480,- 62,-	140309	990,- 42,-	095890	1480,- 62,-	095906
WC	Kč €	1400,- 59,-	095944	2180,- 91,-	140316	1650,- 69,-	095951	2180,- 91,-	095968
zaslepovací	Kč €	980,- 41,-	101171	1620,- 68,-	140323	1140,- 48,-	101188	1620,- 68,-	105070

Spodní rozety v matném „zlatém provedení“ TiN-A se dodávají ke klikám v povrchu Ms-A, Ms-L, Ms.

		Magnetická rozeta							
		TiN-C		TiN-B		TiN-K		Cr-K	
		cena / pár	EAN	cena / pár	EAN	cena / pár	EAN	cena / pár	EAN
dozické	Kč €	1480,- 62,-	095852	1480,- 62,-	095869	1480,- 62,-	093582	1480,- 62,-	101508
cylindrické	Kč €	1480,- 62,-	095913	1480,- 62,-	095920	1480,- 62,-	093599	1480,- 62,-	101515
WC	Kč €	2180,- 91,-	095975	2180,- 91,-	095982	2180,- 91,-	093605	2180,- 91,-	101522
zaslepovací	Kč €	1620,- 68,-	105087	1620,- 68,-	105063	1620,- 68,-	105056	1620,- 68,-	101195



vrtání otvorů  
pro magnetické rozety

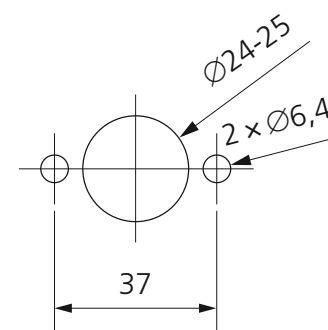



Celý projekt - jeden design

Dveřní kliky, madla



Kliky a zámky na skleněné dveře



Kliky a madla pro hliníkové a ocelové dveře



Panty na skleněné dveře



Bezpečnostní rozety



Okenní kliky 3-polohové



Dlouhá madla



Dveřní kliky DESIGN 2018 **Rocksor**

Materiál: masivní mosaz 

Povrchy: Ms-A, Ms-K, Ms-L, TiN-C, TiN-K, K-industrial  
více info na [www.kliky-mt.cz/manufaktura/barvy-povrchy](http://www.kliky-mt.cz/manufaktura/barvy-povrchy)

Konstrukce, mechanika: magnetické rozety, mechanika M2018



ROCKSOR **TiN-K** titan černý mat



ROCKSOR **Ms-A** mosaz antik



Klika/klika + magnetické rozety



Madlo/klika R + magnetické rozety



Madlo/klika L + magnetické rozety



Rozety dozické



Rozety cylindrické



Rozety WC



Rozety zaslepovací



dozické



cylindrické



zaslepovací



WC ex



WC in



madlo Rocksor

magnetické rozety Ø 54 mm, tl. 5 mm

konstrukční varianty, materiálové provedení

- designová sada standardně bez spodních rozet
- spodní rozety se objednávají samostatně
- konstrukční systém s vratnou pružinou u kliky
- montáž sešroubování pouzdry proti sobě
- další fixace pomocí 2 vrtutů
- rukojeti vyrobeny z masivní mosazi
- rozety vyrobeny z magnetické nerez oceli
- zajišťovací gel proti uvolnění šroubů
- vrtání PROFÍ šablonou M&T vrtákem Ø 6,4 mm
- montáž pro tloušťky dveří 38 – 126 mm
- v balení standardně montážní materiál pro tl. dveří 38 - 45 mm
- záruka 5 let, titany 15 let, rukojeti z masivní mosazi - doživotní záruka

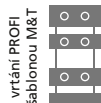

Ochranná známka – registrovaná značka

**ROCKSOR®**

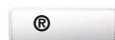

Chráněné průmyslové vzory klik

**ROCKSOR**



5 let garance

15 let garance



Ms-L mosaz leštěná  
(celá rukojeť vyleštěná)

**Klika Rocksor**  
magnetická rozeta Ø54x5 mm

2170,- Kč  
91,- EUR



TiN-K titan černý mat



Ms-A mosaz antik  
(obroušené, ohlazené výstupky na rukojeti pro vzhled „používané kliky“)

materiál: masivní mosaz  
povrch: Ms-K mosaz natur

Kč		EUR
2170,-		91,-
3650,-		153,-
2810,-		118,-
2810,-		118,-



Ms-A mosaz antik  
(obroušené, ohlazené výstupky na rukojeti pro vzhled „používané kliky“)

**Klika Rocksor U**  
magnetická rozeta Ø54x5 mm

2400,- Kč  
100,- EUR



Ms-A mosaz antik

materiál: masivní mosaz  
povrch: Ms-K mosaz natur

Kč		EUR
2400,-		100,-
3160,-		132,-
3160,-		132,-



**Spodní rozety**

1340,- Kč  
56,- EUR

materiál: magnetická nerez ocel  
povrch: TiN-A titan mosaz mat

Kč		EUR
1340,-		56,-
1340,-		56,-
1980,-		83,-
1490,-		63,-

Protipožární provedení (kovové podrozety + nerezové spojovací prvky, čtyřhran) ... příplatek 520,- Kč ... EAN 082289.  
Provedení panikové pro zámky s děleným čtyřhranem nelze dodat na magnetických rozetách. Lze dodat na rozetách pro Al profily, nebo na kulatých rozetách DESIGN 2000. Dělený čtyřhran se objednává zvlášť a je třeba specifikovat přesnou délku čtyřhranu, str. 369.



		Ms-K		Ms-A		Ms-L		TiN-C		TiN-K		K-industrial	
		cena	EAN	cena	EAN	cena	EAN	cena	EAN	cena	EAN	cena	EAN
		pár		pár		pár		pár		pár		pár	
klika / klika	Kč €	2170,- 91,-	082180	2400,- 100,-	082098	2400,- 100,-	087314	3400,- 142,-	094619	3400,- 142,-	094664	3400,- 142,-	137774
madlo / madlo	Kč €	3650,- 153,-	107425	3880,- 162,-	107432	3880,- 162,-	107449	5020,- 210,-	107456	5020,- 210,-	107463	5020,- 210,-	137903
madlo / klika L	Kč €	2810,- 118,-	082210	3040,- 127,-	082043	3040,- 127,-	087345	4160,- 174,-	094640	4160,- 174,-	094695	4160,- 174,-	137781
madlo / klika R	Kč €	2810,- 118,-	082227	3040,- 127,-	082050	3040,- 127,-	087352	4160,- 174,-	094657	4160,- 174,-	094701	4160,- 174,-	137798

U povrchů Ms-A, Ms-L, Ms-K je vždy rozeta pod klikou, spodní zámkové rozety, WC mechanismus v matném „zlatém provedení“ TiN-A.



**Ms-K** mosaz natur  
(celá rukojet v naturální mosazi  
z kovářny, pouze zabroušené ostré hrany)



**TiN-C** titan chrom mat



		Ms-K		Ms-A		Ms-L		TiN-C		TiN-K		K-industrial	
		cena	EAN	cena	EAN	cena	EAN	cena	EAN	cena	EAN	cena	EAN
		pár		pár		pár		pár		pár		pár	
klika / klika	Kč €	2400,- 100,-	082265	2590,- 108,-	082104	2590,- 108,-	087406	3660,- 153,-	094794	3660,- 153,-	094848	3660,- 153,-	137804
madlo / klika L	Kč €	3160,- 132,-	082296	3370,- 141,-	082135	3370,- 141,-	087437	4440,- 185,-	094824	4440,- 185,-	094879	4440,- 185,-	137811
madlo / klika R	Kč €	3160,- 132,-	082302	3370,- 141,-	082142	3370,- 141,-	087444	4440,- 185,-	094831	4440,- 185,-	094886	4440,- 185,-	137828

U povrchů Ms-A, Ms-L, Ms-K je vždy rozeta pod klikou, spodní zámkové rozety, WC mechanismus v matném „zlatém provedení“ TiN-A.

		Magnetická rozeta							
		TiN-A		TiN-C		TiN-K		K-industrial	
		cena / pár	EAN	cena / pár	EAN	cena / pár	EAN	cena / pár	EAN
dozické	Kč €	1340,- 56,-	095661	1340,- 56,-	095678	1340,- 56,-	091601	1340,- 56,-	140255
cyklindrické	Kč €	1340,- 56,-	095722	1340,- 56,-	095739	1340,- 56,-	091618	1340,- 56,-	140262
WC	Kč €	1980,- 83,-	095784	1980,- 83,-	095791	1980,- 83,-	091625	1980,- 83,-	140279
plná/zaslepovací	Kč €	1490,- 63,-	104899	1490,- 63,-	104905	1490,- 63,-	104875	1490,- 63,-	140286

Spodní rozety v matném „zlatém provedení“ TiN-A se dodávají ke klikám v povrchu Ms-A, Ms-L, Ms-K.



**Ms-A** mosaz antik  
(obroušené, ohlazené výstupky  
na rukojeti pro vzhled „používané kliky“)

**Klika na sklo**

1740,- Kč  
1810,- EUR

materiál: masivní mosaz  
povrch: Ms-K mosaz natur

**Kč**  **EUR**

1740,-  73,-

1810,-  76,-



**Ms-A** mosaz antik

**Zámek na sklo Entero**

6980,- Kč  
291,- EUR

materiál: masivní mosaz  
povrch: Ms-K mosaz natur

**Kč**  **EUR**

6980,-  291,-

7060,-  295,-

8050,-  336,-

8200,-  342,-



**Ms-A** mosaz antik

**Pant Entero**

6110,- Kč  
255,- EUR

materiál: masivní mosaz  
povrch: Ms-K mosaz natur

**Kč**  **EUR**

6110,-  255,-



**Ms-A** mosaz antik  
(obroušené, ohlazené výstupky  
na rukojeti pro vzhled „používané kliky“)

**Madlo dlouhé Rocksor**

7700,- Kč  
321,- EUR

materiál: masivní mosaz  
povrch: Ms-K mosaz natur

**Kč**  **EUR**

7700,-  321,-

3850,-  161,-



		Ms-K		Ms-A		Ms-L		TiN-C		TiN-K		K-industrial	
		cena	EAN	cena	EAN	cena	EAN	cena	EAN	cena	EAN	cena	EAN
		pár		pár		pár		pár		pár		pár	
Rocksor	Kč €	1740,- 73,-	085556	1830,- 77,-	084573	1830,- 77,-	087499	2250,- 94,-	094978	2250,- 94,-	094992	2250,- 94,-	137835
Rocksor U	Kč €	1810,- 76,-	085570	1870,- 78,-	085563	1870,- 78,-	087505	2310,- 97,-	094985	2310,- 97,-	095005	2310,- 97,-	137842



		Ms-K		Ms-A		Ms-L		TiN-C		TiN-K		K-industrial	
		cena	EAN	cena	EAN	cena	EAN	cena	EAN	cena	EAN	cena	EAN
		pár		pár		pár		pár		pár		pár	
standard	Kč €	6980,- 291,-	095111	8680,- 362,-	084528	8680,- 362,-	087512	9870,- 412,-	87835	10280,- 429,-	87798	10280,- 429,-	137859
cyldrický	Kč €	7060,- 295,-	095128	8800,- 367,-	084535	8800,- 367,-	087529	9980,- 416,-	87842	10350,- 432,-	87804	10350,- 432,-	137866
WC	Kč €	8050,- 336,-	095135	9960,- 415,-	084542	9960,- 415,-	087536	11160,- 465,-	87859	11530,- 481,-	87811	11530,- 481,-	137873
protikus	Kč €	8200,- 342,-	095142	10160,- 424,-	084559	10160,- 424,-	087543	11470,- 478,-	87866	11850,- 494,-	87828	11850,- 494,-	137880

Uvedené ceny za zámky bez klik. Kliky/rukojeti se objednávají zvlášť a jsou uvedeny v tabulce výše.



		Ms-K		Ms-A		Ms-L		TiN-C		TiN-K		K-industrial	
		cena	EAN	cena	EAN	cena	EAN	cena	EAN	cena	EAN	cena	EAN
		pár		pár		pár		pár		pár		pár	
	Kč €	6110,- 255,-	095241	6390,- 267,-	095234	6000,- 250,-	095258	7080,- 295,-	88207	7420,- 310,-	88191	7420,- 310,-	137897

Součástí pantů a v ceně sady pantů je střední díl pantu a vložka závěsu.

		Ms-K		Ms-A		Ms-L		TiN-C		TiN-K	
		cena	EAN	cena	EAN	cena	EAN	cena	EAN	cena	EAN
rozteč 300 mm oboustranné	Kč €	pár 7700,- 321,-	101546	pár 7860,- 328,-	101539	pár 7860,- 328,-	101553	pár 9460,- 395,-	101560	pár 9460,- 395,-	101577
rozteč 300 mm jednostranné	Kč €	ks 3850,- 161,-	101591	ks 3930,- 164,-	101584	ks 3930,- 164,-	101607	ks 4730,- 197,-	101614	ks 4730,- 197,-	101621

Montážní materiál pro madla	cena	EAN	Montážní materiál pro madla	cena	EAN
jednostranné do slepé díry - plast	Kč €	280,- 11,7	030204	280,- 11,7	003024
jednostranné do slepé díry - hliník	Kč €	280,- 11,7	030211	370,- 15,4	003031
jednostranné do slepé díry - dřevo	Kč €	280,- 11,7	030228	280,- 11,7	003048
	Kč €	370,- 15,4	003055	370,- 15,4	003055

Ceny modelů jsou uvedeny bez montážního materiálu. Montážní materiál je nutno specifikovat podle materiálu dveří.



**Ms-K mosaz natur**  
(celá rukojeť v naturální mosazi  
z kovářny, pouze zabroušené ostré hrany)

**Klika Rocksor  
pro Al profily**

3040,- Kč  
127,- EUR

Kč	materiál: masivní mosaz povrch: Ms-K mosaz natur	EUR
3040,-		127,-
3830,-		160,-
3830,-		160,-
940,-		40,-



**Ms-A mosaz antik**  
(obroušené, ohlazené výstupky  
na rukojeti pro vzhled „používané kliky“)

**Klika Rocksor U  
pro Al profily**

3220,- Kč  
135,- EUR

Kč	materiál: masivní mosaz povrch: Ms-K mosaz natur	EUR
3220,-		135,-
4000,-		167,-
4000,-		167,-
940,-		40,-



**Ms-A mosaz antik**



**Ms-A mosaz antik**



**Ms-K mosaz natur**  
(celá rukojeť v naturální mosazi  
z kovářny, pouze zabroušené ostré  
hrany)

**Okenní klika**

1470,- Kč  
62,- EUR

Kč	materiál: masivní mosaz povrch: Ms-K mosaz natur	EUR
1470,-		62,-
1620,-		68,-



**Ms-A mosaz antik**  
(obroušené, ohlazené výstupky  
na rukojeti pro vzhled „používané kliky“)

**Madlo dlouhé Rocksor**

7700,- Kč  
321,- EUR

Kč	materiál: masivní mosaz povrch: Ms-K mosaz natur	EUR
7700,-		321,-
3850,-		161,-





		Ms-K		Ms-A		Ms-L		TiN-C		TiN-K		K-industrial	
		cena	EAN	cena	EAN	cena	EAN	cena	EAN	cena	EAN	cena	EAN
		pár		pár		pár		pár		pár		pár	
klika / klika	Kč €	3040,- 127,-	082234	3260,- 136,-	082067	3260,- 136,-	087369	4390,- 183,-	094718	4390,- 183,-	094756	4390,- 183,-	137910
madlo / klika L	Kč €	3830,- 160,-	082241	4050,- 169,-	082074	4050,- 169,-	087376	5180,- 216,-	094725	5180,- 216,-	094763	5180,- 216,-	137927
madlo / klika R	Kč €	3830,- 160,-	082258	4050,- 169,-	082081	4050,- 169,-	087383	5180,- 216,-	094732	5180,- 216,-	094770	5180,- 216,-	137934
rozeta cylindrická 33x47 mm	Kč €	940,- 40,-	082708	990,- 42,-	082692	990,- 42,-	087390	1330,- 56,-	001983	1330,- 56,-	002676	1330,- 56,-	137941



		Ms-K		Ms-A		Ms-L		TiN-C		TiN-K		K-industrial	
		cena	EAN	cena	EAN	cena	EAN	cena	EAN	cena	EAN	cena	EAN
		pár		pár		pár		pár		pár		pár	
klika / klika	Kč €	3220,- 135,-	082319	3430,- 143,-	082159	3430,- 143,-	087451	4570,- 191,-	094893	4570,- 191,-	094930	4570,- 191,-	137958
madlo / klika L	Kč €	4000,- 167,-	082326	4210,- 176,-	082166	4210,- 176,-	087468	5350,- 223,-	094909	5350,- 223,-	094947	5350,- 223,-	137965
madlo / klika R	Kč €	4000,- 167,-	082333	4210,- 176,-	082173	4210,- 176,-	087475	5350,- 223,-	094916	5350,- 223,-	094954	5350,- 223,-	137972
rozeta cylindrická 33x47 mm	Kč €	940,- 40,-	082708	990,- 42,-	082692	990,- 42,-	087390	1330,- 56,-	001983	1330,- 56,-	002676	1330,- 56,-	137941



		Ms-K		Ms-A		Ms-L		TiN-C		TiN-K		K-industrial	
		cena	EAN	cena	EAN	cena	EAN	cena	EAN	cena	EAN	cena	EAN
		pár		pár		pár		pár		pár		pár	
Rocksor	Kč €	1470,- 62,-	095029	1570,- 66,-	095012	1570,- 66,-	095036	2140,- 90,-	095043	2140,- 90,-	095050	2140,- 90,-	137989
Rocksor U	Kč €	1620,- 68,-	095074	1730,- 73,-	095067	1730,- 73,-	095081	2290,- 96,-	095098	2290,- 96,-	095104		

Polohovací mechanismus s plochou oválnou rozetou je 3-polohový kovový a je součástí příslušenství okenní kličky. Lze zapustit do rámu okna. Oválná rozeta pod rukojetí je u povrchu Ms-A, Ms-K, Ms-L v matném „zlatém provedení“ TiN-A.

		Ms-K		Ms-A		Ms-L		TiN-C		TiN-K	
		cena	EAN	cena	EAN	cena	EAN	cena	EAN	cena	EAN
rozteč 300 mm oboustranné	Kč €	pár 7700,- 321,-	101546	pár 7860,- 436,-	101539	pár 7860,- 436,-	101553	pár 9460,- 525,-	101560	pár 9460,- 525,-	101577
rozteč 300 mm jednostranné	Kč €	ks 3850,- 161,-	101591	ks 3930,- 219,-	101584	ks 3930,- 219,-	101607	ks 4730,- 263,-	101614	ks 4730,- 263,-	101621

## klika ROCKSOR

design: Stanislav Fiala  
materiál: masivní mosaz  
mechanika: magnetická rozeta s vratnou pružinou



**vrtání otvorů  
pro magnetické rozety**

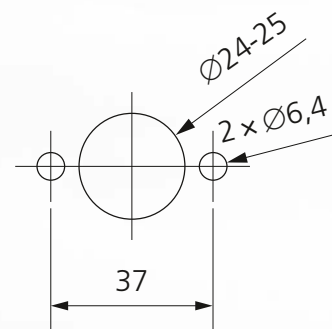





vrtání otvorů  
pro magnetické rozety

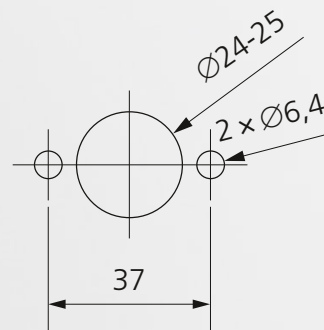

Celý projekt - jeden design

Dveřní kliky



Kliky a zámky na skleněné dveře



Kliky pro hliníkové a ocelové dveře



Panty na skleněné dveře



Bezpečnostní rozety



Okenní kliky 3-polohové



Madla dlouhá



Dveřní kliky DESIGN 2018 **Industry Squelette**

Materiál: **nerezová ocel**

Povrchy: **NRz, TiN-K, TiN-B, TiN-A, TiN-C, K-industrial**  
více info na [www.kliky-mt.cz/manufaktura/barvy-povrchy](http://www.kliky-mt.cz/manufaktura/barvy-povrchy)

Konstrukce, mechanika: **magnetické rozety, mechanika M2018**



**INDUSTRY SQUELETTE TiN-K** titan černý mat



- Klika/klika + magnetické rozety
- Madlo/klika R + magnetické rozety
- Madlo/klika L + magnetické rozety
- Rozety dozické
- Rozety cylindrické
- Rozety WC
- Rozety zaslepovací



dozické   cylindrické   zaslepovací   WC ex   WC in

magnetické rozety Ø 54 mm, tl. 5 mm

**INDUSTRY SQUELETTE NRz** nerez - broušeno

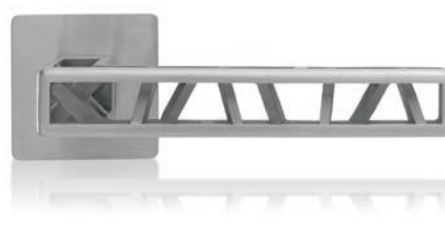

- Klika/klika + magnetické rozety
- Madlo/klika R + magnetické rozety
- Madlo/klika L + magnetické rozety
- Rozety dozické
- Rozety cylindrické
- Rozety WC
- Rozety zaslepovací



dozické   cylindrické   zaslepovací   WC ex   WC in

magnetické rozety 54x54 mm, tl. 5 mm

konstrukční varianty, materiálové provedení

- designová sada standardně bez spodních rozet
- spodní rozety se objednávají samostatně
- konstrukční systém s vratnou pružinou u kliky
- montáž sešroubování pouzdry proti sobě
- další fixace pomocí 2 vrtutů
- rukojeti vyrobeny z nerezové oceli
- rozety vyrobeny z magnetické nerez oceli
- zajišťovací gel proti uvolnění šroubů
- vrtání PROFÍ šablonou M&T vrtákem Ø 6,4 mm
- montáž pro tloušťky dveří 38 – 126 mm
- v balení standardně montážní materiál pro tl. dveří 38 - 45 mm
- záruka 5 let, titany 15 let

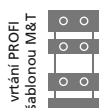

let **5 garance**   let **15 garance**

Ochranná známka – registrovaná značka **INDUSTRY®**

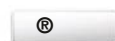

Chráněné průmyslové vzory klik **INDUSTRY**





TiN-K titan černý mat

**Industry Squelette**

2760,- Kč  
115,- EUR

materiál: nerezová ocel  
Kč povrch: NRz nerez - broušeno EUR

2760,-		115,-
4320,-		180,-
3480,-		145,-
3480,-		145,-



madlo

NRz nerez - broušeno



NRz nerez - broušeno

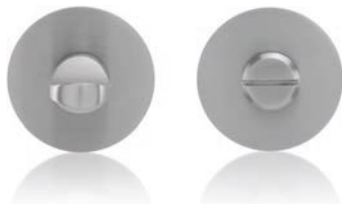

**Spodní rozety**

580,- Kč  
25,- EUR

materiál: magnetická nerez ocel  
Kč povrch: NRz nerez - broušeno EUR

580,-		25,-
580,-		25,-
1060,-		45,-
720,-		30,-

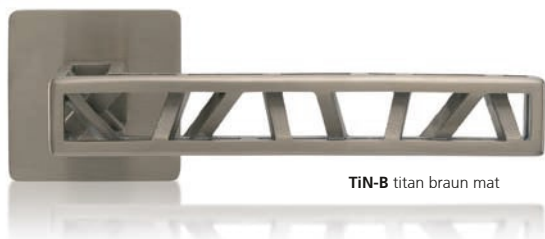

TiN-B titan braun mat

**Industry Squelette**

3090,- Kč  
129,- EUR

materiál: nerezová ocel  
Kč povrch: NRz nerez - broušeno EUR

3090,-		129,-
4630,-		193,-
3800,-		159,-
3800,-		159,-



TiN-K titan černý mat



**Spodní rozety**

690,- Kč  
29,- EUR

materiál: magnetická nerez ocel  
Kč povrch: NRz nerez - broušeno EUR

690,-		29,-
690,-		29,-
1270,-		53,-
840,-		35,-

Protipožární provedení (kovové podrozety + nerezové spojovací prvky, čtyřhran) ... příplatek 520,- Kč ... EAN 082289.  
Provedení panikové pro zámky s děleným čtyřhranem nelze dodat na magnetických rozetách. Lze dodat na rozetách pro Al profily. Dělený čtyřhran se objednává zvlášť a je třeba specifikovat přesnou délku čtyřhranu, str. 369.

		Magnetická rozeta											
		NRz		TiN-K		TiN-B		TiN-A		TiN-C		K-industrial	
		cena / pár	EAN	cena / pár	EAN	cena / pár	EAN	cena / pár	EAN	cena / pár	EAN	cena / pár	EAN
klika / klika	Kč €	2760,- 115,-	103472	3910,- 163,-	103533	4460,- 186,-	103564	4460,- 186,-	103595	4460,- 186,-	103625	3910,- 163,-	103502
madlo / madlo	Kč €	4320,- 180,-	107470	5460,- 228,-	107494	6160,- 257,-	107500	6160,- 257,-	107517	6160,- 257,-	107524	5460,- 228,-	107487
madlo / klika R	Kč €	3480,- 145,-	103489	4610,- 193,-	103540	5300,- 221,-	103571	5300,- 221,-	103601	5300,- 221,-	103632	4610,- 193,-	103519
madlo / klika L	Kč €	3480,- 145,-	103496	4610,- 193,-	103557	5300,- 221,-	103588	5300,- 221,-	103618	5300,- 221,-	103649	4610,- 193,-	103526

Spojovací čtyřhran 8 x 8 mm z nerez oceli se dodává ve stejném povrchu jako kliky a je součástí balení klik. Délka 95 mm pro dveře tl. 38 - 45 mm. Čtyřhrany pro tl. dveří od 46 mm nejsou součástí balení a objednávají se zvlášť, viz tabulka čtyřhranů na další stránce.



TiN-C titan chrom mat



TiN-A titan mosaz mat

		Magnetická rozeta											
		NRz		TiN-K		TiN-B		TiN-A		TiN-C		K-industrial	
		cena / pár	EAN	cena / pár	EAN	cena / pár	EAN	cena / pár	EAN	cena / pár	EAN	cena / pár	EAN
dozické	Kč €	580,- 25,-	091571	1340,- 56,-	091601	1340,- 56,-	095685	1340,- 56,-	095661	1340,- 56,-	095678	1340,- 56,-	140255
cyklindrické	Kč €	580,- 25,-	091588	1340,- 56,-	091618	1340,- 56,-	095746	1340,- 56,-	095722	1340,- 56,-	095739	1340,- 56,-	140262
WC	Kč €	1060,- 45,-	091595	1980,- 83,-	091625	1980,- 83,-	095807	1980,- 83,-	095784	1980,- 83,-	095791	1980,- 83,-	140279
plná/zaslepovací	Kč €	720,- 30,-	104851	1490,- 63,-	104875	1490,- 63,-	104882	1490,- 63,-	104899	1490,- 63,-	104905	1490,- 63,-	140286

		Magnetická rozeta											
		NRz		TiN-K		TiN-B		TiN-A		TiN-C		K-industrial	
		cena / pár	EAN	cena / pár	EAN	cena / pár	EAN	cena / pár	EAN	cena / pár	EAN	cena / pár	EAN
klika / klika	Kč €	3090,- 129,-	103656	4200,- 175,-	103717	4770,- 199,-	103748	4770,- 199,-	103779	4770,- 199,-	103809	4200,- 175,-	103687
madlo / madlo	Kč €	4630,- 193,-	107531	5760,- 240,-	107555	6470,- 270,-	107562	6470,- 270,-	107579	6470,- 270,-	107586	5760,- 240,-	107548
madlo / klika R	Kč €	3800,- 159,-	103663	4910,- 205,-	103724	5610,- 234,-	103755	5610,- 234,-	103786	5610,- 234,-	103816	4910,- 205,-	103694
madlo / klika L	Kč €	3800,- 159,-	103670	4910,- 205,-	103731	5610,- 234,-	103762	5610,- 234,-	103793	5610,- 234,-	103823	4910,- 205,-	103700

Spojovací čtyřhran 8 x 8 mm z nerez oceli se dodává ve stejném povrchu jako kliky a je součástí balení klik. Délka 95 mm pro dveře tl. 38 - 45 mm. Čtyřhrany pro tl. dveří od 46 mm nejsou součástí balení a objednávají se zvlášť, viz tabulka čtyřhranů na další stránce.

		Magnetická rozeta											
		NRz		TiN-K		TiN-B		TiN-A		TiN-C		K-industrial	
		cena / pár	EAN	cena / pár	EAN	cena / pár	EAN	cena / pár	EAN	cena / pár	EAN	cena / pár	EAN
dozické	Kč €	690,- 29,-	093551	1480,- 62,-	093582	1480,- 62,-	095869	1480,- 62,-	095845	1480,- 62,-	095852	1480,- 62,-	140293
cyklindrické	Kč €	690,- 29,-	093568	1480,- 62,-	093599	1480,- 62,-	095920	1480,- 62,-	095906	1480,- 62,-	095913	1480,- 62,-	140309
WC	Kč €	1270,- 53,-	093575	2180,- 91,-	093605	2180,- 91,-	095982	2180,- 91,-	095968	2180,- 91,-	095975	2180,- 91,-	140316
plná/zaslepovací	Kč €	840,- 35,-	105032	1620,- 68,-	105056	1620,- 68,-	105063	1620,- 68,-	105070	1620,- 68,-	105087	1620,- 68,-	140323



TiN-A titan mosaz mat



TiN-K titan černý mat



TiN-K titan černý mat



TiN-K titan černý mat



TiN-K titan černý mat

**Čtyřhran**

110,- Kč  
4,6 EUR

materiál: nerezová ocel  
povrch: NRz nerez - broušeno

Kč		EUR
110,-		4,6
140,-		5,9
160,-		6,7
170,-		7,1
200,-		8,4

**Klika na sklo**

2970,- Kč  
124,- EUR

materiál: nerezová ocel  
povrch: TiN-K titan černý mat

Kč		EUR
2970,-		124,-

**Zámek na sklo Entero**

10280,- Kč  
429,- EUR

materiál: masivní mosaz  
povrch: TiN-K titan černý mat

Kč		EUR
10280,-		429,-
10350,-		432,-
11530,-		481,-
11850,-		494,-

**Pant Entero**

7420,- Kč  
310,- EUR

materiál: masivní mosaz  
povrch: TiN-K titan černý mat

Kč		EUR
7420,-		310,-



		NRz		TiN-K		TiN-B		TiN-A		TiN-C	
		cena	EAN	cena	EAN	cena	EAN	cena	EAN	cena	EAN
délka čtyřhranu 105 mm pro tl. dveří 46 - 55 mm	Kč €	110,- 4,6	095876	330,- 14,-	093711	330,- 14,-	103908	330,- 14,-	104011	330,- 14,-	104608
délka čtyřhranu 115 mm pro tl. dveří 56 - 65 mm	Kč €	140,- 5,9	093629	370,- 16,-	093728	370,- 16,-	103939	370,- 16,-	104028	370,- 16,-	104141
délka čtyřhranu 125 mm pro tl. dveří 66 - 75 mm	Kč €	160,- 6,7	093636	380,- 16,-	103854	380,- 16,-	103946	380,- 16,-	104059	380,- 16,-	104189
délka čtyřhranu 135 mm pro tl. dveří 76 - 85 mm	Kč €	170,- 7,1	093643	400,- 17,-	103861	400,- 17,-	103977	400,- 17,-	104066	400,- 17,-	104073
spec. délka čtyřhranu pro tl. dveří 86 mm a více	Kč €	200,- 8,4	093650	430,- 18,-	103892	430,- 18,-	103984	430,- 18,-	104523	430,- 18,-	104080

Standardní čtyřhran délky 95 mm v barvě kliky pro tl. dveří 38 - 45 mm je součástí balení. Pro větší tloušťky dveří se čtyřhrany objednávají samostatně podle tabulky, tzn. že pro dveře od tl. 46 mm není čtyřhran součástí balení a je zapotřebí ho objednat zvlášť podle tabulky výše.

		TiN-K		TiN-B		TiN-A		TiN-C		NRz *)		K-industrial	
		cena	EAN	cena	EAN	cena	EAN	cena	EAN	cena	EAN	cena	EAN
Industry Squelette	Kč €	2970,- 124,-	104097	3260,- 136,-	104103	3260,- 136,-	104110	3260,- 136,-	104127	2140,- 90,-	101430	2970,- 124,-	142648

\*) Kliky na sklo v povrchu NRz - nerez broušeno se kombinuje se zámkem na sklo Mini NRz a pantem Entero NRz, viz sekce v katalogu Nerezové zámky a panty na sklo.

		TiN-K		TiN-B		TiN-A		TiN-C		K-industrial	
		cena	EAN	cena	EAN	cena	EAN	cena	EAN	cena	EAN
standard	Kč €	10280,- 429,-	87798	10660,- 445,-	90774	10660,- 445,-	104295	9870,- 412,-	87835	10280,- 429,-	137859
cyklindrický	Kč €	10350,- 432,-	87804	10740,- 448,-	90781	10740,- 448,-	104301	9980,- 416,-	87842	10350,- 432,-	137866
WC	Kč €	11530,- 481,-	87811	11930,- 498,-	90798	11930,- 498,-	104318	11160,- 465,-	87859	11530,- 481,-	137873
protikus	Kč €	11850,- 494,-	87828	12250,- 511,-	90804	12250,- 511,-	104325	11470,- 478,-	87866	11850,- 494,-	137880

Uvedené ceny za zámky bez klik. Kliky/rukojeti se objednávají zvlášť a jsou uvedeny v tabulce výše.

		TiN-K		TiN-B		TiN-C		TiN-A		K-industrial	
		cena	EAN	cena	EAN	cena	EAN	cena	EAN	cena	EAN
	Kč €	7420,- 310,-	88191	7770,- 324,-	88214	7080,- 295,-	88207	7770,- 324,-	104332	7420,- 310,-	137897

Součástí pantů a v ceně sady pantů je střední díl pantu a vložka závěsu.



**Okenní klika  
Industry Squelette**

1850,- Kč  
78,- EUR

TiN-K titan černý mat

materiál: nerezová ocel  
Kč povrch: NRz nerez - broušeno EUR

1850,-		78,-
2000,-		84,-



**Klika Industry Squelette  
pro Al profily**

3640,- Kč  
152,- EUR

TiN-K titan černý mat

materiál: nerezová ocel  
Kč povrch: NRz nerez - broušeno EUR

3640,-		152,-
4350,-		182,-
4350,-		182,-
940,-		40,-



**Madlo dlouhé Industry Squelette**

11020,- Kč  
460,- EUR

TiN-K titan černý mat

Madlo je celé ručně vyráběné, konstrukčně komplikované, ale velmi pevné. Nikdy nebude tvarově dokonalé, každý kus je originál.

materiál: nerezová ocel  
Kč povrch: NRz nerez - broušeno EUR

11020,-		460,-
5520,-		230,-

		NRz		TiN-K		TiN-B		TiN-A		TiN-C		K-industrial	
		cena	EAN	cena	EAN	cena	EAN	cena	EAN	cena	EAN	cena	EAN
		ks		ks		ks		ks		ks		ks	
oválná rozeta	Kč €	1850,- 78,-	104370	2420,- 101,-	104417	2710,- 113,-	104431	2710,- 113,-	104455	2710,- 113,-	104479	2420,- 101,-	104394
obdélníková rozeta	Kč €	2000,- 84,-	104387	2550,- 107,-	104424	2840,- 119,-	104448	2840,- 119,-	104462	2840,- 119,-	104486	2550,- 107,-	104400

Polohovací mechanismus s plochým štítkem je 3-polohový kovový a je součástí příslušenství okenní kliky, lze ho zapustit včetně štítku do rámu okna. Viditelný čtyřhran ovládací mechaniky nelze pokovit do barvy kliky. Ovládací mechanika se čtyřhranem je standardně dodávána ve stříbrném pozinku.

		NRz		TiN-K		TiN-B		TiN-A		TiN-C		K-industrial	
		cena	EAN	cena	EAN	cena	EAN	cena	EAN	cena	EAN	cena	EAN
		pár		pár		pár		pár		pár		pár	
klika / klika	Kč €	3640,- 152,-	104493	4910,- 205,-	104578	5330,- 223,-	104615	5330,- 223,-	104653	5330,- 223,-	104691	4910,- 205,-	104530
madlo / klika L	Kč €	4350,- 182,-	104509	5490,- 229,-	104585	6180,- 258,-	104622	6180,- 258,-	104660	6180,- 258,-	104707	5490,- 229,-	104547
madlo / klika R	Kč €	4350,- 182,-	104516	5490,- 229,-	104592	6180,- 258,-	104639	6180,- 258,-	104677	6180,- 258,-	104714	5490,- 229,-	104554
rozeta cylindrická 33x49 mm	Kč €	940,- 40,-	024098	1260,- 53,-	024111	1530,- 64,-	104646	1530,- 64,-	104684	1530,- 64,-	104721	1260,- 53,-	034059

Dodáváme s rozetou 33x49 mm - tl. = 12 mm.

		NRz		TiN-K		TiN-B		TiN-A		TiN-C		K-industrial	
		cena	EAN	cena	EAN	cena	EAN	cena	EAN	cena	EAN	cena	EAN
rozteč 250 mm oboustranné	Kč €	pár 11020,- 460,-	103830	pár 13830,- 577,-	103915	pár 15240,- 635,-	103953	pár 15240,- 635,-	103991	pár 15240,- 635,-	104035	pár 13830,- 577,-	103878
rozteč 250 mm jednostranné	Kč €	ks 5520,- 230,-	103847	ks 6930,- 289,-	103922	ks 7640,- 319,-	103960	ks 7640,- 319,-	104004	ks 7640,- 319,-	104042	ks 6930,- 289,-	103885

Montážní materiál pro madla	cena	EAN	Montážní materiál pro madla	cena	EAN		
	sada			sada			
jednostranné do slepé díry - plast	Kč €	420,- 18,-	030204	jednostranné s prošroubováním a záslepkou	Kč €	420,- 18,-	003024
jednostranné do slepé díry - hliník	Kč €	420,- 18,-	030211	jednostranné na sklo s prošroubováním a záslepkou	Kč €	550,- 23,-	003031
jednostranné do slepé díry - dřevo	Kč €	420,- 18,-	030228	oboustranné	Kč €	420,- 18,-	003048
				oboustranné na sklo	Kč €	550,- 23,-	003055

Ceny modelů jsou uvedeny bez montážního materiálu. Montážní materiál je nutno specifikovat podle materiálu dveří.









## klika INDUSTRY SQUELETTE

design: Roman Ulich  
materiál: nerezová ocel  
mechanika: magnetická rozeta s vratnou pružinou



## UP & DOWN

1 klika - 2 tvary

výjimečný designérský počín, kdy lze pouhou změnou pozice na dveřích úplně zaměnit osobitý výraz kliky, její vnímání i ovládání



design: Herrmann & Coufal



Dveřní kliky DESIGN 2021 **Up & Down**

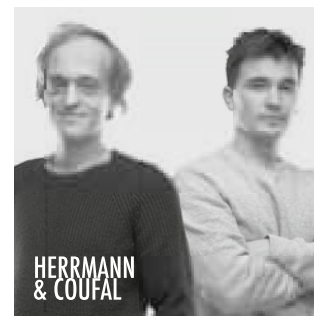

Materiál: masivní mosaz 

Povrchy: Sni-broušeno, Cr, TiN-A, TiN-C, TiN-B, TiN-K  
více info na [www.kliky-mt.cz/manufaktura/barvy-povrchy](http://www.kliky-mt.cz/manufaktura/barvy-povrchy)



Konstrukce, mechanika: magnetické rozety, mechanika M2018



**UP** TiN-K titan černý mat



**DOWN** TiN-A titan mosaz mat



-  Klika/klika + magnetické rozety
-  Koule/klika R + magnetické rozety
-  Koule/klika L + magnetické rozety

-  Klika/klika + magnetické rozety
-  Koule/klika R + magnetické rozety
-  Koule/klika L + magnetické rozety

-  Rozety dozické
-  Rozety cylindrické
-  Rozety WC
-  Rozety zaslepovací



dozické



cylindrické



zaslepovací



WC ex



WC in



koule Maty

magnetické rozety Ø 54 mm, tl. 5 mm

konstrukční varianty, materiálové provedení

- set kování s 1 vratnou pružinou
- standardně bez spodních rozet
- spodní rozety se objednávají samostatně
- sešroubování pouzdry proti sobě
- příprava do dveří: vrtání otvoru průměr 24 – 25mm
- zajišťovací gel proti uvolnění červíků
- vrtání PROFI šablonou M&T vrtákem Ø 6,4 mm
- montáž pro tloušťky dveří 38 – 70 mm
- v balení standardně montážní materiál pro tl. dveří 38 - 42 mm
- záruka 3 roky, titany 15 let

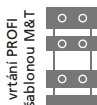

Chráněné průmyslové vzory klik

**design**

**UP**  
**DOWN**

roky **3** garance let **15** garance



SNi-broušeno matný nikl broušeno

4460,- Kč  
186,- EUR

**Up**

materiál: masivní mosaz  
Kč povrch: SNi matný nikl broušeno EUR

4460,-		186,-
5180,-		216,-
5180,-		216,-



TiN-A titan mosaz mat



TiN-K titan černý mat

**Down**

materiál: masivní mosaz  
Kč povrch: SNi matný nikl broušeno EUR

4460,-		186,-
5180,-		216,-
5180,-		216,-



Cr lesklý chrom

4460,- Kč  
186,- EUR



**Spodní rozety**

materiál: magnetická nerez ocel  
Kč povrch: SNi matný nikl broušeno EUR

720,-		30,-
720,-		30,-
1680,-		70,-
850,-		36,-

720,- Kč  
30,- EUR



V prodeji od 01. 03. 2022

		Sni - broušeno		TiN-C		TiN-K		TiN-B		TiN-A	
		cena	EAN	cena	EAN	cena	EAN	cena	EAN	cena	EAN
		pár		pár		pár		pár		pár	
klika / klika	Kč €	4460,- 186,-	147070	5760,- 240,-	147131	5760,- 240,-	147162	5760,- 240,-	147193	5760,- 240,-	147223
koule / klika R	Kč €	5180,- 216,-	147087	6490,- 271,-	147148	6490,- 271,-	147179	6490,- 271,-	147209	6490,- 271,-	147230
koule / klika L	Kč €	5180,- 216,-	147094	6490,- 271,-	147155	6490,- 271,-	147186	6490,- 271,-	147216	6490,- 271,-	147247

Konstrukce klik vyžaduje dodání vždy přesné délky ovládacího montážního materiálu pro konkrétní tloušťku dveří viz. tabulka montážního materiálu v délkách po 4 mm. Montážní materiál pro standardní tloušťku dveří 38-42 mm je součástí dodávky a je v ceně dodávky.



TiN-B titan braun mat

Montážní materiál							
tloušťka dveří	cena	EAN	tloušťka dveří	cena	EAN		
	sada			sada			
42,1 - 44 mm	Kč €	90,- 3,8	145274	52,1 - 54 mm	Kč €	130,- 5,5	145328
44,1 - 46 mm	Kč €	90,- 3,8	145281	54,1 - 56 mm	Kč €	130,- 5,5	145335
46,1 - 48 mm	Kč €	90,- 3,8	145298	56,1 - 58 mm	Kč €	130,- 5,5	145342
48,1 - 50 mm	Kč €	90,- 3,8	145304	58,1 - 60 mm	Kč €	130,- 5,5	145359
50,1 - 52 mm	Kč €	130,- 5,5	145311	60,1 mm a více*	Kč €	150,- 6,3	145366

\* nutno určit přesnou tloušťku dveří

		Sni - broušeno		Cr		TiN-C		TiN-K		TiN-B		TiN-A	
		cena	EAN	cena	EAN	cena	EAN	cena	EAN	cena	EAN	cena	EAN
		pár		pár		pár		pár		pár		pár	
klika / klika	Kč €	4460,- 186,-	147254	4730,- 198,-	147285	5760,- 240,-	147315	5760,- 240,-	147346	5760,- 240,-	147377	5760,- 240,-	147407
koule / klika R	Kč €	5180,- 216,-	147261	5440,- 227,-	147292	6490,- 271,-	147322	6490,- 271,-	147353	6490,- 271,-	147384	6490,- 271,-	147414
koule / klika L	Kč €	5180,- 216,-	147278	5440,- 227,-	147308	6490,- 271,-	147339	6490,- 271,-	147360	6490,- 271,-	147391	6490,- 271,-	147421

Konstrukce klik vyžaduje dodání vždy přesné délky ovládacího montážního materiálu pro konkrétní tloušťku dveří viz. tabulka montážního materiálu v délkách po 4 mm. Montážní materiál pro standardní tloušťku dveří 38-42 mm je součástí dodávky a je v ceně dodávky.

		Magnetická rozeta											
		Sni - broušeno		Cr		TiN-C		TiN-K		TiN-B		TiN-A	
		cena / pár	EAN	cena / pár	EAN	cena / pár	EAN	cena / pár	EAN	cena / pár	EAN	cena / pár	EAN
dozické	Kč €	720,- 30,-	144901	840,- 35,-	095654	1340,- 56,-	095678	1340,- 56,-	091601	1340,- 56,-	095685	1340,- 56,-	095661
cylindrické	Kč €	720,- 30,-	144918	840,- 35,-	095715	1340,- 56,-	095739	1340,- 56,-	091618	1340,- 56,-	095746	1340,- 56,-	095722
WC	Kč €	1680,- 70,-	144840	1900,- 80,-	144857	2220,- 93,-	144864	2220,- 93,-	144871	2220,- 93,-	144888	2220,- 93,-	144895
zaslepovací	Kč €	850,- 36,-	144925	980,- 41,-	101157	1490,- 63,-	104905	1490,- 63,-	104875	1490,- 63,-	104882	1490,- 63,-	104899

## Oblíbené povrchy



vrtání otvorů  
pro magnetické rozety

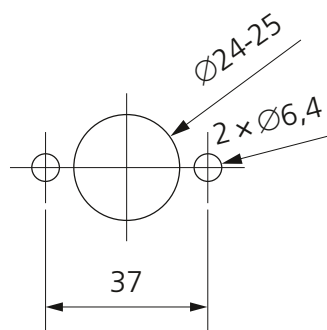

**TiN-K** titan černý mat  
**TiN-A** titan mosaz mat  
**TiN-B** titan braun mat

**UP**



**DOWN**



## NOMAD

mimořádně subtilní  
mimořádně kreativní  
mimořádně pevný

design: Eva Le Peutrec

Dveřní kliky DESIGN 2023 **Nomad, Nomad Touch**

Materiál: masivní mosaz + vysokopevnostní ocel



Povrchy: Sni-broušeno, Cr, Cr-K, TiN-M, TiN-C, TiN-K, TiN-G, TiN-B, TiN-S, TiN-A, Wh  
více info na [www.kliky-mt.cz/manufaktura/barvy-povrchy](http://www.kliky-mt.cz/manufaktura/barvy-povrchy)

Konstrukce, mechanika: magnetické rozety, mechanika M2018





**NOMAD** TiN-K titan černý mat





-  Klika/klika + magnetické rozety
-  Koule/klika R + magnetické rozety
-  Koule/klika L + magnetické rozety

**NOMAD TOUCH** TiN-A titan mosaz mat



-  Klika/klika + magnetické rozety
-  Koule/klika R + magnetické rozety
-  Koule/klika L + magnetické rozety

-  Rozety dozické
-  Rozety cylindrické
-  Rozety WC
-  Rozety zaslepovací



dozické

cylindrické

zaslepovací

WC ex

WC in

koule Maty

magnetické rozety Ø 54 mm, tl. 5 mm

konstrukční varianty, materiálové provedení

- designová sada standardně bez spodních rozet
- spodní rozety se objednávají samostatně
- konstrukční systém s vratnou pružinou u kliky
- montáž sešroubování pouzdry proti sobě
- rukojeti vyrobeny z masivní mosazi
- rozety vyrobeny z magnetické nerez oceli
- zajišťovací gel proti uvolnění šroubů
- vrtání PROFI šablonou M&T vrtákem Ø 6,4 mm
- montáž pro tloušťky dveří 38 – 126 mm
- v balení standardně montážní materiál pro tl. dveří 38 - 45 mm
- záruka 3 roky, titany 15 let

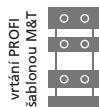

Chráněné průmyslové vzory klik

design

**NOMAD**  
**NOMAD TOUCH**

roky **3 garance** let **15 garance**



**SNi** matný nikel

**Nomad**

2700,- Kč  
113,- EUR

Kč	materiál: masivní mosaz povrch: SNi matný nikel	EUR
2700,-		113,-
3720,-		155,-
3720,-		155,-



**TiN-M** titan měď broušeno



**TiN-A** titan mosaz mat



**TiN-K** titan černý mat



**Spodní rozety**

720,- Kč  
30,- EUR

Kč	materiál: magnetická nerez ocel povrch: SNi matný nikel	EUR
720,-		30,-
720,-		30,-
1190,-		50,-
850,-		36,-







		SNI		Cr		Cr-K		TiN-M		TiN-C		TiN-K		TiN-G	
		cena / pár	EAN	cena / pár	EAN	cena / pár	EAN	cena / pár	EAN	cena / pár	EAN	cena / pár	EAN	cena / pár	EAN
klika / klika	Kč €	2700,- 113,-	166132	3000,- 125,-	166163	4300,- 180,-	166408	4300,- 180,-	166286	3900,- 163,-	166194	3900,- 163,-	166439	3900,- 163,-	166378
koule / klika R	Kč €	3720,- 155,-	166149	4040,- 169,-	166170	5620,- 235,-	166415	5620,- 235,-	166293	5120,- 214,-	166200	5120,- 214,-	166446	5120,- 214,-	166385
koule / klika L	Kč €	3720,- 155,-	166156	4040,- 169,-	166187	5620,- 235,-	166422	5620,- 235,-	166309	5120,- 214,-	166217	5120,- 214,-	166453	5120,- 214,-	166392

		TiN-B		TiN-S		TiN-A		Wh	
		cena / pár	EAN	cena / pár	EAN	cena / pár	EAN	cena / pár	EAN
klika / klika	Kč €	3900,- 163,-	166316	3900,- 163,-	166255	3900,- 163,-	166224	3900,- 163,-	166347
koule / klika R	Kč €	5120,- 214,-	166323	5120,- 214,-	166262	5120,- 214,-	166231	5120,- 214,-	166354
koule / klika L	Kč €	5120,- 214,-	166330	5120,- 214,-	166279	5120,- 214,-	166248	5120,- 214,-	166361

Nomad je kreativní - lze nakombinovat jednotlivé části kliky v různých povrchových úpravách. Cena celého setu se určuje podle povrchu rukojeti.



Cr-K černý chrom broušený 3D

		Magnetická rozeta											
		SNI		Cr		Cr-K		TiN-M		TiN-C		TiN-K	
		cena / pár	EAN	cena / pár	EAN	cena / pár	EAN	cena / pár	EAN	cena / pár	EAN	cena / pár	EAN
dozické	Kč €	720,- 30,-	095647	840,- 35,-	095654	1340,- 56,-	101263	1340,- 56,-	166705	1340,- 56,-	095678	1340,- 56,-	091601
cylindrické	Kč €	720,- 30,-	095708	840,- 35,-	095715	1340,- 56,-	101270	1340,- 56,-	166712	1340,- 56,-	095739	1340,- 56,-	091618
WC	Kč €	1190,- 50,-	166613	1340,- 56,-	166620	1950,- 82,-	166637	1950,- 82,-	166729	1850,- 78,-	166644	1650,- 69,-	166651
zaslepovací	Kč €	850,- 36,-	101140	980,- 41,-	101157	1490,- 63,-	101164	1490,- 63,-	166736	1490,- 63,-	104905	1490,- 63,-	104875

		Magnetická rozeta									
		TiN-G		TiN-B		TiN-S		TiN-A		Wh	
		cena / pár	EAN	cena / pár	EAN	cena / pár	EAN	cena / pár	EAN	cena / pár	EAN
dozické	Kč €	1340,- 56,-	165494	1340,- 56,-	095685	1340,- 56,-	165456	1340,- 56,-	095661	1340,- 56,-	166743
cylindrické	Kč €	1340,- 56,-	165500	1340,- 56,-	095746	1340,- 56,-	165463	1340,- 56,-	095722	1340,- 56,-	166750
WC	Kč €	1850,- 78,-	166668	1850,- 78,-	166675	1850,- 78,-	166682	1850,- 78,-	166699	1650,- 69,-	166767
zaslepovací	Kč €	1490,- 63,-	165524	1490,- 63,-	104882	1490,- 63,-	165487	1490,- 63,-	104899	1490,- 63,-	166774

WC mechanismus IN je vždy s vroubkováním. U ručně broušených povrchů Cr-K a TiN-M zůstává WC mechanismus IN bez vroubkování.



**Nomad Touch**

2900,- Kč  
121,- EUR

Kč	materiál: masivní mosaz povrch: SNi matný nikl	EUR
2900,-		121,-
3920,-		164,-
3920,-		164,-



**Okenní klika Nomad**

1620,- Kč  
68,- EUR

Kč	materiál: masivní mosaz povrch: SNi matný nikl	EUR
1620,-		68,-



**Okenní klika Nomad Touch**

1820,- Kč  
76,- EUR

Kč	materiál: masivní mosaz povrch: SNi matný nikl	EUR
1820,-		76,-

	SNI		TiN-C		TiN-K		TiN-G		TiN-B		TiN-S		TiN-A		
	cena	EAN	cena	EAN	cena	EAN	cena	EAN	cena	EAN	cena	EAN	cena	EAN	
	Kč		pár		pár			pár		pár			pár		
klika / klika	€	2900,- 121,-	166460	4100,- 171,-	168044	4100,- 171,-	166583	4100,- 171,-	168075	4100,- 171,-	166552	4100,- 171,-	166521	4100,- 171,-	166491
koule / klika R	€	3920,- 164,-	166477	5320,- 222,-	168051	5320,- 222,-	166590	5320,- 222,-	168082	5320,- 222,-	166569	5320,- 222,-	166538	5320,- 222,-	166507
koule / klika L	€	3920,- 164,-	166484	5320,- 222,-	168068	5320,- 222,-	166606	5320,- 222,-	168099	5320,- 222,-	166576	5320,- 222,-	166545	5320,- 222,-	166514

Varianta Nomad Touch je s vroubkovanou rukojetí.

	SNI		Cr		Cr-K		TiN-M		TiN-C		TiN-K		TiN-G		
	cena	EAN	cena	EAN	cena	EAN	cena	EAN	cena	EAN	cena	EAN	cena	EAN	
	Kč		ks		ks			ks		ks			ks		
plochá oválná rozeta	€	1620,- 68,-	167283	1800,- 75,-	167290	2540,- 106,-	167375	2540,- 106,-	167337	2340,- 98,-	167306	2340,- 98,-	167382	2340,- 98,-	167368

	TiN-B		TiN-S		TiN-A		Wh		
	cena	EAN	cena	EAN	cena	EAN	cena	EAN	
	Kč		ks		ks		ks		
plochá oválná rozeta	€	2340,- 98,-	167344	2340,- 98,-	167320	2340,- 98,-	167313	2340,- 98,-	167351

	SNI		TiN-C		TiN-K		TiN-G		TiN-B		TiN-S		TiN-A		
	cena	EAN	cena	EAN	cena	EAN	cena	EAN	cena	EAN	cena	EAN	cena	EAN	
	Kč		ks		ks			ks		ks			ks		
plochá oválná rozeta	€	1820,- 76,-	167399	2540,- 106,-	168105	2540,- 106,-	167436	2540,- 106,-	168112	2540,- 106,-	167429	2540,- 106,-	167412	2540,- 106,-	167405



**Kliky-rukojeti  
k zámkům na sklo**

materiál: masivní mosaz  
Kč povrch: SNi matný nikl broušeno EUR



1300,-	Nomad	55,-
1450,-	Nomad Touch	61,-



**Zámek na sklo Mini**

5860,- Kč  
245,- EUR

materiál: masivní mosaz  
Kč povrch: SNi matný nikl EUR

5860,-		245,-
6980,-		291,-
7100,-		296,-



SNi matný nikl

**Pant Entero**

5290,- Kč  
221,- EUR

materiál: masivní mosaz  
Kč povrch: SNi matný nikl EUR

5290,-		221,-
--------	---	-------

		SNI - broušeno		Cr		TiN-C		TiN-K		TiN-B		TiN-A	
		cena / pár	EAN	cena / pár	EAN	cena / pár	EAN	cena / pár	EAN	cena / pár	EAN	cena / pár	EAN
Nomad	Kč €	1300,- 55,-	167948	1500,- 63,-	167955	1950,- 82,-	167962	1950,- 82,-	167979	1950,- 82,-	167986	1950,- 82,-	168327
Nomad Touch	Kč €	1450,- 61,-	167993			2050,- 86,-	168013	2050,- 86,-	168020	2050,- 86,-	168037	2050,- 86,-	168006



		SNI		SNI - broušeno		Cr		Ms		TiN-C		TiN-K		TiN-B	
		cena	EAN	cena	EAN	cena	EAN	cena	EAN	cena	EAN	cena	EAN	cena	EAN
standard	Kč €	5860,- 245,-	87934	5860,- 245,-	90811	6400,- 267,-	87873	6400,- 267,-	061277	7640,- 319,-	87996	7990,- 333,-	87965	8340,- 348,-	88023
WC	Kč €	6980,- 291,-	87941	6980,- 291,-	90828	7510,- 313,-	87880	7510,- 313,-	061284	8760,- 365,-	88009	9100,- 380,-	87972	9480,- 395,-	88030
protikus	Kč €	7100,- 296,-	87958	7100,- 296,-	90835	7640,- 319,-	87897	7640,- 319,-	061291	9060,- 378,-	88016	9400,- 392,-	87989	9770,- 408,-	88047

Uvedené ceny za zámký bez klik. Kliky/rukojeti se objednávají zvlášť a jsou uvedeny v tabulce výše.



		SNI		SNI - broušeno		Cr		Ms		TiN-C		TiN-K		TiN-B	
		cena / pár	EAN	cena / pár	EAN	cena / pár	EAN	cena / pár	EAN	cena / pár	EAN	cena / pár	EAN	cena / pár	EAN
	Kč €	5290,- 221,-	88184	5290,- 221,-	90439	6390,- 267,-	88160	6390,- 267,-	061888	7770,- 324,-	88207	7770,- 324,-	88191	7770,- 324,-	88214

Součástí pantů a v ceně sady pantů je střední díl pantu a vložka závěsu.

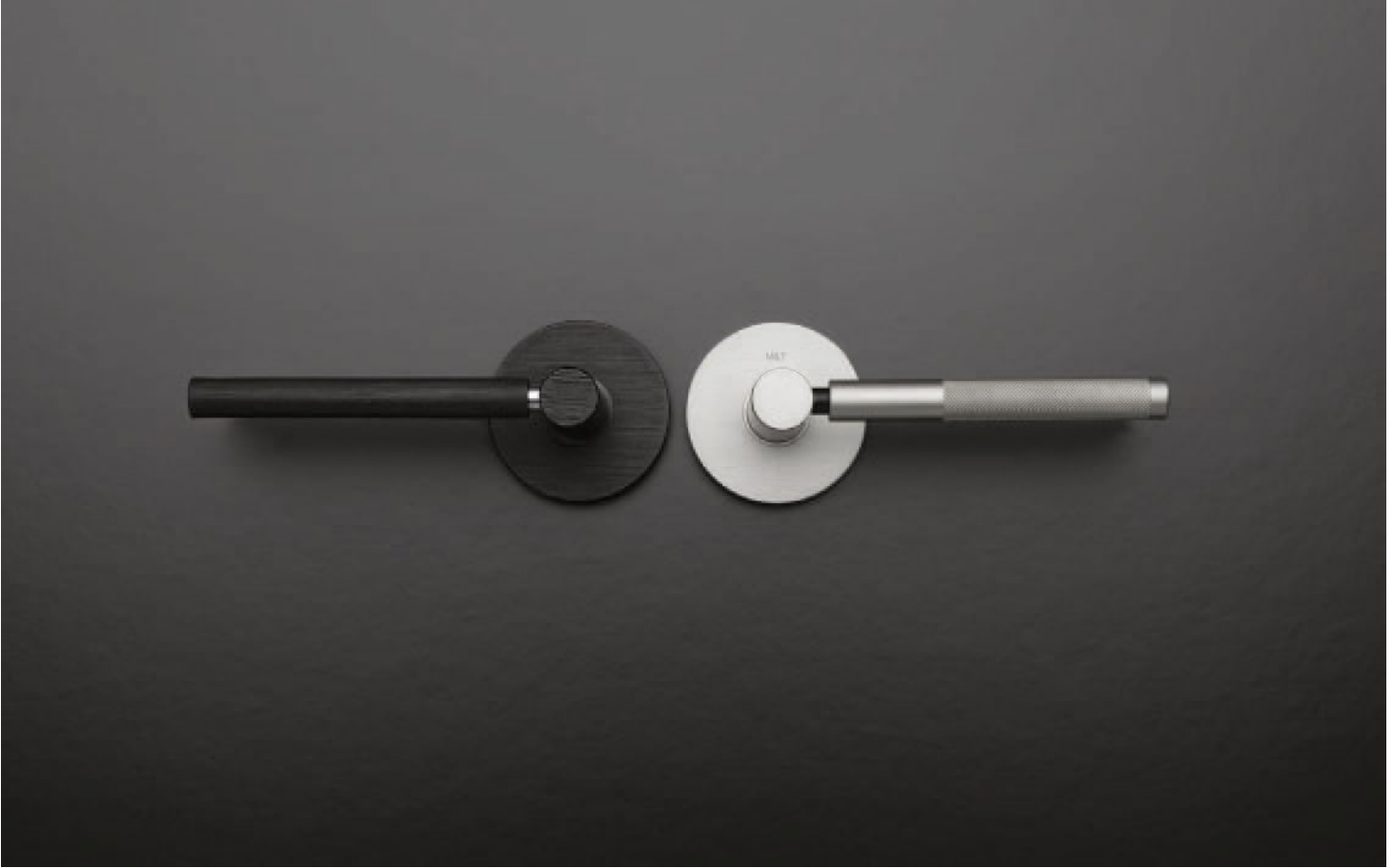

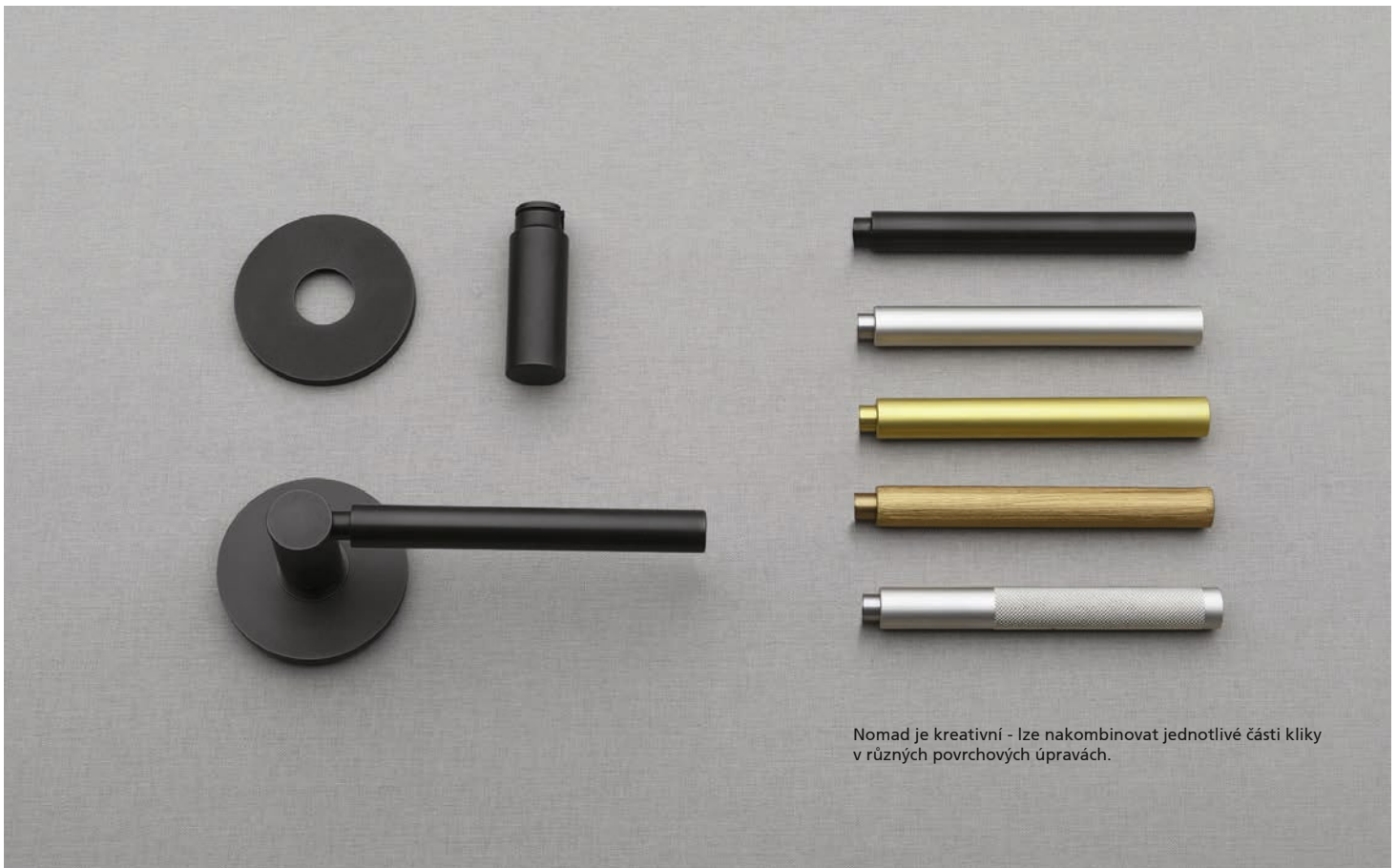
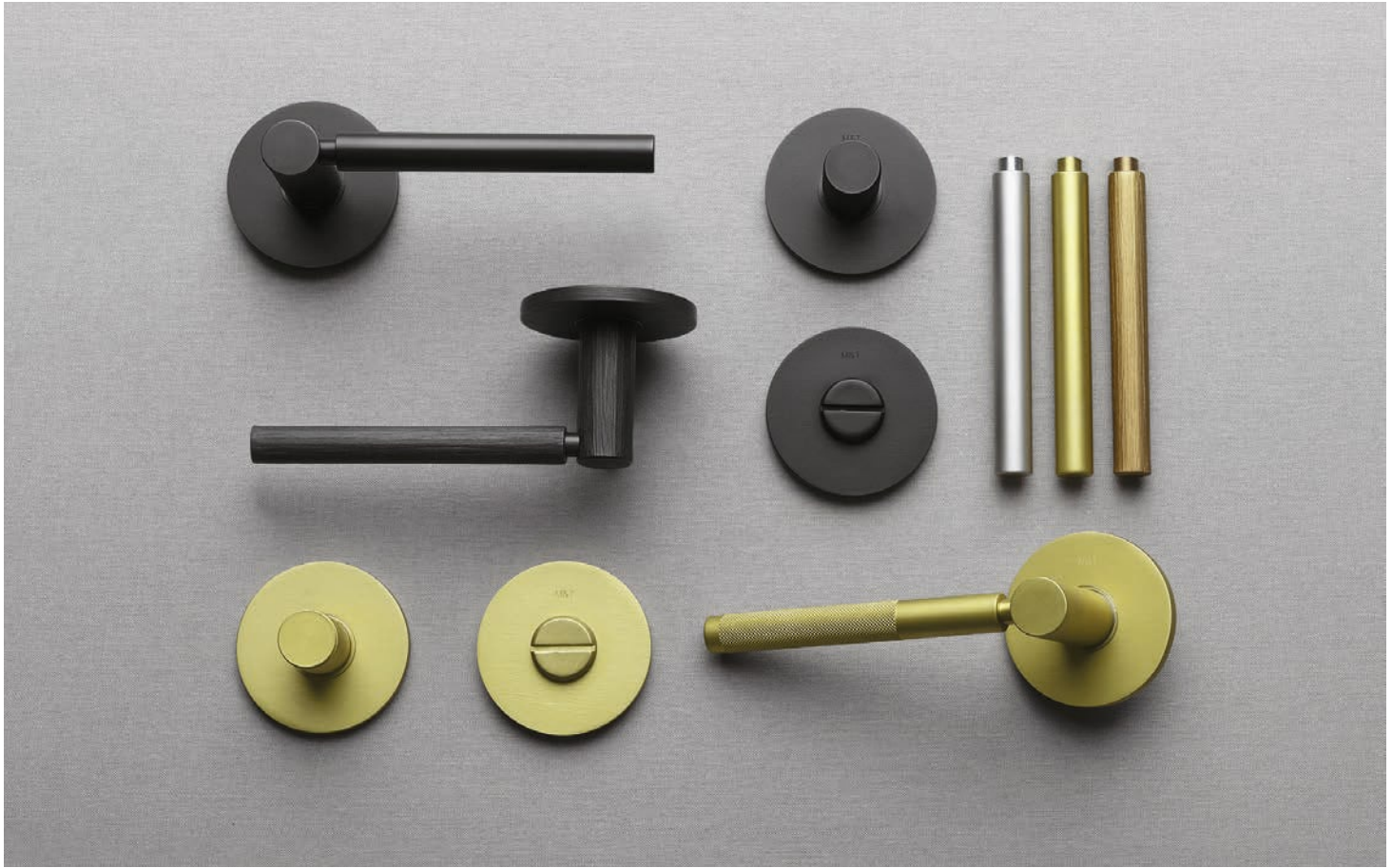

Nomad je kreativní - lze nakombinovat jednotlivé části kliky v různých povrchových úpravách.



Ochranná známka – registrovaná značka **ENTERO®**

Chráněné průmyslové vzory klik **MORGAN  
ENTERO**

Příbuzný sortiment

Kování pro hliníkové a ocelové dveře,  
kování na branky



Rozetové kování



Bezpečnostní štítové kování



Madla dlouhá



Bezpečnostní rozety





## Štitové kování NEREZ

Materiál: **nerezová ocel ANSI 304**

Povrchy: **NRz** nerez - broušeno, **TiN-K** titan černý mat, **K-industrial** černý mat strukturovaný

Nerezové štitové kování M&T je připraveno pro projekty a realizace s požadavkem na standardní design, ale s důrazem na dlouhodobou životnost a perfektní funkčnost. Velkou předností štitového kování M&T je možnost dodávek ve všech požadovaných rozměrech/roztečích i ve variantě plného štitu. Nadstandardem je možnost dodání kování v povrchu TiN-K titan černý mat.

**LUSY NRz** nerez ocel broušeno

**MORGAN TiN-K** titan černý mat

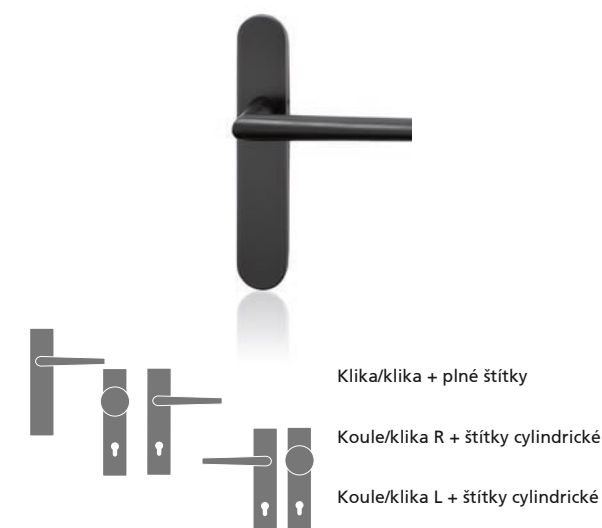
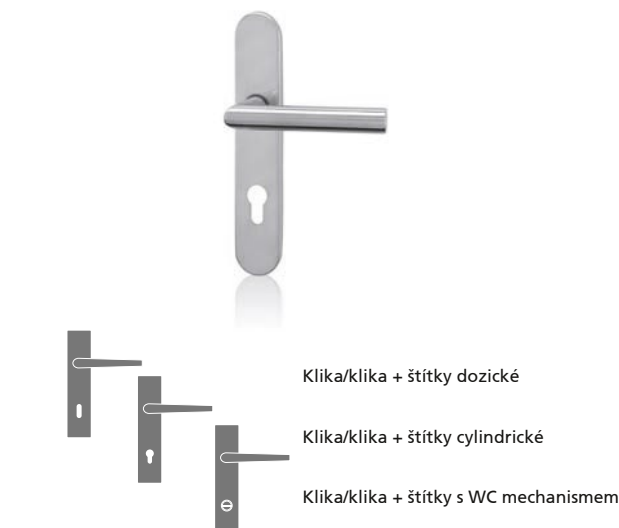

dozické



cylindrické



WC in



WC ex



plný štítek



s koulí Maty

konstrukční varianty, materiálové provedení

### Objekt

- kování s vratnou pružinou
- kovový vnitřní štít
- nacvakávací krycí nerezový štít
- zajišťovací gel
- montáž na dveře do tl. 126 mm
- záruka 5 let, titan 15 let

let **5 garance** let **15 garance**

Zatřídění kování podle normy EN 1906:2012, ČSN EN 1906 16 5776

Prohlášení o shodě na [www.kliky-mt.cz/certifikaty](http://www.kliky-mt.cz/certifikaty)

**Objekt** **36-0031B**

**3** Kategorie použití .. vysoká frekvence používání veřejností nebo jinými uživateli s malou motivací o pečlivé používání a kde je vysoká pravděpodobnost nesprávného použití, např. dveře u veřejných kanceláří

**6** Životnost .. střední frekvence používání: 100 000 cyklů

**-** Hmotnost dveří .. (bez klasifikace)

**0** Požární odolnost .. (není požadována odolnost)

**0** Ochrana .. normální použití

**3** Odolnost proti korozi .. vysoká odolnost

**1** Bezpečnost .. mírná odolnost proti vloupání

**B** Typ ovládání .. kování s vratnou pružinou

### Projekt tř. 4, protipožární odolnost

- kování s vratnou pružinou
- kovový vnitřní štít
- nacvakávací krycí nerezový štít
- celonerezové provedení vč. krčku
- nerezový čtyřhran
- nerezový červík
- zajišťovací gel
- montáž na dveře do tl. 126 mm
- záruka 7 let, titan 15 let

let **7 garance** let **15 garance**

**Projekt tř. 4** **47-D1141B**

**4** Kategorie použití .. vysoká frekvence používání na dveřích, které jsou předmětem častého hrubého používání, např. fotbalové stadiony, kasárna, veřejné toalety, atd.

**7** Životnost .. vysoká frekvence používání: 200 000 cyklů

**-** Hmotnost dveří .. (bez klasifikace)

**D1** Požární odolnost .. pro použití na kouřotěsných a požárně odolných dveřích s požadavky na speciální střed v klíče/knoflíku, zkoušených s 200000 cykly na zkušebních dveřích.

**1** Ochrana .. použití v situacích vyžadujících ochranu

**4** Odolnost proti korozi .. velmi vysoká odolnost

**1** Bezpečnost .. mírná odolnost proti vloupání

**B** Typ ovládání .. kování s vratnou pružinou



NRz nerez - broušeno

**Lusy**

1400,- Kč  
59,- EUR



**Deny**

1400,- Kč  
59,- EUR



**Entero**

2800,- Kč  
117,- EUR

materiál: nerezová ocel  
povrch: NRz nerez - broušeno

**Kč** **EUR**

1400,-		59,-
1400,-		59,-
1860,-		78,-
2180,-		91,-
2180,-		91,-

1400,-		59,-
1400,-		59,-
1860,-		78,-
2180,-		91,-
2180,-		91,-
1720,-		72,-

1400,-		59,-
1400,-		59,-
1860,-		78,-
2180,-		91,-
2180,-		91,-

1400,-		59,-
1400,-		59,-
1860,-		78,-
2180,-		91,-
2180,-		91,-
1720,-		72,-

2800,-		117,-
2800,-		117,-
3370,-		141,-
3730,-		156,-
3730,-		156,-

2800,-		117,-
2800,-		117,-
3370,-		141,-
3730,-		156,-
3730,-		156,-
3110,-		130,-

Orientace WC:  
WC in je namontované automaticky u pravé kliky R. Požadovanou jinou orientaci WC je nutno upřesnit.

	Objekt nerez			Objekt titan		Objekt		Projekt tř. 4, (i protipožární)		Projekt tř. 4, (i protipožární)	
	NRz			TiN-K		K-industrial		NRz		TiN-K	
	cena / pár	EAN		cena / pár	EAN	cena / pár	EAN	cena / pár	EAN	cena / pár	EAN
<b>72 mm</b>											
dozický	Kč €	1400,- 59,-	017892	2950,- 123,-	017946	2950,- 123,-	032444	1720,- 72,-	017991	3260,- 136,-	018042
cylinrický	Kč €	1400,- 59,-	017908	2950,- 123,-	017953	2950,- 123,-	032451	1720,- 72,-	018004	3260,- 136,-	018059
WC	Kč €	1860,- 78,-	017915	3420,- 143,-	017960	3420,- 143,-	032468	2180,- 91,-	018011	3730,- 156,-	018066
koule / klika R	Kč €	2180,- 91,-	017922	3730,- 156,-	017977	4040,- 169,-	032475	2500,- 105,-	018028	4040,- 169,-	018073
koule / klika L	Kč €	2180,- 91,-	017939	3730,- 156,-	017984	3730,- 156,-	032482	2500,- 105,-	018035	4040,- 169,-	018080
<b>90 mm</b>											
dozický	Kč €	1400,- 59,-	018899	2950,- 123,-	018943	2950,- 123,-	032499	1720,- 72,-	018998	3260,- 136,-	019049
cylinrický	Kč €	1400,- 59,-	018905	2950,- 123,-	018950	2950,- 123,-	032505	1720,- 72,-	019001	3260,- 136,-	019056
WC	Kč €	1860,- 78,-	018912	3420,- 143,-	018967	3420,- 143,-	032512	2180,- 91,-	019018	3730,- 156,-	019063
koule / klika R	Kč €	2180,- 91,-	018929	3730,- 156,-	018974	3730,- 156,-	032529	2500,- 105,-	019025	4040,- 169,-	019070
koule / klika L	Kč €	2180,- 91,-	018936	3730,- 156,-	018981	3730,- 156,-	032536	2500,- 105,-	019032	4040,- 169,-	019087
plný štítek	Kč €	1720,- 72,-	023152	3260,- 136,-	023169	3260,- 136,-	032543	2030,- 85,-	023176	3590,- 150,-	023183
<b>72 mm</b>											
dozický	Kč €	1400,- 59,-	018097	2950,- 123,-	018141	2950,- 123,-	032550	1720,- 72,-	018196	3260,- 136,-	018240
cylinrický	Kč €	1400,- 59,-	018103	2950,- 123,-	018158	2950,- 123,-	032567	1720,- 72,-	018202	3260,- 136,-	018257
WC	Kč €	1860,- 78,-	018110	3420,- 143,-	018165	3420,- 143,-	032574	2180,- 91,-	018219	3730,- 156,-	018264
koule / klika R	Kč €	2180,- 91,-	018127	3730,- 156,-	018172	3730,- 156,-	032581	2500,- 105,-	018226	4040,- 169,-	018271
koule / klika L	Kč €	2180,- 91,-	018134	3730,- 156,-	018189	3730,- 156,-	032598	2500,- 105,-	018233	4040,- 169,-	018288
<b>90 mm</b>											
dozický	Kč €	1400,- 59,-	019094	2950,- 123,-	019148	2950,- 123,-	032604	1720,- 72,-	019193	3260,- 136,-	019247
cylinrický	Kč €	1400,- 59,-	019100	2950,- 123,-	019155	2950,- 123,-	032611	1720,- 72,-	019209	3260,- 136,-	019254
WC	Kč €	1860,- 78,-	019117	3420,- 143,-	019162	3420,- 143,-	032628	2180,- 91,-	019216	3730,- 156,-	019261
koule / klika R	Kč €	2180,- 91,-	019124	3730,- 156,-	019179	3730,- 156,-	032635	2500,- 105,-	019223	4040,- 169,-	019278
koule / klika L	Kč €	2180,- 91,-	019131	3730,- 156,-	019186	3730,- 156,-	032642	2500,- 105,-	019230	4040,- 169,-	019285
plný štítek	Kč €	1720,- 72,-	023190	3260,- 136,-	023206	3260,- 136,-	032659	2030,- 85,-	023213	3590,- 150,-	023220
<b>72 mm</b>											
dozický	Kč €	2800,- 117,-	018691	4350,- 182,-	018745	4350,- 182,-	032666	3110,- 130,-	018790	4650,- 194,-	018844
cylinrický	Kč €	2800,- 117,-	018707	4350,- 182,-	018752	4350,- 182,-	032673	3110,- 130,-	018806	4650,- 194,-	018851
WC	Kč €	3370,- 141,-	018714	4910,- 205,-	018769	4910,- 205,-	032680	3660,- 153,-	018813	5230,- 218,-	018868
koule / klika R	Kč €	3730,- 156,-	018721	5280,- 220,-	018776	5280,- 220,-	032697	4040,- 169,-	018820	5590,- 233,-	018875
koule / klika L	Kč €	3730,- 156,-	018738	5280,- 220,-	018783	5280,- 220,-	032703	4040,- 169,-	018837	5590,- 233,-	018882
<b>90 mm</b>											
dozický	Kč €	2800,- 117,-	019698	4350,- 182,-	019742	4350,- 182,-	032710	3110,- 130,-	019797	4650,- 194,-	019841
cylinrický	Kč €	2800,- 117,-	019704	4350,- 182,-	019759	4350,- 182,-	032727	3110,- 130,-	019803	4650,- 194,-	019858
WC	Kč €	3370,- 141,-	019711	4910,- 205,-	019766	4910,- 205,-	032734	3660,- 153,-	019810	5230,- 218,-	019865
koule / klika R	Kč €	3730,- 156,-	019728	5280,- 220,-	019773	5280,- 220,-	032741	4040,- 169,-	019827	5590,- 233,-	019872
koule / klika L	Kč €	3730,- 156,-	019735	5280,- 220,-	019780	5280,- 220,-	032758	4040,- 169,-	019834	5590,- 233,-	019889
plný štítek	Kč €	3110,- 130,-	023237	4650,- 194,-	023244	4650,- 194,-	032765	3420,- 143,-	023251	4980,- 208,-	023268

Individuálně podle charakteru a rozsahu zakázky možno dodat kování i v jiné rozteči. Cena se kalkuluje jako za plný štít.

Standardně dodáváno s pevnou koulí Maty. Zakázkově možnosť sešroubování pomocí sešroubovacích pouzder skrze dveřní křídlo viz. Příslušenství a komponenty str. 369.



NRz nerez - broušeno

**Meclis**

1550,- Kč  
65,- EUR



TiN-K titan černý mat  
plný štítek

**Morgan**

1550,- Kč  
65,- EUR



**Cesan**

1720,- Kč  
72,- EUR

materiál: nerezová ocel  
povrch: NRz nerez - broušeno

**Kč** **EUR**

1550,-		65,-
1550,-		65,-
2030,-		85,-
2330,-		98,-
2330,-		98,-

1550,-		65,-
1550,-		65,-
2030,-		85,-
2330,-		98,-
2330,-		98,-
1860,-		78,-

1550,-		65,-
1550,-		65,-
2030,-		85,-
2330,-		98,-
2330,-		98,-

1550,-		65,-
1550,-		65,-
2030,-		85,-
2330,-		98,-
2330,-		98,-
1860,-		78,-

1720,-		72,-
1720,-		72,-
2180,-		91,-
2500,-		105,-
2500,-		105,-

1720,-		72,-
1720,-		72,-
2180,-		91,-
2500,-		105,-
2500,-		105,-
2030,-		85,-

Orientace WC:  
WC in je namontované automaticky u pravé kliky R. Požadovanou jinou orientaci WC je nutno upřesnit.

	Objekt nerez			Objekt titan		Objekt		Projekt tř. 4, (i protipožární)		Projekt tř. 4, (i protipožární)	
	NRz			TiN-K		K-industrial		NRz		TiN-K	
	cena / pár	EAN		cena / pár	EAN	cena / pár	EAN	cena / pár	EAN	cena / pár	EAN
<b>72 mm</b>											
dozický	Kč €	1550,- 65,-	018295	3110,- 130,-	018349	3110,- 130,-	032772	1860,- 78,-	018394	3420,- 143,-	018448
cyldrický	Kč €	1550,- 65,-	018301	3110,- 130,-	018356	3110,- 130,-	032789	1860,- 78,-	018400	3420,- 143,-	018455
WC	Kč €	2030,- 85,-	018318	3590,- 150,-	018363	3590,- 150,-	032796	2330,- 98,-	018417	3880,- 162,-	018462
koule / klika R	Kč €	2330,- 98,-	018325	3880,- 162,-	018370	3880,- 162,-	032802	2640,- 110,-	018424	4190,- 175,-	018479
koule / klika L	Kč €	2330,- 98,-	018332	3880,- 162,-	018387	3880,- 162,-	032819	2640,- 110,-	018431	4190,- 175,-	018486
<b>90 mm</b>											
dozický	Kč €	1550,- 65,-	019292	3110,- 130,-	019346	3110,- 130,-	032826	1860,- 78,-	019391	3420,- 143,-	019445
cyldrický	Kč €	1550,- 65,-	019308	3110,- 130,-	019353	3110,- 130,-	032833	1860,- 78,-	019407	3420,- 143,-	019452
WC	Kč €	2030,- 85,-	019315	3590,- 150,-	019360	3590,- 150,-	032840	2330,- 98,-	019414	3880,- 162,-	019469
koule / klika R	Kč €	2330,- 98,-	019322	3880,- 162,-	019377	3880,- 162,-	032857	2640,- 110,-	019421	4190,- 175,-	019476
koule / klika L	Kč €	2330,- 98,-	019339	3880,- 162,-	019384	3880,- 162,-	032864	2640,- 110,-	019438	4190,- 175,-	019483
plný štítek	Kč €	1860,- 78,-	023275	3420,- 143,-	023282	3420,- 143,-	032871	2180,- 91,-	023299	3730,- 156,-	023305
<b>72 mm</b>											
dozický	Kč €	1550,- 65,-	018493	3110,- 130,-	018547	3110,- 130,-	032888	1860,- 78,-	018592	3420,- 143,-	018646
cyldrický	Kč €	1550,- 65,-	018509	3110,- 130,-	018554	3110,- 130,-	032895	1860,- 78,-	018608	3420,- 143,-	018653
WC	Kč €	2030,- 85,-	018516	3590,- 150,-	018561	3590,- 150,-	032901	2330,- 98,-	018615	3880,- 162,-	018660
koule / klika R	Kč €	2330,- 98,-	018523	3880,- 162,-	018578	3880,- 162,-	032918	2640,- 110,-	018622	4190,- 175,-	018677
koule / klika L	Kč €	2330,- 98,-	018530	3880,- 162,-	018585	3880,- 162,-	032925	2640,- 110,-	018639	4190,- 175,-	018684
<b>90 mm</b>											
dozický	Kč €	1550,- 65,-	019490	3110,- 130,-	019544	3110,- 130,-	032932	1860,- 78,-	019599	3420,- 143,-	019643
cyldrický	Kč €	1550,- 65,-	019506	3110,- 130,-	019551	3110,- 130,-	032949	1860,- 78,-	019605	3420,- 143,-	019650
WC	Kč €	2030,- 85,-	019513	3590,- 150,-	019568	3590,- 150,-	032956	2330,- 98,-	019612	3880,- 162,-	019667
koule / klika R	Kč €	2330,- 98,-	019520	3880,- 162,-	019575	3880,- 162,-	032963	2640,- 110,-	019629	4190,- 175,-	019674
koule / klika L	Kč €	2330,- 98,-	019537	3880,- 162,-	019582	3880,- 162,-	032970	2640,- 110,-	019636	4190,- 175,-	019681
plný štítek	Kč €	1860,- 78,-	023312	3420,- 143,-	023329	3420,- 143,-	032987	2180,- 91,-	023336	3730,- 156,-	023343
<b>72 mm</b>											
dozický	Kč €	1720,- 72,-	022759	3260,- 136,-	022803	3260,- 136,-	032994	2030,- 85,-	022858	3590,- 150,-	022902
cyldrický	Kč €	1720,- 72,-	022766	3260,- 136,-	022810	3260,- 136,-	033007	2030,- 85,-	022865	3590,- 150,-	022919
WC	Kč €	2180,- 91,-	022773	3730,- 156,-	022827	3730,- 156,-	033014	2500,- 105,-	022872	4040,- 169,-	022926
koule / klika R	Kč €	2500,- 105,-	022780	4040,- 169,-	022834	4040,- 169,-	033021	2800,- 117,-	022889	4350,- 182,-	022933
koule / klika L	Kč €	2500,- 105,-	022797	4040,- 169,-	022841	4040,- 169,-	033038	2800,- 117,-	022896	4350,- 182,-	022940
<b>90 mm</b>											
dozický	Kč €	1720,- 72,-	022957	3260,- 136,-	023008	3260,- 136,-	033045	2030,- 85,-	023053	3590,- 150,-	023107
cyldrický	Kč €	1720,- 72,-	022964	3260,- 136,-	023015	3260,- 136,-	033052	2030,- 85,-	023060	3590,- 150,-	023114
WC	Kč €	2180,- 91,-	022971	3730,- 156,-	023022	3730,- 156,-	033069	2500,- 105,-	023077	4040,- 169,-	023121
koule / klika R	Kč €	2500,- 105,-	022988	4040,- 169,-	023039	4040,- 169,-	033076	2800,- 117,-	023084	4350,- 182,-	023138
koule / klika L	Kč €	2500,- 105,-	022995	4040,- 169,-	023046	4040,- 169,-	033083	2800,- 117,-	023091	4350,- 182,-	023145
plný štítek	Kč €	2030,- 85,-	023350	3590,- 150,-	023367	3590,- 150,-	033090	2330,- 98,-	023374	3880,- 162,-	023381

Individuálně podle charakteru a rozsahu zakázky možno dodat kování i v jiné rozteči. Cena se kalkuluje jako za plný štít.

Standardně dodáváno s pevnou koulí Maty. Zakázkově možnosť sešroubování pomocí sešroubovacích pouzder skrze dveřní křídlo viz. Příslušenství a komponenty str. 369.



Celý projekt - jeden design

Štitové kování DESIGN 2000, 2004



Dveřní kliky DESIGN 2000, 2004



Kování pro hliníkové a ocelové dveře,  
kování na branky



Kliky a zámky  
na skleněné dveře



Madla a koule na skleněné  
a dřevěné dveře



Panty na skleněné dveře



Bezpečnostní rozety



Hranaté panty na dřevěné  
dveře



Mušle na posuvné  
dveře



Okenní kliky  
3 a 4 polohové



## Štitové kování DESIGN 2000, 2004

Materiál: masivní mosaz 

Povrchy: SNI, Cr, TiN-C, TiN-K, Ms, Ms-L, zakázkově TiN-S, TiN-A  
více info na [www.kliky-mt.cz/manufaktura/barvy-povrchy](http://www.kliky-mt.cz/manufaktura/barvy-povrchy)

Štitové kování M&T je vyráběno v několika designech štítků se širokým využitím. Předností štitového kování M&T je možnost dodávek v požadovaných rozměrech/roztečích 72 a 90 mm i ve variantě plného štítu. Nadstandardně jsou připraveny kombinace s titanovým povrchem v několika barevných odstínech.

**BURAK SNI** matný nikl

**GARANTI SNI** matný nikl

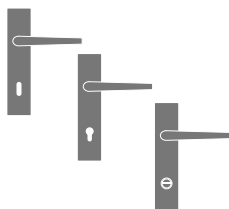

Klika/klika + štítky dozické

Klika/klika + štítky cylindrické

Klika/klika + štítky s WC mechanismem

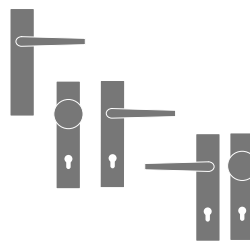

Klika/klika + plné štítky

Koule/klika R + štítky cylindrické

Koule/klika L + štítky cylindrické



dozické

cylindrické

WC in

WC ex

plný štít

s koulí Kemer

konstrukční varianty, materiálové provedení

- kování s vratnou pružinou
- kovový vnitřní štít
- nacvakávací krycí mosazný štít
- montáž na dveře do tl. 126 mm
- záruka 3 roky, titany 15 let

roky **3 garance** let **15 garance**

- kování s vratnou pružinou
- masivní mosazný štít
- montáž na dveře do tl. 126 mm
- záruka 3 roky, titany 15 let

roky **3 garance** let **15 garance**

Ochranná známka – registrovaná značka **ENTERO®**

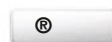

Chráněné průmyslové vzory klik



**ENTERO**  
**BURAK**  
**MIA**  
**SOGUT**



SNi matný nikel

**Garanti**

2060,- Kč  
86,- EUR



Ms mosaz natural

**Sogut**

2360,- Kč  
99,- EUR



**Deny**

2150,- Kč  
90,- EUR



**Kč** materiál: masivní mosaz  
povrch: SNi matný nikel **EUR**

2060,-				86,-
2060,-				86,-
2670,-				112,-
2790,-				117,-
2790,-				117,-

2060,-				86,-
2060,-				86,-
2670,-				112,-
2790,-				117,-
2790,-				117,-
2400,-				100,-

2360,-				99,-
2360,-				99,-
3070,-				128,-
3120,-				130,-
3120,-				130,-

2360,-				99,-
2360,-				99,-
3070,-				128,-
3120,-				130,-
3120,-				130,-
2680,-				112,-

2150,-				90,-
2150,-				90,-
2890,-				121,-
2900,-				121,-
2900,-				121,-

2150,-				90,-
2150,-				90,-
2890,-				121,-
2900,-				121,-
2900,-				121,-
2500,-				105,-

Orientace WC:  
WC in je namontované automaticky u pravé kliky R.  
Požadovanou jinou orientaci WC je nutno upřesnit.





	SNI			Cr			Ms			Ms-L			TiN-C			TiN-K		
		cena / pár	EAN	cena / pár	EAN	cena / pár	EAN	cena / pár	EAN	cena / pár	EAN	cena / pár	EAN	cena / pár	EAN			
<b>72 mm</b>																		
dozický	Kč €	2060,- 86,-	27305	2610,- 109,-	27398	2610,- 109,-	055450	2610,- 109,-	055504	2890,- 121,-	39919	3850,- 161,-	39964					
cyldrický	Kč €	2060,- 86,-	27312	2610,- 109,-	27404	2610,- 109,-	055467	2610,- 109,-	055511	2890,- 121,-	39926	3850,- 161,-	39971					
WC	Kč €	2670,- 112,-	27329	3210,- 134,-	27411	3210,- 134,-	055474	3210,- 134,-	055528	3560,- 149,-	39933	4810,- 201,-	39988					
koule / klika R	Kč €	2790,- 117,-	27336	3320,- 139,-	27428	3320,- 139,-	055481	3320,- 139,-	055535	3950,- 165,-	39940	4930,- 206,-	39995					
koule / klika L	Kč €	2790,- 117,-	27343	3320,- 139,-	27435	3320,- 139,-	055498	3320,- 139,-	055542	3950,- 165,-	39957	4930,- 206,-	40106					
<b>90 mm</b>																		
dozický	Kč €	2060,- 86,-	27350	2610,- 109,-	27442	2610,- 109,-	055559	2610,- 109,-	055610	2890,- 121,-	40205	3850,- 161,-	40243					
cyldrický	Kč €	2060,- 86,-	27367	2610,- 109,-	27459	2610,- 109,-	055566	2610,- 109,-	055627	2890,- 121,-	40212	3850,- 161,-	40250					
WC	Kč €	2670,- 112,-	40328	3210,- 134,-	40342	3210,- 134,-	055573	3210,- 134,-	055634	3560,- 149,-	40380	4810,- 201,-	40403					
koule / klika R	Kč €	2790,- 117,-	27374	3320,- 139,-	27466	3320,- 139,-	055580	3320,- 139,-	055641	3950,- 165,-	40229	4930,- 206,-	40267					
koule / klika L	Kč €	2790,- 117,-	27381	3320,- 139,-	27473	3320,- 139,-	055597	3320,- 139,-	055658	3950,- 165,-	40236	4930,- 206,-	40274					
plný štítek	Kč €	2400,- 100,-	40335	2930,- 123,-	40359	2930,- 123,-	055603	2930,- 123,-	055665	3160,- 132,-	40397	4190,- 175,-	40410					
<b>72 mm</b>																		
dozický	Kč €	2360,- 99,-	24670	2900,- 121,-	33863	2900,- 121,-	055672	2900,- 121,-	055726	3200,- 134,-	33917	4150,- 173,-	24854					
cyldrický	Kč €	2360,- 99,-	24687	2900,- 121,-	33870	2900,- 121,-	055689	2900,- 121,-	055733	3200,- 134,-	33924	4150,- 173,-	24861					
WC	Kč €	3070,- 128,-	24694	3620,- 151,-	33887	3620,- 151,-	055696	3620,- 151,-	055740	4020,- 168,-	33931	5230,- 218,-	24878					
koule / klika R	Kč €	3120,- 130,-	24700	3650,- 153,-	33894	3650,- 153,-	055702	3650,- 153,-	055757	4310,- 180,-	33948	5260,- 220,-	24885					
koule / klika L	Kč €	3120,- 130,-	24717	3650,- 153,-	33900	3650,- 153,-	055719	3650,- 153,-	055764	4310,- 180,-	33955	5260,- 220,-	24892					
<b>90 mm</b>																		
dozický	Kč €	2360,- 99,-	24632	2900,- 121,-	33962	2900,- 121,-	055771	2900,- 121,-	055832	3200,- 134,-	34006	4150,- 173,-	24816					
cyldrický	Kč €	2360,- 99,-	24649	2900,- 121,-	33979	2900,- 121,-	055788	2900,- 121,-	055849	3200,- 134,-	34013	4150,- 173,-	24823					
WC	Kč €	3070,- 128,-	37526	3620,- 151,-	37540	3620,- 151,-	055795	3620,- 151,-	055856	4020,- 168,-	37588	5230,- 218,-	37601					
koule / klika R	Kč €	3120,- 130,-	24656	3650,- 153,-	33986	3650,- 153,-	055801	3650,- 153,-	055863	4310,- 180,-	34020	5260,- 220,-	24830					
koule / klika L	Kč €	3120,- 130,-	24663	3650,- 153,-	33993	3650,- 153,-	055818	3650,- 153,-	055870	4310,- 180,-	34037	5260,- 220,-	24847					
plný štítek	Kč €	2680,- 112,-	37533	3220,- 135,-	37557	3220,- 135,-	055825	3220,- 135,-	055887	3510,- 147,-	37595	4480,- 187,-	37618					
<b>72 mm</b>																		
dozický	Kč €	2150,- 90,-	24946	2680,- 112,-	25196	2680,- 112,-	055894	2680,- 112,-	055948	2990,- 125,-	33498	3940,- 165,-	33542					
cyldrický	Kč €	2150,- 90,-	24953	2680,- 112,-	25202	2680,- 112,-	055900	2680,- 112,-	055955	2990,- 125,-	33504	3940,- 165,-	33559					
WC	Kč €	2890,- 121,-	24960	3420,- 143,-	25219	3420,- 143,-	055917	3420,- 143,-	055962	3810,- 159,-	33511	5030,- 210,-	33566					
koule / klika R	Kč €	2900,- 121,-	24977	3430,- 143,-	25226	3430,- 143,-	055924	3430,- 143,-	055979	4130,- 173,-	33528	5040,- 210,-	33573					
koule / klika L	Kč €	2900,- 121,-	24984	3430,- 143,-	25233	3430,- 143,-	055931	3430,- 143,-	055986	4130,- 173,-	33535	5040,- 210,-	33580					
<b>90 mm</b>																		
dozický	Kč €	2150,- 90,-	24908	2680,- 112,-	25158	2680,- 112,-	055993	2680,- 112,-	056051	2990,- 125,-	34082	3940,- 165,-	34129					
cyldrický	Kč €	2150,- 90,-	24915	2680,- 112,-	25165	2680,- 112,-	056006	2680,- 112,-	056068	2990,- 125,-	34099	3940,- 165,-	34136					
WC	Kč €	2890,- 121,-	39742	3420,- 143,-	39766	3420,- 143,-	056013	3420,- 143,-	056075	3810,- 159,-	39803	5030,- 210,-	39827					
koule / klika R	Kč €	2900,- 121,-	24922	3430,- 143,-	25172	3430,- 143,-	056020	3430,- 143,-	056082	4130,- 173,-	34105	5040,- 210,-	34143					
koule / klika L	Kč €	2900,- 121,-	24939	3430,- 143,-	25189	3430,- 143,-	056037	3430,- 143,-	056099	4130,- 173,-	34112	5040,- 210,-	34150					
plný štítek	Kč €	2500,- 105,-	39759	3030,- 127,-	39773	3030,- 127,-	056044	3030,- 127,-	056105	3300,- 138,-	39810	4280,- 179,-	39834					

Zakázkově možnost sešroubování pomocí sešroubovacích pouzder skrze dveřní křídlo u modelů Burak, Cesan, Meclis, viz. Příslušenství a komponenty str. 369.

Standardně dodáváno s pevnou koulí Kemer, na základě požadavků s pevnou koulí Maty. Lze dodat s otočnou koulí Fábi (mimo štítoých modelů Burak, Cesan, Meclis).



**Lusy**

2150,- Kč  
90,- EUR

SNi matný nikl



**Andy**

2360,- Kč  
99,- EUR



Ms mosaz natural



**Entero**

3900,- Kč  
163,- EUR

**KČ** materiál: masivní mosaz  
povrch: SNi matný nikl **EUR**

2150,-		90,-
2150,-		90,-
2890,-		121,-
2900,-		121,-
2900,-		121,-
2150,-		90,-
2150,-		90,-
2890,-		121,-
2900,-		121,-
2900,-		121,-
2500,-		105,-
2360,-		99,-
2360,-		99,-
3060,-		128,-
3120,-		130,-
3120,-		130,-
2360,-		99,-
2360,-		99,-
3060,-		128,-
3120,-		130,-
3120,-		130,-
2680,-		112,-
3900,-		163,-
3900,-		163,-
4530,-		189,-
4540,-		190,-
4540,-		190,-
3900,-		163,-
3900,-		163,-
4530,-		189,-
4540,-		190,-
4540,-		190,-
4150,-		173,-

Orientace WC:  
WC in je namontované automaticky u pravé kliky R.  
Požadovanou jinou orientaci WC je nutno upřesnit.



	SNI			Cr			Ms			Ms-L			TiN-C		TiN-K	
		cena / pár	EAN	cena / pár	EAN	cena / pár	EAN	cena / pár	EAN	cena / pár	EAN	cena / pár	EAN	cena / pár	EAN	
<b>72 mm</b>																
dozický	Kč €	2150,- 90,-	24496	2680,- 112,-	24588	2680,- 112,-	056112	2680,- 112,-	056167	2990,- 125,-	33641	3940,- 165,-	33696			
cyldrický	Kč €	2150,- 90,-	24502	2680,- 112,-	24595	2680,- 112,-	056129	2680,- 112,-	056174	2990,- 125,-	33658	3940,- 165,-	33702			
WC	Kč €	2890,- 121,-	24519	3420,- 143,-	24601	3420,- 143,-	056136	3420,- 143,-	056181	3810,- 159,-	33665	5030,- 210,-	33719			
koule / klika R	Kč €	2900,- 121,-	24526	3430,- 143,-	24618	3430,- 143,-	056143	3430,- 143,-	056198	4130,- 173,-	33672	5040,- 210,-	33726			
koule / klika L	Kč €	2900,- 121,-	24533	3430,- 143,-	24625	3430,- 143,-	056150	3430,- 143,-	056204	4130,- 173,-	33689	5040,- 210,-	33733			
<b>90 mm</b>																
dozický	Kč €	2150,- 90,-	24458	2680,- 112,-	24540	2680,- 112,-	056211	2680,- 112,-	056273	2990,- 125,-	33788	3940,- 165,-	33825			
cyldrický	Kč €	2150,- 90,-	24465	2680,- 112,-	24557	2680,- 112,-	056228	2680,- 112,-	056280	2990,- 125,-	33795	3940,- 165,-	33832			
WC	Kč €	2890,- 121,-	39384	3420,- 143,-	39407	3420,- 143,-	056235	3420,- 143,-	056297	3810,- 159,-	39445	5030,- 210,-	39469			
koule / klika R	Kč €	2900,- 121,-	24472	3430,- 143,-	24564	3430,- 143,-	056242	3430,- 143,-	056303	4130,- 173,-	33801	5040,- 210,-	33849			
koule / klika L	Kč €	2900,- 121,-	24489	3430,- 143,-	24571	3430,- 143,-	056259	3430,- 143,-	056310	4130,- 173,-	33818	5040,- 210,-	33856			
plný štítek	Kč €	2500,- 105,-	39391	3030,- 127,-	39414	3030,- 127,-	056266	3030,- 127,-	056327	3300,- 138,-	39452	4280,- 179,-	39476			
<b>72 mm</b>																
dozický	Kč €	2360,- 99,-	40441	2900,- 121,-	40496	2900,- 121,-	056334	2900,- 121,-	056389	3200,- 134,-	40595	4150,- 173,-	40649			
cyldrický	Kč €	2360,- 99,-	40458	2900,- 121,-	40502	2900,- 121,-	056341	2900,- 121,-	056396	3200,- 134,-	40601	4150,- 173,-	40656			
WC	Kč €	3060,- 128,-	40465	3600,- 150,-	40519	3600,- 150,-	056358	3600,- 150,-	056402	4080,- 170,-	40618	5210,- 218,-	40663			
koule / klika R	Kč €	3120,- 130,-	40472	3650,- 153,-	40526	3650,- 153,-	056365	3650,- 153,-	056419	4310,- 180,-	40625	5260,- 220,-	40670			
koule / klika L	Kč €	3120,- 130,-	40489	3650,- 152,-	40533	3650,- 153,-	056372	3650,- 153,-	056426	4310,- 180,-	40632	5260,- 220,-	40687			
<b>90 mm</b>																
dozický	Kč €	2360,- 99,-	40748	2900,- 121,-	40786	2900,- 121,-	056433	2900,- 121,-	056495	3200,- 134,-	40861	4150,- 173,-	40908			
cyldrický	Kč €	2360,- 99,-	40755	2900,- 121,-	40793	2900,- 121,-	056440	2900,- 121,-	056501	3200,- 134,-	40878	4150,- 173,-	40915			
WC	Kč €	3060,- 128,-	40984	3600,- 150,-	41004	3600,- 150,-	056457	3600,- 150,-	056518	4080,- 170,-	41042	5210,- 218,-	41066			
koule / klika R	Kč €	3120,- 130,-	40762	3650,- 153,-	40809	3650,- 153,-	056464	3650,- 153,-	056525	4310,- 180,-	40885	5260,- 220,-	40922			
koule / klika L	Kč €	3120,- 130,-	40779	3650,- 153,-	40816	3650,- 153,-	056471	3650,- 153,-	056532	4310,- 180,-	40892	5260,- 220,-	40939			
plný štítek	Kč €	2680,- 112,-	40991	3220,- 135,-	41011	3220,- 135,-	056488	3220,- 135,-	056549	3510,- 147,-	41059	4480,- 187,-	41073			
<b>72 mm</b>																
dozický	Kč €	3900,- 163,-	75412	4440,- 185,-	75467	4440,- 185,-	056556	4440,- 185,-	056600	4700,- 196,-	75566	5690,- 238,-	75610			
cyldrický	Kč €	3900,- 163,-	75429	4440,- 185,-	75474	4440,- 185,-	056563	4440,- 185,-	056617	4700,- 196,-	75573	5690,- 238,-	75627			
WC	Kč €	4530,- 189,-	75436	5070,- 212,-	75481	5070,- 212,-	056570	5070,- 212,-	056624	5440,- 227,-	75580	6690,- 279,-	75634			
koule / klika R	Kč €	4540,- 190,-	75443	5080,- 212,-	75498	5080,- 212,-	056587	5080,- 212,-	056631	5720,- 239,-	75597	6700,- 280,-	75641			
koule / klika L	Kč €	4540,- 190,-	75450	5080,- 212,-	75504	5080,- 212,-	056594	5080,- 212,-	056648	5720,- 239,-	75603	6700,- 280,-	75658			
<b>90 mm</b>																
dozický	Kč €	3900,- 163,-	75665	4440,- 185,-	75726	4440,- 185,-	056655	4440,- 185,-	056716	4700,- 196,-	75849	5690,- 238,-	75900			
cyldrický	Kč €	3900,- 163,-	75672	4440,- 185,-	75733	4440,- 185,-	056662	4440,- 185,-	056723	4700,- 196,-	75856	5690,- 238,-	75917			
WC	Kč €	4530,- 189,-	75689	5070,- 212,-	75740	5070,- 212,-	056679	5070,- 212,-	056730	5440,- 227,-	75863	6690,- 279,-	75924			
koule / klika R	Kč €	4540,- 190,-	75696	5080,- 212,-	75757	5080,- 212,-	056686	5080,- 212,-	056747	5720,- 239,-	75870	6700,- 280,-	75931			
koule / klika L	Kč €	4540,- 190,-	75702	5080,- 212,-	75764	5080,- 212,-	056693	5080,- 212,-	056754	5720,- 239,-	75887	6700,- 280,-	75948			
plný štítek	Kč €	4150,- 173,-	75719	4700,- 196,-	75771	4700,- 196,-	056709	4700,- 196,-	056761	4970,- 208,-	75894	5930,- 248,-	75955			

Zakázkově možnost sešroubování pomocí sešroubovacích pouzder skrze dveřní křídlo u modelů Burak, Cesan, Meclis, viz. Příslušenství a komponenty str. 369.  
Standardně dodáváno s pevnou koulí Kemer, na základě požadavků s pevnou koulí Maty. Lze dodat s otočnou koulí Fábi (mimo štítoých modelů Burak, Cesan, Meclis).



SNi matný nikel



**Mondeo**

2800,- Kč  
117,- EUR

**Cherez**

3070,- Kč  
128,- EUR

**Burak**

1940,- Kč  
81,- EUR

**KČ** materiál: masivní mosaz  
povrch: SNi matný nikel **EUR**

2800,-		117,-
2800,-		117,-
3480,-		145,-
3510,-		147,-
3510,-		147,-
2800,-		117,-
2800,-		117,-
3480,-		145,-
3510,-		147,-
3510,-		147,-
3120,-		130,-
3070,-		128,-
3070,-		128,-
3740,-		156,-
3750,-		157,-
3750,-		157,-
3070,-		128,-
3070,-		128,-
3740,-		156,-
3750,-		157,-
3750,-		157,-
3390,-		142,-
1940,-		81,-
1940,-		81,-
2560,-		107,-
2680,-		112,-
2680,-		112,-
1940,-		81,-
1940,-		81,-
2560,-		107,-
2680,-		112,-
2680,-		112,-
2270,-		95,-

Orientace WC:  
WC in je namontované automaticky u pravé kliky R.  
Požadovanou jinou orientaci WC je nutno upřesnit.



		Sni		Cr		Ms		Ms-L		TiN-C		TiN-K	
		cena / pár	EAN	cena / pár	EAN	cena / pár	EAN	cena / pár	EAN	cena / pár	EAN	cena / pár	EAN
<b>72 mm</b>													
dozický	Kč €	2800,- 117,-	41769	3330,- 139,-	41813	3330,- 139,-	056778	3330,- 139,-	056822	3650,- 153,-	41912	4580,- 191,-	41967
cyklindrický	Kč €	2800,- 117,-	41776	3330,- 139,-	41820	3330,- 139,-	056785	3330,- 139,-	056839	3650,- 153,-	41929	4580,- 191,-	41974
WC	Kč €	3480,- 145,-	41783	4010,- 168,-	41837	4010,- 168,-	056792	4010,- 168,-	056846	4490,- 188,-	41936	5620,- 235,-	41981
koule / klika R	Kč €	3510,- 147,-	41790	4040,- 169,-	41844	4040,- 169,-	056808	4040,- 169,-	056853	4730,- 198,-	41943	5670,- 237,-	41998
koule / klika L	Kč €	3510,- 147,-	41806	4040,- 169,-	41851	4040,- 169,-	056815	4040,- 169,-	056860	4730,- 198,-	41950	5670,- 237,-	42001
<b>90 mm</b>													
dozický	Kč €	2800,- 117,-	42063	3330,- 139,-	42100	3330,- 139,-	056877	3330,- 139,-	056938	3650,- 153,-	42186	4580,- 191,-	42223
cyklindrický	Kč €	2800,- 117,-	42070	3330,- 139,-	42117	3330,- 139,-	056884	3330,- 139,-	056945	3650,- 153,-	42193	4580,- 191,-	42230
WC	Kč €	3480,- 145,-	42308	4010,- 168,-	42322	4010,- 168,-	056891	4010,- 168,-	056952	4490,- 188,-	42360	5620,- 235,-	42384
koule / klika R	Kč €	3510,- 147,-	42087	4040,- 169,-	42124	4040,- 169,-	056907	4040,- 169,-	056969	4730,- 198,-	42209	5670,- 237,-	42247
koule / klika L	Kč €	3510,- 147,-	42094	4040,- 169,-	42131	4040,- 169,-	056914	4040,- 169,-	056976	4730,- 198,-	42216	5670,- 237,-	42254
plný štítek	Kč €	3120,- 130,-	42315	3650,- 153,-	42339	3650,- 153,-	056921	3650,- 153,-	056983	3930,- 164,-	42377	4900,- 205,-	42391
<b>72 mm</b>													
dozický	Kč €	3070,- 128,-	74750	3620,- 151,-	74804	3620,- 151,-	056990	3620,- 151,-	057041	3900,- 163,-	74903	4850,- 203,-	74958
cyklindrický	Kč €	3070,- 128,-	74767	3620,- 151,-	74811	3620,- 151,-	057003	3620,- 151,-	057058	3900,- 163,-	74910	4850,- 203,-	74965
WC	Kč €	3740,- 156,-	74774	4280,- 179,-	74828	4280,- 179,-	057010	4280,- 179,-	057065	4670,- 195,-	74927	5890,- 246,-	74972
koule / klika R	Kč €	3750,- 157,-	74781	4290,- 179,-	74835	4290,- 179,-	057027	4290,- 179,-	057072	4970,- 208,-	74934	5900,- 246,-	74989
koule / klika L	Kč €	3750,- 157,-	74798	4290,- 179,-	74842	4290,- 179,-	057034	4290,- 179,-	057089	4970,- 208,-	74941	5900,- 246,-	74996
<b>90 mm</b>													
dozický	Kč €	3070,- 128,-	75054	3620,- 151,-	75115	3620,- 151,-	057096	3620,- 151,-	057157	3900,- 163,-	75238	4850,- 203,-	75290
cyklindrický	Kč €	3070,- 128,-	75061	3620,- 151,-	75122	3620,- 151,-	057102	3620,- 151,-	057164	3900,- 163,-	75245	4850,- 203,-	75306
WC	Kč €	3740,- 156,-	75078	4280,- 179,-	75139	4280,- 179,-	057119	4280,- 179,-	057171	4670,- 195,-	75252	5890,- 246,-	75313
koule / klika R	Kč €	3750,- 157,-	75085	4290,- 179,-	75146	4290,- 179,-	057126	4290,- 179,-	057188	4970,- 208,-	75269	5900,- 246,-	75320
koule / klika L	Kč €	3750,- 157,-	75092	4290,- 179,-	75153	4290,- 179,-	057133	4290,- 179,-	057195	4970,- 208,-	75276	5900,- 246,-	75337
plný štítek	Kč €	3390,- 142,-	75108	3920,- 164,-	75160	3920,- 164,-	057140	3920,- 164,-	057201	4150,- 173,-	75283	5170,- 216,-	75344
<b>72 mm</b>													
dozický	Kč €	1940,- 81,-	70820	2460,- 103,-	70875	2460,- 103,-	057218	2460,- 103,-	057263	2800,- 117,-	70974	3730,- 156,-	71025
cyklindrický	Kč €	1940,- 81,-	70837	2460,- 103,-	70882	2460,- 103,-	057225	2460,- 103,-	057270	2800,- 117,-	70981	3730,- 156,-	71032
WC	Kč €	2560,- 107,-	70844	3120,- 130,-	70899	3120,- 130,-	057232	3120,- 130,-	057287	3510,- 147,-	70998	4720,- 197,-	71049
koule / klika R	Kč €	2680,- 112,-	70851	3220,- 135,-	70905	3220,- 135,-	057249	3220,- 135,-	057294	3930,- 164,-	71001	4830,- 202,-	71056
koule / klika L	Kč €	2680,- 112,-	70868	3220,- 135,-	70912	3220,- 135,-	057256	3220,- 135,-	057300	3930,- 164,-	71018	4830,- 202,-	71063
<b>90 mm</b>													
dozický	Kč €	1940,- 81,-	71124	2460,- 103,-	71186	2460,- 103,-	057317	2460,- 103,-	057379	2800,- 117,-	71308	3730,- 156,-	71360
cyklindrický	Kč €	1940,- 81,-	71131	2460,- 103,-	71193	2460,- 103,-	057324	2460,- 103,-	057386	2800,- 117,-	71315	3730,- 156,-	71377
WC	Kč €	2560,- 107,-	71148	3120,- 130,-	71209	3120,- 130,-	057331	3120,- 130,-	057393	3510,- 147,-	71322	4720,- 197,-	71384
koule / klika R	Kč €	2680,- 112,-	71155	3220,- 135,-	71216	3220,- 135,-	057348	3220,- 135,-	057409	3930,- 164,-	71339	4830,- 202,-	71391
koule / klika L	Kč €	2680,- 112,-	71162	3220,- 135,-	71223	3220,- 135,-	057355	3220,- 135,-	057416	3930,- 164,-	71346	4830,- 202,-	71407
plný štítek	Kč €	2270,- 95,-	71179	2810,- 118,-	71230	2810,- 118,-	057362	2810,- 118,-	057423	3120,- 130,-	71353	4050,- 169,-	71414

Zakázkově možnost sešroubování pomocí sešroubovacích pouzder skrze dveřní křídlo u modelů Burak, Cesan, Meclis, viz. Příslušenství a komponenty str. 369.  
Standardně dodáváno s pevnou koulí Kemer, na základě požadavků s pevnou koulí Maty. Lze dodat s otočnou koulí Fábi (mimo štítoých modelů Burak, Cesan, Meclis).



SNi matný nikl



Ms mosaz natural

**Mia**

2150,- Kč  
90,- EUR



**Meclis**

x,- Kč  
x,- EUR



**Cesan**

1680,- Kč  
70,- EUR

**KČ** materiál: masivní mosaz povrch: SNi matný nikl **EUR**

2150,-		90,-
2150,-		90,-
2890,-		121,-
2900,-		121,-
2900,-		121,-

2150,-		90,-
2150,-		90,-
2890,-		121,-
2900,-		121,-
2900,-		121,-
2500,-		105,-

1940,-		81,-
1940,-		81,-
2560,-		107,-
2680,-		112,-
2680,-		112,-

1940,-		81,-
1940,-		81,-
2560,-		107,-
2680,-		112,-
2680,-		112,-
2270,-		95,-

1680,-		70,-
1680,-		70,-
2270,-		95,-
2400,-		100,-
2400,-		100,-

1680,-		70,-
1680,-		70,-
2270,-		95,-
2400,-		100,-
2400,-		100,-
1980,-		83,-

Orientace WC:  
WC in je namontované automaticky u pravé kliky R.  
Požadovanou jinou orientaci WC je nutno upřesnit.



	SNI			Cr			Ms			Ms-L			TiN-C			TiN-K		
		cena / pár	EAN	cena / pár	EAN	cena / pár	EAN	cena / pár	EAN	cena / pár	EAN	cena / pár	EAN	cena / pár	EAN			
<b>72 mm</b>																		
dozický	Kč €	2150,- 90,-	38127	2680,- 112,-	38172	2680,- 112,-	057430	2680,- 112,-	057485	2990,- 125,-	38271	3940,- 165,-	38325					
cyldrický	Kč €	2150,- 90,-	38134	2680,- 112,-	38189	2680,- 112,-	057447	2680,- 112,-	057492	2990,- 125,-	38288	3940,- 165,-	38332					
WC	Kč €	2890,- 121,-	38141	3420,- 143,-	38196	3420,- 143,-	057454	3420,- 143,-	057508	3810,- 159,-	38295	5030,- 210,-	38349					
koule / klika R	Kč €	2900,- 121,-	38158	3430,- 143,-	38202	3430,- 143,-	057461	3430,- 143,-	057515	4130,- 173,-	38301	5040,- 210,-	38356					
koule / klika L	Kč €	2900,- 121,-	38165	3430,- 143,-	38219	3430,- 143,-	057478	3430,- 143,-	057522	4130,- 173,-	38318	5040,- 210,-	38363					
<b>90 mm</b>																		
dozický	Kč €	2150,- 90,-	38424	2680,- 112,-	38462	2680,- 112,-	057539	2680,- 112,-	057591	2990,- 125,-	38547	3940,- 165,-	38585					
cyldrický	Kč €	2150,- 90,-	38431	2680,- 112,-	38479	2680,- 112,-	057546	2680,- 112,-	057607	2990,- 125,-	38554	3940,- 165,-	38592					
WC	Kč €	2890,- 121,-	39506	3420,- 143,-	39520	3420,- 143,-	057553	3420,- 143,-	057614	3810,- 159,-	39568	5030,- 210,-	39582					
koule / klika R	Kč €	2900,- 121,-	38448	3430,- 143,-	38486	3430,- 143,-	057560	3430,- 143,-	057621	4130,- 173,-	38561	5040,- 210,-	38608					
koule / klika L	Kč €	2900,- 121,-	38455	3430,- 143,-	38493	3430,- 143,-	057577	3430,- 143,-	057638	4130,- 173,-	38578	5040,- 210,-	38615					
plný štítek	Kč €	2500,- 105,-	39513	3030,- 127,-	39537	3030,- 127,-	057584	3030,- 127,-	057645	3300,- 138,-	39575	4280,- 179,-	39599					
<b>72 mm</b>																		
dozický	Kč €	1940,- 81,-	24311	2460,- 103,-	24403	2460,- 103,-	057652	2460,- 103,-	057706	2800,- 117,-	33221	3730,- 156,-	33276					
cyldrický	Kč €	1940,- 81,-	24328	2460,- 103,-	24410	2460,- 103,-	057669	2460,- 103,-	057713	2800,- 117,-	33238	3730,- 156,-	33283					
WC	Kč €	2560,- 107,-	24335	3120,- 130,-	24427	3120,- 130,-	057676	3120,- 130,-	057720	3510,- 147,-	33245	4720,- 197,-	33290					
koule / klika R	Kč €	2680,- 112,-	24342	3220,- 135,-	24434	3220,- 135,-	057683	3220,- 135,-	057737	3930,- 164,-	33252	4830,- 202,-	33306					
koule / klika L	Kč €	2680,- 112,-	24359	3220,- 135,-	24441	3220,- 135,-	057690	3220,- 135,-	057744	3930,- 164,-	33269	4830,- 202,-	33313					
<b>90 mm</b>																		
dozický	Kč €	1940,- 81,-	24274	2460,- 103,-	24366	2460,- 103,-	057751	2460,- 103,-	057812	2800,- 117,-	33368	3730,- 156,-	33405					
cyldrický	Kč €	1940,- 81,-	24281	2460,- 103,-	24373	2460,- 103,-	057768	2460,- 103,-	057829	2800,- 117,-	33375	3730,- 156,-	33412					
WC	Kč €	2560,- 107,-	42513	3120,- 130,-	42537	3120,- 130,-	057775	3120,- 130,-	057836	3510,- 147,-	42575	4720,- 197,-	42599					
koule / klika R	Kč €	2680,- 112,-	24298	3220,- 135,-	24380	3220,- 135,-	057782	3220,- 135,-	057843	3930,- 164,-	33382	4830,- 202,-	33429					
koule / klika L	Kč €	2680,- 112,-	24304	3220,- 135,-	24397	3220,- 135,-	057799	3220,- 135,-	057850	3930,- 164,-	33399	4830,- 202,-	33436					
plný štítek	Kč €	2270,- 95,-	42520	2810,- 118,-	42544	2810,- 118,-	057805	2810,- 118,-	057867	3120,- 130,-	42582	4050,- 169,-	42605					
<b>72 mm</b>																		
dozický	Kč €	1680,- 70,-	71483	2220,- 93,-	71537	2220,- 93,-	057874	2220,- 93,-	057928	2460,- 103,-	71636	3460,- 145,-	71681					
cyldrický	Kč €	1680,- 70,-	71490	2220,- 93,-	71544	2220,- 93,-	057881	2220,- 93,-	057935	2460,- 103,-	71643	3460,- 145,-	71698					
WC	Kč €	2270,- 95,-	71506	2810,- 118,-	71551	2810,- 118,-	057898	2810,- 118,-	057942	3160,- 132,-	71650	4440,- 185,-	71704					
koule / klika R	Kč €	2400,- 100,-	71513	2930,- 123,-	71568	2930,- 123,-	057904	2930,- 123,-	057959	3560,- 149,-	71667	4530,- 189,-	71711					
koule / klika L	Kč €	2400,- 100,-	71520	2930,- 123,-	71575	2930,- 123,-	057911	2930,- 123,-	057966	3560,- 149,-	71674	4530,- 189,-	71728					
<b>90 mm</b>																		
dozický	Kč €	1680,- 70,-	71780	2220,- 93,-	71841	2220,- 93,-	057973	2220,- 93,-	058031	2460,- 103,-	71964	3460,- 145,-	72022					
cyldrický	Kč €	1680,- 70,-	71797	2220,- 93,-	71858	2220,- 93,-	057980	2220,- 93,-	058048	2460,- 103,-	71971	3460,- 145,-	72039					
WC	Kč €	2270,- 95,-	71803	2810,- 118,-	71865	2810,- 118,-	057997	2810,- 118,-	058055	3160,- 132,-	71988	4440,- 185,-	72046					
koule / klika R	Kč €	2400,- 100,-	71810	2930,- 123,-	71872	2930,- 123,-	058000	2930,- 123,-	058062	3560,- 149,-	71995	4530,- 189,-	72053					
koule / klika L	Kč €	2400,- 100,-	71827	2930,- 123,-	71889	2930,- 123,-	058017	2930,- 123,-	058079	3560,- 149,-	72008	4530,- 189,-	72060					
plný štítek	Kč €	1980,- 83,-	71834	2530,- 106,-	71896	2530,- 106,-	058024	2530,- 106,-	058086	2790,- 117,-	72015	3760,- 157,-	72077					

Zakázkově možnost sešroubování pomocí sešroubovacích pouzder skrze dveřní křídlo u modelů Burak, Cesan, Meclis, viz. Příslušenství a komponenty str. 369.  
Standardně dodáváno s pevnou koulí Kemer, na základě požadavků s pevnou koulí Maty. Lze dodat s otočnou koulí Fábi (mimo štítových modelů Burak, Cesan, Meclis).



Příbuzný sortiment

Bezpečnostní vložky EVVA





## Bezpečnostní štítové kování

Materiál: masivní mosaz 

Povrchy: SNi, Cr, TiN-C, TiN-K, Ms, zakázkově TiN-S, TiN-A  
více info na [www.kliky-mt.cz/manufaktura/barvy-povrchy](http://www.kliky-mt.cz/manufaktura/barvy-povrchy)

Materiál: nerezová ocel

Povrchy: NRz nerez - broušeno, TiN-K

Bezpečnostní štíty M&T jsou připraveny pro všechny standardní projekty se širokou škálou použití. Předností je rozměrová variabilita pro běžné typy zámků s roztečí 72, 90 a 92 mm a barevnostní nabídka ve všech typech povrchů M&T. Kování Sicura lze kombinovat s jakoukoliv nerezovou klikou M&T a zároveň s jakoukoliv mosaznou klikou z produkce M&T.

SICURA **TiN-K** titan černý mat

SICURA **NRz** nerez broušeno

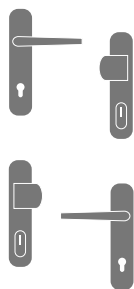

Madlo/klika R

Madlo/klika L

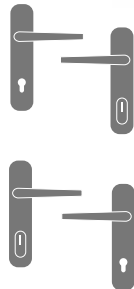

Klika/klika R

Klika/klika L

konstrukční varianty, materiálové provedení

- s krytkou cylindrické vložky
- z materiálů odolných proti rozlomení a vytržení
- maximální výstup cylindrické vložky z vnější strany max. 18 mm
- z vnitřní strany doporučený výstup 9 mm u štítů Sicura
- orientace kliky R pravá nebo L levá se určuje podle vnitřní kliky
- s montáží pro dveře 38 – 85 mm
- záruka 3 roky, nerez 5 let, titany 15 let

roky **3 garance** let **5 garance** let **15 garance**

Certifikace: bezpečnostní certifikáty státem akreditované zkušebny Trezor Test.

Certifikáty lze stáhnout na [www.kliky-mt.cz/certifikaty](http://www.kliky-mt.cz/certifikaty)



SNi matný nikel



**Bezpečnostní kování  
Burak Sicura**

5770,- Kč  
241,- EUR

**klika / klika**

**madlo / klika**

Kč	materiál: masivní mosaz povrch: SNi matný nikel	EUR
5770,-		241,-
5770,-		241,-
5770,-		241,-
5770,-		241,-
5770,-		241,-
5770,-		241,-
5770,-		241,-
5770,-		241,-
5770,-		241,-
5770,-		241,-
5770,-		241,-
5770,-		241,-
5770,-		241,-



**klika volitelná**



**Bezpečnostní kování  
Sicura**

6420,- Kč  
268,- EUR

**klika / klika  
volitelná**

**madlo / klika  
volitelná**

6420,-		268,-
6420,-		268,-
6420,-		268,-
6420,-		268,-
6420,-		268,-
6420,-		268,-
6420,-		268,-
6420,-		268,-
6420,-		268,-
6420,-		268,-
6420,-		268,-
6420,-		268,-
6420,-		268,-



		Sni		Cr		Ms		TiN-C		TiN-K	
		cena / pár	EAN	cena / pár	EAN	cena / pár	EAN	cena / pár	EAN	cena / pár	EAN
bezp. klika / klika R 72 mm	Kč €	5770,- 241,-	80614	5770,- 241,-	80676	5770,- 241,-	058093	6590,- 275,-	80799	6920,- 289,-	80850
bezp. klika / klika L 72 mm	Kč €	5770,- 241,-	80621	5770,- 241,-	80683	5770,- 241,-	058109	6590,- 275,-	80805	6920,- 289,-	80867
bezp. klika / klika R 90 mm	Kč €	5770,- 241,-	80638	5770,- 241,-	80690	5770,- 241,-	058116	6590,- 275,-	80812	6920,- 289,-	80874
bezp. klika / klika L 90 mm	Kč €	5770,- 241,-	80645	5770,- 241,-	80706	5770,- 241,-	058123	6590,- 275,-	80829	6920,- 289,-	80881
bezp. klika / klika R 92 mm	Kč €	5770,- 241,-	80652	5770,- 241,-	80713	5770,- 241,-	058130	6590,- 275,-	80836	6920,- 289,-	80898
bezp. klika / klika L 92 mm	Kč €	5770,- 241,-	80669	5770,- 241,-	80720	5770,- 241,-	058147	6590,- 275,-	80843	6920,- 289,-	80904
bezp. madlo / klika R 72 mm	Kč €	5770,- 241,-	80973	5770,- 241,-	81031	5770,- 241,-	058215	6590,- 275,-	81154	6920,- 289,-	81215
bezp. madlo / klika L 72 mm	Kč €	5770,- 241,-	80980	5770,- 241,-	81048	5770,- 241,-	058222	6590,- 275,-	81161	6920,- 289,-	81222
bezp. madlo / klika R 90 mm	Kč €	5770,- 241,-	80997	5770,- 241,-	81055	5770,- 241,-	058239	6590,- 275,-	81178	6920,- 289,-	81239
bezp. madlo / klika L 90 mm	Kč €	5770,- 241,-	81000	5770,- 241,-	81062	5770,- 241,-	058246	6590,- 275,-	81185	6920,- 289,-	81246
bezp. madlo / klika R 92 mm	Kč €	5770,- 241,-	81017	5770,- 241,-	81079	5770,- 241,-	058253	6590,- 275,-	81192	6920,- 289,-	81253
bezp. madlo / klika L 92 mm	Kč €	5770,- 241,-	81024	5770,- 241,-	81086	5770,- 241,-	058260	6590,- 275,-	81208	6920,- 289,-	81260



		Sni		Cr		Ms		TiN-C		TiN-K		NRz	
		cena / pár	EAN	cena / pár	EAN	cena / pár	EAN	cena / pár	EAN	cena / pár	EAN	cena / pár	EAN
bezp. klika / klika R 72 mm	Kč €	6420,- 268,-	82052	6420,- 268,-	82113	6420,- 268,-	058338	7240,- 302,-	82236	7580,- 316,-	82298	4230,- 177,-	080568
bezp. klika / klika L 72 mm	Kč €	6420,- 268,-	82069	6420,- 268,-	82120	6420,- 268,-	058345	7240,- 302,-	82243	7580,- 316,-	82304	4230,- 177,-	080575
bezp. klika / klika R 90 mm	Kč €	6420,- 268,-	82076	6420,- 268,-	82137	6420,- 268,-	058352	7240,- 302,-	82250	7580,- 316,-	82311	4230,- 177,-	080582
bezp. klika / klika L 90 mm	Kč €	6420,- 268,-	82083	6420,- 268,-	82144	6420,- 268,-	058369	7240,- 302,-	82267	7580,- 316,-	82328	4230,- 177,-	080599
bezp. klika / klika R 92 mm	Kč €	6420,- 268,-	82090	6420,- 268,-	82151	6420,- 268,-	058376	7240,- 302,-	82274	7580,- 316,-	82335	4230,- 177,-	080605
bezp. klika / klika L 92 mm	Kč €	6420,- 268,-	82106	6420,- 268,-	82168	6420,- 268,-	058383	7240,- 302,-	82281	7580,- 316,-	82342	4230,- 177,-	080612
bezp. madlo / klika R 72 mm	Kč €	6420,- 268,-	82410	6420,- 268,-	82472	6420,- 268,-	058451	7240,- 302,-	82595	7580,- 316,-	82656	4230,- 177,-	080629
bezp. madlo / klika L 72 mm	Kč €	6420,- 268,-	82427	6420,- 268,-	82489	6420,- 268,-	058468	7240,- 302,-	82601	7580,- 316,-	82663	4230,- 177,-	080636
bezp. madlo / klika R 90 mm	Kč €	6420,- 268,-	82434	6420,- 268,-	82496	6420,- 268,-	058475	7240,- 302,-	82618	7580,- 316,-	82670	4230,- 177,-	080643
bezp. madlo / klika L 90 mm	Kč €	6420,- 268,-	82441	6420,- 268,-	82502	6420,- 268,-	058482	7240,- 302,-	82625	7580,- 316,-	82687	4230,- 177,-	080650
bezp. madlo / klika R 92 mm	Kč €	6420,- 268,-	82458	6420,- 268,-	82519	6420,- 268,-	058499	7240,- 302,-	82632	7580,- 316,-	82694	4230,- 177,-	080667
bezp. madlo / klika L 92 mm	Kč €	6420,- 268,-	82465	6420,- 268,-	82526	6420,- 268,-	058505	7240,- 302,-	82649	7580,- 316,-	82700	4230,- 177,-	080674

Bezpečnostní kování Sicura je možné kombinovat s jakoukoliv rukojetí / klikou z produkce M&T včetně nerezových klik. Klika není s vratnou pružinou.

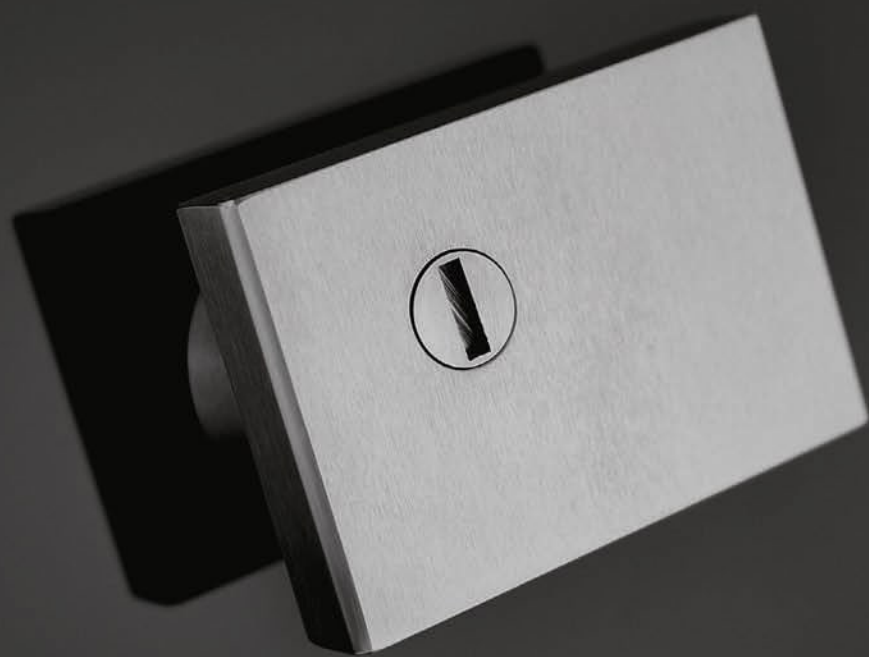

Příbuzný sortiment

Bezpečnostní vložky EVVA



**Jednostranné kliky**

DESIGN 2006  
DESIGN 2009  
DESIGN 2011  
DESIGN 2013  
Kování pro Al dveře

Příslušenství a komponenty  
Rozpěrný čtyřhran

## Bezpečnostní madla Entero s integrovanou rozetou

Materiál: nerezová ocel

Povrchy: NRz nerez - broušeno, K-industrial černý mat strukturovaný, TiN-C

Dveřní madla M&T s patentovaným inovativním řešením, kdy jsou veškeré potřebné funkce soustředěny do jednoho minimalistického funkčního celku. Bezpečnostní madlo Entero plní funkci jak ovládací – pomocí úchopné části madla, tak uzamykací – pomocí integrované rozety s požadovanou bezpečností. To vše na velmi malém prostoru, ale s maximální bezpečností a komfortem ovládání s důrazem na minimalistický design produktu. Pro různé typy dveří a pro různé požadavky na ovládání lze madla dodávat v individuálních délkách s možností povrchové titanové úpravy v žádaných barevných odstínech. Bezpečnostní madlo se dodává v kombinaci s rozetovým kováním z vnitřní strany dveří podle výběru z produkce M&T. Zcela komplexní řešení pro dokonale vzhled vstupních dveří.

Bezpečnostní madlo Entero **NRz** nerez ocel - broušeno

Bezpeč. madlo Entero 350 mm **K-industrial** černý mat strukturovaný

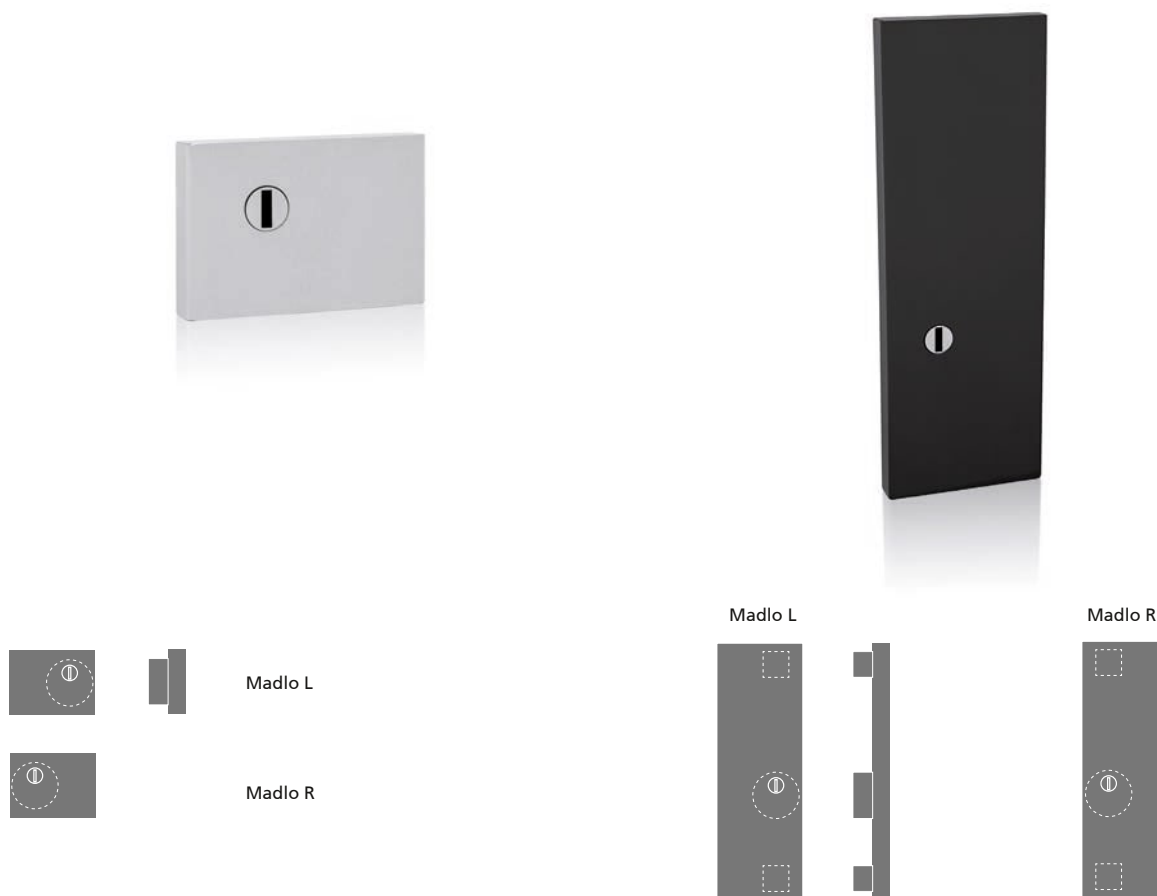

### konstrukční varianty, materiálové provedení

- s bezpečnostní krytkou cylindrické vložky
- maximální výstup cylindrické vložky z vnější strany dveří max. 37,5 mm
- doporučený výstup cylindrické vložky z vnitřní strany dveří 11 mm
- Bezpečnostní madlo se kombinuje s jednostrannou rozetovou klikou z produkce M&T
- montážně pro všechny typy zámků bez nutnosti určení rozměru/rozteče zámku
- zakázkově lze dodat madla až do délky 3000 mm v povrchu NRz, 2500 mm v povrchu K-industrial a 1000 mm v povrchu TiN-C
- madla od délky 350 mm se dodávají také oboustranné (do páru)
- madla jsou ve variantě R pravá, nebo L levá
- patentovaný konstrukční systém
- vrtání s PROFI šablonou M&T
- velmi rychlá a snadná montáž
- technické výkresy, výkresy vrtání na [www.kliky-mt.cz/montaze-kovani](http://www.kliky-mt.cz/montaze-kovani)
- montáž pro tloušťky dveří 38 – 126 mm
- záruka NRz, K-industrial 5 let, TiN-C 15 let

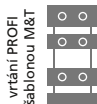

Ochranná známka – registrovaná značka

**ENTERO®**

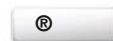

Chráněné průmyslové vzory



madlo **ENTERO**  
madlo **ENTERO 350**  
madlo **ENTERO 1000**

Patent

konstrukce systému



let **5 garance** let **15 garance**

Pro maximální bezpečnost doporučujeme kombinovat bezpečnostní madla Entero s cylindrickými vložkami EVVA.

Certifikace: bezpečnostní certifikáty státem akreditované zkušebny Trezor Test a NBÚ (Národní bezpečnostní úřad).

Certifikáty lze stáhnout na [www.kliky-mt.cz/katalog/bezpecnostni-madla-entero/](http://www.kliky-mt.cz/katalog/bezpecnostni-madla-entero/) u jednotlivých produktů.



NRz nerez - broušeno

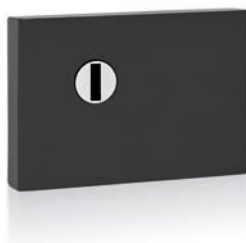

K-industrial černý mat strukturovaný

**Bezpečnostní madlo Entero**

6070,- Kč  
253,- EUR

materiál: nerezová ocel  
Kč povrch: NRz nerez - broušeno EUR

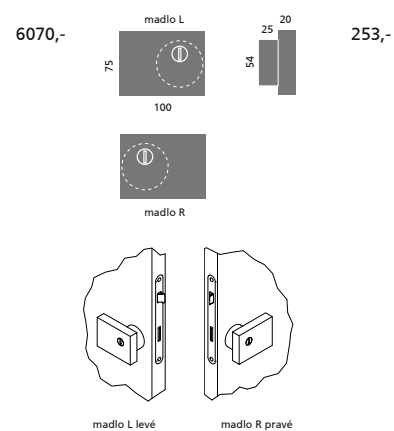

**Bezpečnostní madlo Entero 350 mm**

9160,- Kč  
382,- EUR

materiál: nerezová ocel  
Kč povrch: NRz nerez - broušeno EUR

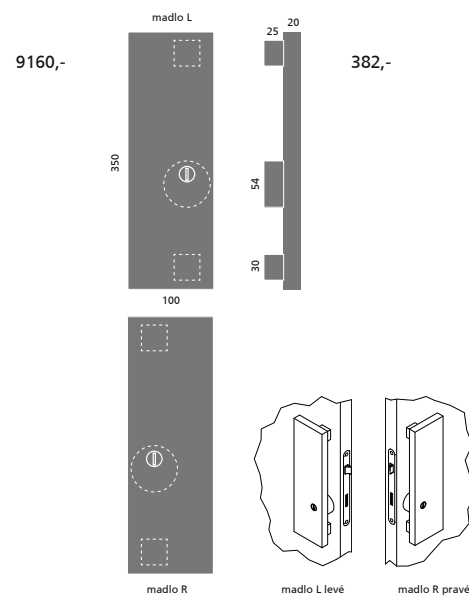

**Ochranné madlo Entero 350 mm pro Al dveře**

9160,- Kč  
382,- EUR

materiál: nerezová ocel  
Kč povrch: NRz nerez - broušeno EUR

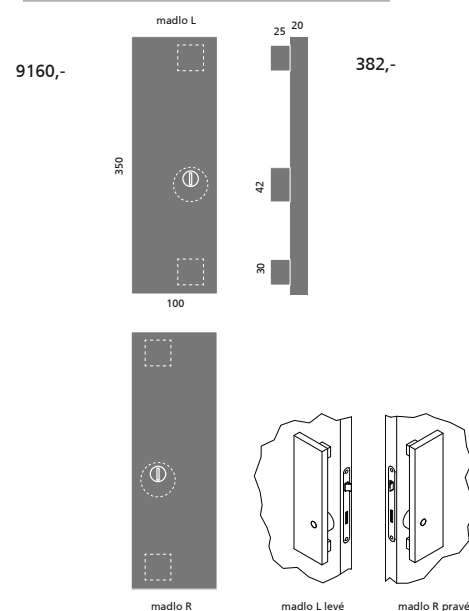

			NRz		TiN-C		K-industrial	
			cena	EAN	cena	EAN	cena	EAN
pro tl. dveří 38 - 45 mm	madlo L	Kč €	6070,- 253,-	035278	7280,- 304,-	035339	8690,- 363,-	035315
	madlo R	Kč €	6070,- 253,-	035285	7280,- 304,-	035346	8690,- 363,-	035322
pro tl. dveří 46 - 52 mm	madlo L	Kč €	6230,- 260,-	035353	7420,- 310,-	035414	8850,- 369,-	035391
	madlo R	Kč €	6230,- 260,-	035360	7420,- 310,-	035421	8850,- 369,-	035407
pro tl. dveří 52 - 60 mm	madlo L	Kč €	6390,- 267,-	035438	7590,- 317,-	035490	9000,- 375,-	035476
	madlo R	Kč €	6390,- 267,-	035445	7590,- 317,-	035506	9000,- 375,-	035483
pro tl. dveří 61 - 68 mm	madlo L	Kč €	6520,- 272,-	035513	7740,- 323,-	035575	9150,- 382,-	035551
	madlo R	Kč €	6520,- 272,-	035520	7740,- 323,-	035582	9150,- 382,-	035568
pro tl. dveří 69 - 126 mm	madlo L	Kč €	7160,- 299,-	035599	8370,- 349,-	035650	9780,- 408,-	035636
	madlo R	Kč €	7160,- 299,-	035605	8370,- 349,-	035667	9780,- 408,-	035643

U madel pro tl. dveří 69 mm a více je třeba specifikovat přesnou tloušťku dveří. Integrovaná bezpečnostní rozeta má průměr 54 mm. Černá nerezová madla se dodávají v novém hrubém povrchu s označením K-industrial.

			NRz		TiN-C		K-industrial	
			cena	EAN	cena	EAN	cena	EAN
pro tl. dveří 38 - 45 mm	madlo L	Kč €	9160,- 382,-	035674	10720,- 447,-	035711	12130,- 506,-	035698
	madlo R	Kč €	9160,- 382,-	035681	10720,- 447,-	035728	12130,- 506,-	035704
pro tl. dveří 46 - 52 mm	madlo L	Kč €	9320,- 389,-	035735	10880,- 454,-	035773	12290,- 513,-	035759
	madlo R	Kč €	9320,- 389,-	035742	10880,- 454,-	035780	12290,- 513,-	035766
pro tl. dveří 52 - 60 mm	madlo L	Kč €	9480,- 395,-	035797	11030,- 460,-	035834	12440,- 519,-	035810
	madlo R	Kč €	9480,- 395,-	035803	11030,- 460,-	035841	12440,- 519,-	035827
pro tl. dveří 61 - 68 mm	madlo L	Kč €	9630,- 402,-	035858	11180,- 466,-	035896	12600,- 525,-	035872
	madlo R	Kč €	9630,- 402,-	035865	11180,- 466,-	035902	12600,- 525,-	035889
pro tl. dveří 69 - 126 mm	madlo L	Kč €	9790,- 408,-	035919	11350,- 473,-	035957	12750,- 532,-	035933
	madlo R	Kč €	9790,- 408,-	035926	11350,- 473,-	035964	12750,- 532,-	035940
madlo oboustranné	madlo L	Kč €	18320,- 764,-	035971	21430,- 893,-	036015	22830,- 952,-	035995
	madlo R	Kč €	18320,- 764,-	035988	21430,- 893,-	036022	22830,- 952,-	036008

Lze použít pro různé typy dveří s osazeným zámkem s otvory pro prošroubování rozety.



U oboustranného madla je třeba určit orientaci madla R nebo L podle vnějšího Bezpečnostního madla.

U madel pro tl. dveří 69 mm a více je třeba specifikovat přesnou tloušťku dveří. Integrovaná bezpečnostní rozeta má průměr 54 mm. Montážní materiál je nutno specifikovat podle materiálu dveří - viz. tabulka montážního materiálu str. 205. Černá nerezová madla se dodávají v novém hrubém povrchu s označením K-industrial.

			NRz		TiN-C		K-industrial	
			cena	EAN	cena	EAN	cena	EAN
pro tl. dveří 38 - 45 mm	madlo L	Kč €	9160,- 382,-	036039	10720,- 447,-	036077	13540,- 565,-	036053
	madlo R	Kč €	9160,- 382,-	036046	10720,- 447,-	036084	13540,- 565,-	036060
pro tl. dveří 46 - 52 mm	madlo L	Kč €	9320,- 389,-	036091	10880,- 454,-	036138	13700,- 571,-	036114
	madlo R	Kč €	9320,- 389,-	036107	10880,- 454,-	036145	13700,- 571,-	036121
pro tl. dveří 52 - 60 mm	madlo L	Kč €	9480,- 395,-	036152	11030,- 460,-	036190	13840,- 577,-	036176
	madlo R	Kč €	9480,- 395,-	036169	11030,- 460,-	036206	13840,- 577,-	036183
pro tl. dveří 61 - 68 mm	madlo L	Kč €	9630,- 402,-	036213	11180,- 466,-	036251	14010,- 584,-	036237
	madlo R	Kč €	9630,- 402,-	036220	11180,- 466,-	036268	14010,- 584,-	036244
pro tl. dveří 69 - 126 mm	madlo L	Kč €	9790,- 408,-	036275	11350,- 473,-	036312	14170,- 591,-	036299
	madlo R	Kč €	9790,- 408,-	036282	11350,- 473,-	036329	14170,- 591,-	036305
madlo oboustranné	madlo L	Kč €	18320,- 764,-	036336	21430,- 893,-	036374	24240,- 1010,-	036350
	madlo R	Kč €	18320,- 764,-	036343	21430,- 893,-	036381	24240,- 1010,-	036367

U oboustranného madla je třeba určit orientaci madla R nebo L podle vnějšího Bezpečnostního madla.

U madel pro tl. dveří 69 mm a více je třeba specifikovat přesnou tloušťku dveří. Integrovaná ochranná rozeta nemá šrouby pro prošroubování rozety skrz zámeč a plní základní bezpečnost. Použití ochranného madla pro hliníkové dveře. Ochranné madlo nemá certifikát NBÚ. Montážní materiál je nutno specifikovat podle materiálu dveří - viz. tabulka montážního materiálu str. 209.

Ochranné madlo Entero je možné montovat jako oboustranné (pár madel). Černá nerezová madla se dodávají v novém hrubém povrchu s označením K-industrial.



K černý mat

**Bezpečnostní madlo Entero 1000 mm**

12270,- Kč  
512,- EUR



NRz nerez - broušeno

materiál: nerezová ocel  
Kč povrch: NRz nerez - broušeno EUR

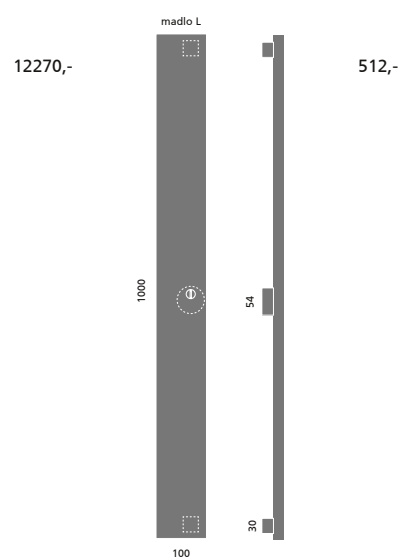

**Bezpečnostní madlo Entero 1000 mm s přidavnou rozetou**

13820,- Kč  
576,- EUR

materiál: nerezová ocel  
Kč povrch: NRz nerez - broušeno EUR

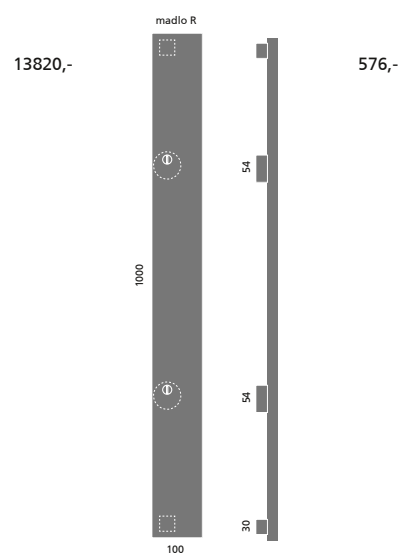

**Jednostranné kliky**



DESIGN 2006 [84 – 87]



DESIGN 2009 [88 – 95]



DESIGN 2011 [96 – 99]



DESIGN 2013 [102 – 107]



Kování pro hliníkové dveře [278 – 289]



Kování pro hliníkové dveře s orientací rozety naležato



			NRz		TiN-C		K-industrial	
			cena	EAN	cena	EAN	cena	EAN
pro tl. dveří 38 - 45 mm	madlo L	Kč €	12270,- 512,-	036398	13820,- 576,-	036435	15230,- 635,-	036411
	madlo R	Kč €	12270,- 512,-	036404	13820,- 576,-	036442	15230,- 635,-	036428
pro tl. dveří 46 - 52 mm	madlo L	Kč €	12420,- 518,-	036459	13980,- 583,-	036497	15390,- 642,-	036473
	madlo R	Kč €	12420,- 518,-	036466	13980,- 583,-	036503	15390,- 642,-	036480
pro tl. dveří 52 - 60 mm	madlo L	Kč €	12590,- 525,-	036510	14130,- 589,-	036558	15560,- 649,-	036534
	madlo R	Kč €	12590,- 525,-	036527	14130,- 589,-	036565	15560,- 649,-	036541
pro tl. dveří 61 - 68 mm	madlo L	Kč €	12740,- 531,-	036572	14280,- 595,-	036619	15690,- 654,-	036596
	madlo R	Kč €	12740,- 531,-	036589	14280,- 595,-	036626	15690,- 654,-	036602
pro tl. dveří 69 - 126 mm	madlo L	Kč €	13350,- 557,-	036633	14910,- 622,-	036671	16320,- 680,-	036657
	madlo R	Kč €	13350,- 557,-	036640	14910,- 622,-	036688	16320,- 680,-	036664
madlo oboustranné	madlo L	Kč €	24520,- 1022,-	036695	27630,- 1152,-	036732	29030,- 1210,-	036718
	madlo R	Kč €	24520,- 1022,-	036701	27630,- 1152,-	036749	29030,- 1210,-	036725

Lze použít pro různé typy dveří s osazeným zámkem **s otvory** pro prošroubování rozety.



U oboustranného madla je třeba určit orientaci madla R nebo L podle vnějšího Bezpečnostního madla.

U madel pro tl. dveří 69 mm a více je třeba specifikovat přesnou tloušťku dveří. Integrovaná bezpečnostní rozeta má průměr 54 mm. Individuálně lze dodávat i jiné rozměry madel do délky 3000 mm. Montážní materiál je nutno specifikovat podle materiálu dveří - viz. tabulka montážního materiálu. Černá nerezová madla se dodávají v novém hrubém povrchu s označením K-industrial.

			NRz		TiN-C		K-industrial	
			cena	EAN	cena	EAN	cena	EAN
pro tl. dveří 38 - 45 mm	madlo L	Kč €	13820,- 576,-	036756	15370,- 641,-	036794	16780,- 700,-	036770
	madlo R	Kč €	13820,- 576,-	036763	15370,- 641,-	036800	16780,- 700,-	036787
pro tl. dveří 46 - 52 mm	madlo L	Kč €	13980,- 583,-	036817	15510,- 647,-	036855	16920,- 705,-	036831
	madlo R	Kč €	13980,- 583,-	036824	15510,- 647,-	036862	16920,- 705,-	036848
pro tl. dveří 52 - 60 mm	madlo L	Kč €	14130,- 589,-	036879	15680,- 654,-	036916	17090,- 713,-	036893
	madlo R	Kč €	14130,- 589,-	036886	15680,- 654,-	036923	17090,- 713,-	036909
pro tl. dveří 61 - 68 mm	madlo L	Kč €	14280,- 595,-	036930	15830,- 660,-	036978	17250,- 719,-	036954
	madlo R	Kč €	14280,- 595,-	036947	15830,- 660,-	036985	17250,- 719,-	036961
pro tl. dveří 69 - 126 mm	madlo L	Kč €	14910,- 622,-	036992	16460,- 686,-	037036	17870,- 745,-	037012
	madlo R	Kč €	14910,- 622,-	037005	16460,- 686,-	037043	17870,- 745,-	037029
madlo oboustranné	madlo L	Kč €	27630,- 1152,-	037050	30720,- 1280,-	037098	32120,- 1339,-	037074
	madlo R	Kč €	27630,- 1152,-	037067	30720,- 1280,-	037104	32120,- 1339,-	037081

Lze použít pro různé typy dveří s osazeným zámkem **s otvory** pro prošroubování rozety.



U oboustranného madla je třeba určit orientaci madla R nebo L podle vnějšího Bezpečnostního madla.

Montážní materiál pro madla	cena sada	EAN	
jednostranné do slepé díry - plast	Kč €	420,- 18,-	030204
jednostranné do slepé díry - hliník	Kč €	420,- 18,-	030211
jednostranné do slepé díry - dřevo	Kč €	420,- 18,-	030228
jednostranné s prošroubováním a záslepkou	Kč €	420,- 18,-	003024
oboustranné (pro Ochranná i Bezpeč. madla)	Kč €	420,- 18,-	003048

Bezpečnostní madlo s dvojicí bezpečnostních rozet pro max. zabezpečení. Umístění / rozteč rozet je možné specifikovat. Individuálně lze dodávat i jiné rozměry madel do délky 3000 mm. U madel pro tl. dveří 69 mm a více je třeba specifikovat přesnou tloušťku dveří. Integrovaná bezpečnostní rozeta má průměr 54 mm. Černá nerezová madla se dodávají v novém hrubém povrchu s označením K-industrial.

Montážní materiál je nutno specifikovat podle materiálu dveří - viz. tabulka montážního materiálu.

K bezpečnostnímu madlu Entero se z vnitřní strany dveří dodává rozetové kování M&T - jednostranná klika. Montážně lze využít dveřní kliky DESIGN 2006, 2009, 2011, 2013 a kování pro hliníkové dveře. Objednává se 1/2 páru a je třeba specifikovat orientaci kliky L nebo R. Nezbytný montážní komponent je rozpěrný čtyřhran viz. Příslušenství a komponenty str. 368. Rozpěrný čtyřhran a jednostranná klika nejsou součástí bezpečnostního madla Entero a objednávají se zvlášť. Cena jednostranné kliky je 1/2 páru.

Součástí dodávky bezpečnostního madla Entero je vnitřní cylindrická rozeta. Vnitřní cylindrická rozeta je volitelná ve více tvarových variantách podle designu kliky.

Varianty rozety vnitřní kliky

rozeta DESIGN 2006, 2009



čtvercová 54x54 mm

rozeta DESIGN 2011



čtvercová Minimal 54x54 mm

rozeta DESIGN 2013



čtvercová Minimal 54x54 mm

obdélníková naležato (Al profily)



čtvercová Minimal 54x54 mm

obdélníková 33 mm (Al profily)



obdélníková šíře 33 mm

Varianty vnitřní cylindrické rozety



Příbuzný sortiment

Madla a koule na skleněné  
a dřevěné dveře



Madla dlouhá



## Bezpečnostní rozety

Bezpečnostní rozety M&T jsou konstrukčně navrženy a patentovány pro maximální bezpečnost, díky které plnohodnotně nahrazují štítové bezpečnostní kování. Předností je designová a barevnostní jednotnost s jakýmkoliv rozetovým kovááním z produkce M&T. Jedinečností je konstrukční variabilita s možností montáže na dveře až do tloušťky 126 mm. Těmito parametry se nemůže pochlubit žádné bezpečnostní kování na trhu.

Materiál: **masivní mosaz**

Povrchy: **SNi, Cr, SNi-broušeno, TiN-C, TiN-B, TiN-K, Ms, Ms-L, zakázkově TiN-S, TiN-A**  
více info na [www.kliky-mt.cz/manufaktura/barvy-povrchy](http://www.kliky-mt.cz/manufaktura/barvy-povrchy)

Materiál: **nerezová ocel**

Povrchy: **NRz, TiN-K, K-industrial**

Ø 54 mm **TiN-K**



**ENTERO TiN-B**



**MINIMAL SNi**



Ø 54 mm **NRz**



**ENTERO NRz**



k řadě kování DESIGN 2000

k řadě kování DESIGN 2004,  
DESIGN 2006, 2009, 2011

k řadě kování Minimal/Maximal

k řadě kování Nerezové kování,  
DESIGN 2012 ploché rozety,  
Zapuštěné rozety

možnosti kombinací



MATY



madlo ENTRY



ENTERO



madlo MINIMAL



koule MATY



madlo ENTERO



FÁBI



TORO



MIMOLIMIT



MAYA

konstrukční varianty, materiálové provedení

- rozeta z vnitřní strany dveří vždy designově shodná s rozetou kliky
- koule a madla vždy v designu podle kliky z vnitřní strany dveří
- možno i kombinovat s jakýmkoliv typem dlouhého madla
- patentovaný konstrukční systém
- vrtání s PROFI šablonou M&T pomocí univerzálního vrtáku 6,4/12 mm
- velmi rychlá a snadná montáž
- montáž pro tloušťky dveří 38 – 126 mm
- záruka 3 roky, NRz 5 let, K-industrial 5 let, titany 15 let

roky **3 garance** let **5 garance** let **15 garance**

vrtání PROFI  
šablonou M&T



Ochranné známky – registrované značky

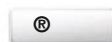

**ENTERO®**  
**MINIMAL®**

Patent



konstrukce Bezpečnostní rozety

Pro maximální bezpečnost doporučujeme kombinovat bezpečnostní rozety M&T s cylindrickými vložkami EVVA.

Certifikace: bezpečnostní certifikáty státem akreditované zkušebny Trezor Test a NBÚ (Národní bezpečnostní úřad).

Certifikáty lze stáhnout na [www.kliky-mt.cz/katalog/bezpecnostni-rozety/](http://www.kliky-mt.cz/katalog/bezpecnostni-rozety/) u jednotlivých produktů.



SNI matný nikel

**Bezpečnostní rozeta Ø 54 mm**

2330,- Kč  
98,- EUR



Ms-L mosaz leštěno



Cr lesklý chrom

Kč	materiál: zušlechťená ocel povrch: SNI matný nikel	EUR
	pro tl. dveří	
2330,-	38 - 45 mm	98,-
2500,-	46 - 52 mm	105,-
2640,-	53 - 60 mm	110,-
2800,-	61 - 68 mm	117,-
2950,-	69 - 76 mm	123,-
3110,-	77 - 83 mm	130,-
3420,-	84 - 90 mm	143,-
3730,-	91 - 97 mm	156,-
4040,-	98 - 104 mm	169,-
4350,-	105 - 112 mm	182,-
4650,-	113 - 118 mm	194,-
4980,-	119 - 126 mm	208,-



TiN-C titan chrom mat

**Bezpečnostní rozeta Ø 54 mm NRz**

2180,- Kč  
91,- EUR



TiN-K titan černý mat



NRz nerez - broušeno

Kč	materiál: nerezová ocel kalitelná povrch: NRz nerez - broušeno	EUR
	pro tl. dveří	
2180,-	38 - 45 mm	91,-
2330,-	46 - 52 mm	98,-
2500,-	53 - 60 mm	105,-
2640,-	61 - 68 mm	110,-
2800,-	69 - 76 mm	117,-
2950,-	77 - 83 mm	123,-
3260,-	84 - 90 mm	136,-
3590,-	91 - 97 mm	150,-
3880,-	98 - 104 mm	162,-
4190,-	105 - 112 mm	175,-
4510,-	113 - 118 mm	188,-
4820,-	119 - 126 mm	201,-

	SNI		NRz		Cr		Ms		Ms-L		TiN-C		TiN-K		K-industrial		
	cena ks	EAN	cena ks	EAN	cena ks	EAN	cena ks	EAN	cena ks	EAN	cena ks	EAN	cena ks	EAN	cena ks	EAN	
pro tl. dveří																	
38 - 45 mm	Kč €	2330,- 98,-	69084	2180,- 91,-	019957	2500,- 105,-	69145	2500,- 105,-	058574	2500,- 105,-	058697	3110,- 130,-	69268	3110,- 130,-	69329	3110,- 130,-	033458
46 - 52 mm	Kč €	2500,- 105,-	69091	2330,- 98,-	019964	2640,- 110,-	69152	2640,- 110,-	058581	2640,- 110,-	058703	3260,- 136,-	69275	3260,- 136,-	69336	3260,- 136,-	033465
53 - 60 mm	Kč €	2640,- 110,-	69107	2500,- 105,-	019971	2800,- 117,-	69169	2800,- 117,-	058598	2800,- 117,-	058710	3420,- 143,-	69282	3420,- 143,-	69343	3420,- 143,-	033472
61 - 68 mm	Kč €	2800,- 117,-	69114	2640,- 110,-	019988	2950,- 123,-	69176	2950,- 123,-	058604	2950,- 123,-	058727	3590,- 150,-	69299	3590,- 150,-	69350	3590,- 150,-	033489
69 - 76 mm	Kč €	2950,- 123,-	69121	2800,- 117,-	019995	3110,- 130,-	69183	3110,- 130,-	058611	3110,- 130,-	058734	3730,- 156,-	69305	3730,- 156,-	69367	3730,- 156,-	033496
77 - 83 mm	Kč €	3110,- 130,-	69138	2950,- 123,-	020007	3260,- 136,-	69190	3260,- 136,-	058628	3260,- 136,-	058741	3880,- 162,-	69312	3880,- 162,-	69374	3880,- 162,-	033502
84 - 90 mm	Kč €	3420,- 143,-	019896	3260,- 136,-	020014	3590,- 150,-	020076	3590,- 150,-	058635	3590,- 150,-	058758	4190,- 175,-	020199	4190,- 175,-	020250	4190,- 175,-	033519
91 - 97 mm	Kč €	3730,- 156,-	019902	3590,- 150,-	020021	3880,- 162,-	020083	3880,- 162,-	058642	3880,- 162,-	058765	4510,- 188,-	020205	4510,- 188,-	020267	4510,- 188,-	033526
98 - 104 mm	Kč €	4040,- 169,-	019919	3880,- 162,-	020038	4190,- 175,-	020090	4190,- 175,-	058659	4190,- 175,-	058772	4820,- 201,-	020212	4820,- 201,-	020274	4820,- 201,-	033533
105 - 112 mm	Kč €	4350,- 182,-	019926	4190,- 175,-	020045	4510,- 188,-	020106	4510,- 188,-	058666	4510,- 188,-	058789	5120,- 214,-	020229	5120,- 214,-	020281	5120,- 214,-	033540
113 - 118 mm	Kč €	4650,- 194,-	019933	4510,- 188,-	020052	4820,- 201,-	020113	4820,- 201,-	058673	4820,- 201,-	058796	5430,- 227,-	020236	5430,- 227,-	020298	5430,- 227,-	033557
119 - 126 mm	Kč €	4980,- 208,-	019940	4820,- 201,-	020069	5120,- 214,-	020120	5120,- 214,-	058680	5120,- 214,-	058802	5740,- 240,-	020243	5740,- 240,-	020304	5740,- 240,-	033564

U kombinace klika / klika a koule / klika k Bezpečnostní rozetě Ø 54 mm jsou standardně použity kovové podrozety odolné proti rozlomení. Objednávkové EAN klika / klika a koule / klika viz. Design 2000 str. 74 - 79, EAN pro Nerezové kliky str. 30 - 33.

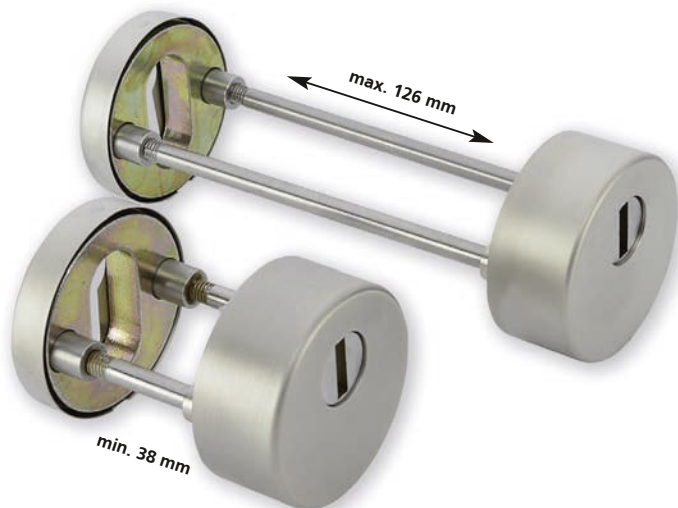

Doporučený výstup cylindrické vložky z vnitřní strany dveří 11 - 12 mm.

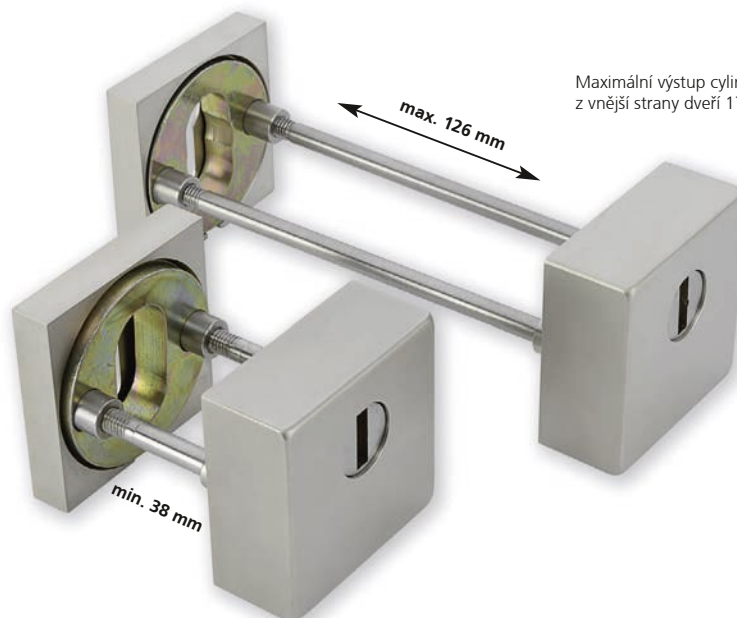

Maximální výstup cylindrické vložky z vnější strany dveří 17,5 mm.



SNi matný nikl



TiN-K titan černý mat



TiN-S titan bronz mat



Cr lesklý chrom



TiN-B titan braun mat



SNi - broušeno matný nikl broušený



TiN-C titan chrom mat



TiN-A titan mosaz mat



NRz nerez - broušeno

### Bezpečnostní rozeta Entero

3880,- Kč  
162,- EUR

Kč	materiál: zušlechťená ocel povrch: SNi matný nikl	EUR
	pro tl. dveří	
3880,-	38 - 45 mm	162,-
4040,-	46 - 52 mm	169,-
4190,-	53 - 60 mm	175,-
4510,-	61 - 68 mm	188,-
4650,-	69 - 76 mm	194,-
4820,-	77 - 83 mm	201,-
5120,-	84 - 90 mm	214,-
5430,-	91 - 97 mm	227,-
5740,-	98 - 104 mm	240,-
6060,-	105 - 112 mm	253,-
6360,-	113 - 118 mm	265,-
6680,-	119 - 126 mm	279,-

### Bezpečnostní rozeta Entero NRz

3590,- Kč  
150,- EUR

Kč	materiál: nerezová ocel kalitelná povrch: NRz nerez - broušeno	EUR
	pro tl. dveří	
3590,-	38 - 45 mm	150,-
3730,-	46 - 52 mm	156,-
3880,-	53 - 60 mm	162,-
4040,-	61 - 68 mm	169,-
4190,-	69 - 76 mm	175,-
4510,-	77 - 83 mm	188,-
4820,-	84 - 90 mm	201,-
5120,-	91 - 97 mm	214,-
5430,-	98 - 104 mm	227,-
5740,-	105 - 112 mm	240,-
6060,-	113 - 118 mm	253,-
6360,-	119 - 126 mm	265,-

	SNI		SNI - broušeno		NRz		Cr		K-industrial		
	cena / ks	EAN	cena / ks	EAN	cena / ks	EAN	cena / ks	EAN	cena / ks	EAN	
pro tl. dveří											
38 - 45 mm	Kč €	3880,- 162,-	021813	3880,- 162,-	68780	3590,- 150,-	020434	4040,- 169,-	68841	4650,- 194,-	033571
46 - 52 mm	Kč €	4040,- 169,-	021820	4040,- 169,-	68797	3730,- 156,-	020441	4190,- 175,-	68858	4820,- 201,-	033588
53 - 60 mm	Kč €	4190,- 175,-	021837	4190,- 175,-	68803	3880,- 162,-	020458	4350,- 182,-	68865	4980,- 208,-	033595
61 - 68 mm	Kč €	4510,- 188,-	021844	4510,- 188,-	68810	4040,- 169,-	020465	4650,- 194,-	68872	5280,- 220,-	033601
69 - 76 mm	Kč €	4650,- 194,-	021851	4650,- 194,-	68827	4190,- 175,-	020472	4820,- 201,-	68889	5430,- 227,-	033618
77 - 83 mm	Kč €	4820,- 201,-	021868	4820,- 201,-	68834	4510,- 188,-	020489	4980,- 208,-	68896	5590,- 233,-	033625
84 - 90 mm	Kč €	5120,- 214,-	021875	5120,- 214,-	020373	4820,- 201,-	020496	5280,- 220,-	020557	5910,- 247,-	033632
91 - 97 mm	Kč €	5430,- 227,-	021882	5430,- 227,-	020380	5120,- 214,-	020502	5590,- 233,-	020564	6210,- 259,-	033649
98 - 104 mm	Kč €	5740,- 240,-	021899	5740,- 240,-	020397	5430,- 227,-	020519	5910,- 247,-	020571	6510,- 272,-	033656
105 - 112 mm	Kč €	6060,- 253,-	021905	6060,- 253,-	020403	5740,- 240,-	020526	6210,- 259,-	020588	6820,- 285,-	033663
113 - 118 mm	Kč €	6360,- 265,-	021912	6360,- 265,-	020410	6060,- 253,-	020533	6510,- 272,-	020595	7150,- 298,-	033670
119 - 126 mm	Kč €	6680,- 279,-	021929	6680,- 279,-	020427	6360,- 265,-	020540	6820,- 285,-	020601	7460,- 311,-	033687

	TiN-S		TiN-C		TiN-B		TiN-K		TiN-A		
	cena / ks	EAN	cena / ks	EAN	cena / ks	EAN	cena / ks	EAN	cena / ks	EAN	
pro tl. dveří											
38 - 45 mm	Kč €	4650,- 194,-	68902	4650,- 194,-	68964	4650,- 194,-	65505	4650,- 194,-	69022	4650,- 194,-	73555
46 - 52 mm	Kč €	4820,- 201,-	68919	4820,- 201,-	68971	4820,- 201,-	65512	4820,- 201,-	69039	4820,- 201,-	73562
53 - 60 mm	Kč €	4980,- 208,-	68926	4980,- 208,-	68988	4980,- 208,-	65529	4980,- 208,-	69046	4980,- 208,-	73579
61 - 68 mm	Kč €	5280,- 220,-	68933	5280,- 220,-	68995	5280,- 220,-	65536	5280,- 220,-	69053	5280,- 220,-	73586
69 - 76 mm	Kč €	5430,- 227,-	68940	5430,- 227,-	69008	5430,- 227,-	65543	5430,- 227,-	69060	5430,- 227,-	73593
77 - 83 mm	Kč €	5590,- 233,-	68957	5590,- 233,-	69015	5590,- 233,-	65550	5590,- 233,-	69077	5590,- 233,-	73609
84 - 90 mm	Kč €	5910,- 247,-	020618	5910,- 247,-	020731	5910,- 247,-	020793	5910,- 247,-	020854	5910,- 247,-	020915
91 - 97 mm	Kč €	6210,- 259,-	020625	6210,- 259,-	020748	6210,- 259,-	020809	6210,- 259,-	020861	6210,- 259,-	020922
98 - 104 mm	Kč €	6510,- 272,-	020632	6510,- 272,-	020755	6510,- 272,-	020816	6510,- 272,-	020878	6510,- 272,-	020939
105 - 112 mm	Kč €	6820,- 285,-	020649	6820,- 285,-	020762	6820,- 285,-	020823	6820,- 285,-	020885	6820,- 285,-	020946
113 - 118 mm	Kč €	7150,- 298,-	020656	7150,- 298,-	020779	7150,- 298,-	020830	7150,- 298,-	020892	7150,- 298,-	020953
119 - 126 mm	Kč €	7460,- 311,-	020663	7460,- 311,-	020786	7460,- 311,-	020847	7460,- 311,-	020908	7460,- 311,-	020960

U kombinace klika / klika a madlo / klika k Bezpečnostní rozetě Entero jsou standardně použity kovové podrozety odolné proti rozlomení u klik Design 2004 a Nerezových klik. Objednávkové EAN klika / klika a madlo / klika viz. Design 2004 str. 80 - 83, Design 2006 str. 86 - 87, Design 2009 str. 90 - 93, Design 2011 str. 98 - 99. EAN pro Nerezové kliky str. 34 - 35.



SNi matný nikel



TiN-K titan černý mat



TiN-B titan braun mat

**Bezpečnostní rozeta Minimal**

4650,- Kč  
194,- EUR

Kč	materiál: zušlechťená ocel povrch: SNI matný nikel	EUR
	pro tl. dveří	
4650,-	38 - 45 mm	194,-
4820,-	46 - 52 mm	201,-
4980,-	53 - 60 mm	208,-
5280,-	61 - 68 mm	220,-
5430,-	69 - 76 mm	227,-
5590,-	77 - 83 mm	233,-
5910,-	84 - 90 mm	247,-
6210,-	91 - 97 mm	259,-
6510,-	98 - 104 mm	272,-
6820,-	105 - 112 mm	285,-
7150,-	113 - 118 mm	298,-
7460,-	119 - 126 mm	311,-

	SNI		SNI - broušeno		Cr		TiN-C		TiN-B		TiN-K		TiN-A		K-industrial		
	cena	EAN	cena	EAN	cena	EAN	cena	EAN	cena	EAN	cena	EAN	cena	EAN	cena	EAN	
	ks		ks		ks		ks		ks		ks		ks		ks		
pro tl. dveří																	
38 - 45 mm	Kč €	4650,- 194,-	020977	4650,- 194,-	021097	4820,- 201,-	021219	5430,- 227,-	021332	5430,- 227,-	021455	5430,- 227,-	021578	5430,- 227,-	021691	5430,- 227,-	142655
46 - 52 mm	Kč €	4820,- 201,-	020984	4820,- 201,-	021103	4980,- 208,-	021226	5590,- 233,-	021349	5590,- 233,-	021462	5590,- 233,-	021585	5590,- 233,-	021707	5590,- 233,-	142662
53 - 60 mm	Kč €	4980,- 208,-	020991	4980,- 208,-	021110	5120,- 214,-	021233	5740,- 240,-	021356	5740,- 240,-	021479	5740,- 240,-	021592	5740,- 240,-	021714	5740,- 240,-	142679
61 - 68 mm	Kč €	5280,- 220,-	021004	5280,- 220,-	021127	5430,- 227,-	021240	6060,- 253,-	021363	6060,- 253,-	021486	6060,- 253,-	021608	6060,- 253,-	021721	6060,- 253,-	142686
69 - 76 mm	Kč €	5430,- 227,-	021011	5430,- 227,-	021134	5590,- 233,-	021257	6210,- 259,-	021370	6210,- 259,-	021493	6210,- 259,-	021615	6210,- 259,-	021738	6210,- 259,-	142693
77 - 83 mm	Kč €	5590,- 233,-	021028	5590,- 233,-	021141	5740,- 240,-	021264	6360,- 265,-	021387	6360,- 265,-	021509	6360,- 265,-	021622	6360,- 265,-	021745	6360,- 265,-	142709
84 - 90 mm	Kč €	5910,- 247,-	021035	5910,- 247,-	021158	6060,- 253,-	021271	6680,- 279,-	021394	6680,- 279,-	021516	6680,- 279,-	021639	6680,- 279,-	021752	6680,- 279,-	142716
91 - 97 mm	Kč €	6210,- 259,-	021042	6210,- 259,-	021165	6360,- 265,-	021288	6980,- 291,-	021400	6980,- 291,-	021523	6980,- 291,-	021646	6980,- 291,-	021769	6980,- 291,-	142723
98 - 104 mm	Kč €	6510,- 272,-	021059	6510,- 272,-	021172	6680,- 279,-	021295	7290,- 304,-	021417	7290,- 304,-	021530	7290,- 304,-	021653	7290,- 304,-	021776	7290,- 304,-	142730
105 - 112 mm	Kč €	6820,- 285,-	021066	6820,- 285,-	021189	6980,- 291,-	021301	7610,- 318,-	021424	7610,- 318,-	021547	7610,- 318,-	021660	7610,- 318,-	021783	7610,- 318,-	142747
113 - 118 mm	Kč €	7150,- 298,-	021073	7150,- 298,-	021196	7290,- 304,-	021318	7910,- 330,-	021431	7910,- 330,-	021554	7910,- 330,-	021677	7910,- 330,-	021790	7910,- 330,-	142754
119 - 126 mm	Kč €	7460,- 311,-	021080	7460,- 311,-	021202	7610,- 318,-	021325	8230,- 343,-	021448	8230,- 343,-	021561	8230,- 343,-	021684	8230,- 343,-	021806	8230,- 343,-	142761

U kombinace kliky / kliky a madlo / kliky k Bezpečnostní rozetě Minimal se standardně dodává kliky Minimal. Objednávkové EAN kliky / kliky a madlo / kliky viz. Design 2013 str. 102 - 103.







Příbuzný sortiment

Bezpečnostní rozety



Kování pro hliníkové a ocelové dveře,  
kování na branky



Příslušenství a komponenty  
Rozpěrný čtyřhran

**Jednostranné kliky**

DESIGN 2006  
DESIGN 2009  
DESIGN 2011  
DESIGN 2013

## Madla dlouhá

Dlouhá madla M&T jsou vyráběna v několika materiálových a designových řadách splňujících náročné požadavky zákazníků na tvar, použití a rozměry. Řada nerezových madel je univerzální pro široký okruh použití ve variantě rovné nebo vyosené s možností zakázkové výroby v individuálních délkách. Madla Minimal / Maximal vynikají svým designem a velkou předností je možnost kombinací ve všech barevných odstínech povrchových úprav M&T. Jedinečností je konstrukční variabilita u madel Mimolimit s použitím různých masivních dřevin, kde je standardně možnost dodání madel až do délky 2440 mm. Mimořádná v nabídce jsou madla Yes! s unikátním integrovaným WC zamykáním.

Materiál: **masivní mosaz**   
Povrchy: **SNi, Cr, SNi-broušeno, TiN-C, TiN-B, TiN-K, Ms, Ms-L, zakázkově TiN-A**  
více info na [www.kliky-mt.cz/manufaktura/barvy-povrchy](http://www.kliky-mt.cz/manufaktura/barvy-povrchy)

Materiál: **nerezová ocel**  
Povrchy: **NRz, K-industrial, TiN-C, TiN-A**

madla  
Minimal/Maximal  
**TiN-K** titan černý mat

madla Mimolimit  
**SNi** matný nikl  
+ masivní dřevo teak

madla Yes!  
**TiN-K** titan černý mat

madla řady Entero, Lusy, Deny,  
Andy, Tyčinka  
**NRz** nerez - broušeno



str. 240 - 249

### konstrukční varianty, materiálové provedení

- madla jsou vyráběna jako jednostranná, nebo oboustranná
- montážně pro skleněné, nebo dřevěné dveře (včetně plastových, ocelových, hliníkových)
- montážní materiál není součástí madel, je třeba specifikovat podle typu dveří a varianty použití
- madla Mimolimit dodáváme v délkách od 340 mm do 2440 mm
- nerezová madla s možností individuální délky
- černá nerezová madla se dodávají v novém hrubém povrchu s označením K-industrial, do délky max. 2500 mm
- vyosená nerezová madla jsou vyrobena s vyosením pod úhlem 45°
- nerezová madla lze individuálně podle charakteru zakázky povlakovat titanovými povrchy do délky max. 1000 mm
- k jednostranným madlům lze objednat jednostranné kliky (1/2 páru) s rozpěrným čtyřhranem - viz. Příslušenství a komponenty
- výkresy vrtání otvorů pro montáž madel na [www.kliky-mt.cz/montaze-kovani](http://www.kliky-mt.cz/montaze-kovani)
- záruka 3 roky, NRz 5 let, K-industrial 5 let, titany 15 let

### Ochranné známky – registrované značky



**ENTERO®**  
**MINIMAL®**  
**MAXIMAL®**  
**MIMOLIMIT®**

### Chráněné průmyslové vzory madel



**MIMOLIMIT**  
**MINIMAL**  
**MAXIMAL**  
**YES!**

roky **3 garance** let **5 garance** let **15 garance**



TiN-K titan černý mat

TiN-B titan braun mat

**Madlo dlouhé Minimal**  
rozteč 250 / délka 297 mm

12260,- Kč  
511,- EUR

**Madlo dlouhé Maximal**  
rozteč 250 / délka 297 mm

12680,- Kč  
529,- EUR

SNi matný nikl  
výplň dřevo teak

**Výplň madla  
Maximal**

630,- Kč  
27,- EUR

**Madlo Mimolimit**

4570,- Kč  
191,- EUR

TiN-B titan braun mat  
+ bělený dub

SNi matný nikl + teak

TiN-K titan černý mat + jilm

materiál: masivní mosaz  
povrch: SNi matný nikl

**KČ** **EUR**

12260,- 511,-

6150,- 257,-

12680,- 529,-

6360,- 265,-

materiál: masivní mosaz  
povrch: SNi matný nikl  
broušeno

**KČ** **EUR**

4570,- 191,-

5460,- 228,-

8020,- 335,-

9070,- 378,-

11940,- 498,-

14990,- 625,-

materiál: masivní dřevo  
povrch: olejováno

**KČ** **EUR**

1260,- 53,-

1850,- 78,-

2470,- 103,-

2740,- 115,-

3290,- 138,-

3700,- 155,-

**Dřevěná část madla**

1260,- Kč  
53,- EUR



		Sni		Sni - broušeno		Cr		Ms		TiN-C		TiN-B		TiN-K	
		cena	EAN	cena	EAN	cena	EAN	cena	EAN	cena	EAN	cena	EAN	cena	EAN
oboustranné	Kč €	pár 12260,- 511,-	002706	pár 12610,- 526,-	002713	pár 13000,- 542,-	002720	pár 13000,- 542,-	058819	pár 15350,- 640,-	002737	pár 15350,- 640,-	002744	pár 15350,- 640,-	002751
jednostranné	Kč €	ks 6150,- 257,-	002775	ks 6310,- 263,-	002782	ks 6510,- 272,-	002799	ks 6510,- 272,-	058826	ks 7690,- 321,-	002805	ks 7690,- 321,-	002812	ks 7690,- 321,-	002829
oboustranné	Kč €	pár 12680,- 529,-	002843	pár 13040,- 544,-	002850	pár 13390,- 558,-	002867	pár 13390,- 558,-	058857	pár 15830,- 660,-	002874	pár 15830,- 660,-	002881	pár 15830,- 660,-	002898
jednostranné	Kč €	ks 6360,- 265,-	002911	ks 6530,- 273,-	002928	ks 6710,- 280,-	002935	ks 6710,- 280,-	058864	ks 7930,- 331,-	002942	ks 7930,- 331,-	002959	ks 7930,- 331,-	002966

		cena	EAN
		ks	
dřevo	Kč €	630,- 27,-	002980
kov	Kč €	630,- 27,-	002997
kůže	Kč €	750,- 32,-	003000
„sklo“	Kč €	750,- 32,-	003017
RAL barvy	Kč €	780,- 33,-	022520

Montážní materiál pro madla	cena	EAN
	sada	
jednostranné do slepé díry - plast	Kč €	420,- 18,-
jednostranné do slepé díry - hliník	Kč €	420,- 18,-
jednostranné do slepé díry - dřevo	Kč €	420,- 18,-

Montážní materiál pro madla	cena	EAN
	sada	
jednostranné s prošroubováním a záslepkou	Kč €	420,- 18,-
jednostranné na sklo s prošroubováním a záslepkou	Kč €	550,- 23,-
oboustranné	Kč €	420,- 18,-
oboustranné na sklo	Kč €	550,- 23,-



rozteč / celk. délka		Sni - broušeno		Cr		Ms		TiN-C		TiN-K		TiN-B	
		cena	EAN	cena	EAN	cena	EAN	cena	EAN	cena	EAN	cena	EAN
		ks		ks		ks		ks		ks		ks	
300 / 340 mm	Kč €	4570,- 191,-	83301	4710,- 197,-	022209	4710,- 197,-	058895	6690,- 279,-	83349	6690,- 279,-	83363	6690,- 279,-	83387
600 / 640 mm	Kč €	5460,- 228,-	83318	5610,- 234,-	022216	5610,- 234,-	058901	7590,- 317,-	83356	7590,- 317,-	83370	7590,- 317,-	83394
900 / 940 mm	Kč €	8020,- 335,-	83974	8170,- 341,-	022223	8170,- 341,-	058918	10470,- 437,-	84018	10470,- 437,-	84056	10470,- 437,-	84094
1200 / 1240 mm	Kč €	9070,- 378,-	83981	9240,- 385,-	022230	9240,- 385,-	058925	11200,- 467,-	84025	11200,- 467,-	84063	11200,- 467,-	84100
1800 / 1840 mm	Kč €	11940,- 498,-	83998	12120,- 505,-	022247	12120,- 505,-	058932	14910,- 622,-	84032	14910,- 622,-	84070	14910,- 622,-	84117
2400 / 2440 mm	Kč €	14990,- 625,-	84001	15140,- 631,-	022254	15140,- 631,-	058949	18600,- 775,-	84049	18600,- 775,-	84087	18600,- 775,-	84124

pro rozteč		Teak		Jilm		Ořech		Dub		Bělený dub	
		cena	EAN	cena	EAN	cena	EAN	cena	EAN	cena	EAN
		ks		ks		ks		ks		ks	
300 mm	Kč €	1260,- 53,-	83400	1030,- 43,-	83424	1030,- 43,-	83448	1030,- 43,-	83936	1150,- 48,-	83950
600 mm	Kč €	1850,- 78,-	83417	1540,- 65,-	83431	1540,- 65,-	83929	1540,- 65,-	83943	1700,- 71,-	83967
900 mm	Kč €	2470,- 103,-	84131	2050,- 86,-	84179	2050,- 86,-	84216	2050,- 86,-	84254	2270,- 95,-	84292
1200 mm	Kč €	2740,- 115,-	84148	2410,- 101,-	84186	2410,- 101,-	84223	2410,- 101,-	84261	2650,- 111,-	84308
1800 mm	Kč €	3290,- 138,-	84155	2740,- 115,-	84193	2740,- 115,-	84230	2740,- 115,-	84278	3020,- 126,-	84315
2400 mm	Kč €	3700,- 155,-	84162	3090,- 129,-	84209	3090,- 129,-	84247	3090,- 129,-	84285	3400,- 142,-	84322

Zakázkově lze rukojeť dodat v dalších dřevinách.

Ceny madel jsou uvedeny bez montážního materiálu. Montážní materiál je nutno specifikovat podle materiálu dveří. Tabulka montážního materiálu na str. 225.

**Kč** materiál: nerezová ocel  
povrch: NRz nerez - broušeno **EUR**

**Madlo Lusy Ø 30 mm**

3180,- Kč  
133,- EUR

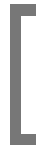
3180,-		133,-
3260,-		136,-
3730,-		156,-

**Madlo Deny Ø 30 mm**

2200,- Kč  
92,- EUR

2200,-		92,-
2320,-		97,-
2800,-		117,-

**Madlo Andy Ø 30 mm**

4110,- Kč  
172,- EUR

4110,-		172,-
4480,-		187,-

**Madlo Entero II □ 20/30 mm**

4620,- Kč  
193,- EUR

4620,-		193,-
5100,-		213,-
5630,-		235,-

**Madlo Entero □ 20/30 mm**  
úchopná část

4440,- Kč  
185,- EUR

4440,-		185,-
4610,-		193,-
5090,-		213,-

**Madlo Tyčinka Ø 20 mm**

3050,- Kč  
128,- EUR

3050,-		128,-
3420,-		143,-
3740,-		156,-
4160,-		174,-

NRz nerez - broušeno

K-industrial černý mat strukturovaný

		NRz		TiN-C		K-industrial		TiN-A	
		cena / ks	EAN	cena / ks	EAN	cena / ks	EAN	cena / ks	EAN
rozteč 230 mm	Kč €	3180,- 133,-	30602	4850,- 203,-	30695	6270,- 262,-	30725	4850,- 203,-	42759
rozteč 350 mm	Kč €	3260,- 136,-	30619	4940,- 206,-	30701	6360,- 265,-	30732	4940,- 206,-	42766
rozteč 650 mm	Kč €	3730,- 156,-	30626	5410,- 226,-	30718	6820,- 285,-	30749	5410,- 226,-	42773
rozteč 230 mm	Kč €	2200,- 92,-	30008	3860,- 161,-	30091	5280,- 220,-	30121	3860,- 161,-	42780
rozteč 350 mm	Kč €	2320,- 97,-	30015	4000,- 167,-	30107	5410,- 226,-	30138	4000,- 167,-	42797
rozteč 650 mm	Kč €	2800,- 117,-	30022	4500,- 188,-	30114	5910,- 247,-	30145	4500,- 188,-	42803
rozteč 350 mm / celková délka 500 mm	Kč €	4110,- 172,-	31005	5790,- 242,-	31036	7190,- 300,-	31043	5790,- 242,-	42827
rozteč 550 mm / celková délka 700 mm	Kč €	4480,- 187,-	72565	6170,- 258,-	72596	7580,- 316,-	72602	6170,- 258,-	72619
rozteč 230 mm / celková délka 380 mm	Kč €	4620,- 193,-	73371	6590,- 275,-	73463	7990,- 333,-	73494	6590,- 275,-	73524
rozteč 350 mm / celková délka 500 mm	Kč €	5100,- 213,-	73388	7090,- 296,-	73470	8500,- 355,-	73500	7090,- 296,-	73531
rozteč 650 mm / celková délka 800 mm	Kč €	5630,- 235,-	73395	7610,- 318,-	73487	9030,- 377,-	73517	7610,- 318,-	73548
rozteč 230 mm	Kč €	4440,- 185,-	73197	6420,- 268,-	73289	7840,- 327,-	73319	6420,- 268,-	73340
rozteč 350 mm	Kč €	4610,- 193,-	73203	6580,- 275,-	73296	7980,- 333,-	73326	6580,- 275,-	73357
rozteč 650 mm	Kč €	5090,- 213,-	73210	7060,- 295,-	73302	8470,- 353,-	73333	7060,- 295,-	73364
rozteč 300 mm / celková délka 400 mm	Kč €	3050,- 128,-	157277	4730,- 198,-	157314	6130,- 256,-	157352	4730,- 198,-	157390
rozteč 600 mm / celková délka 700 mm	Kč €	3420,- 143,-	157284	5110,- 213,-	157321	6520,- 272,-	157369	5110,- 213,-	157406
rozteč 900 mm / celková délka 1000 mm	Kč €	3740,- 156,-	157291	5430,- 227,-	157338	6840,- 285,-	157376	5430,- 227,-	157413
rozteč 1500 mm / celková délka 1600 mm	Kč €	4160,- 174,-	157307	5860,- 245,-	157345	7270,- 303,-	157383	5860,- 245,-	157420

Černá nerezová madla se dodávají v novém hrubém povrchu s označením K-industrial.

Titanové povrchy na madlech lze povlakovat individuálně podle rozsahu a charakteru zakázky.

Ceny modelů jsou uvedeny bez montážního materiálu. Montážní materiál je nutno specifikovat podle materiálu dveří. Tabulka montážního materiálu na str. 225.



NRz nerez - broušeno

**Madlo Lusy Ø 30 mm  
vyosené**

4300,- Kč  
180,- EUR

**Madlo Andy Ø 30 mm  
vyosené**

4500,- Kč  
188,- EUR

**Madlo Andy II Ø 32 mm  
vyosené**

4990,- Kč  
208,- EUR



K-industrial černý mat strukturovaný

**Madlo Entero II □ 20/30 mm  
vyosené**

6770,- Kč  
283,- EUR

**Madlo Entero □ 30/30 mm  
vyosené**

6810,- Kč  
284,- EUR



materiál: nerezová ocel  
povrch: NRz nerez - broušeno

**KČ** **EUR**

4300,- 180,-

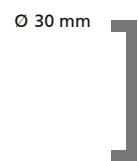

4500,- 188,-

4870,- 203,-

4500,- 188,-

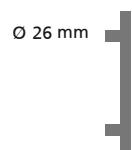

4640,- 194,-

5070,- 212,-

4990,- 208,-

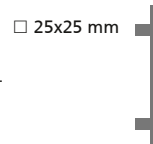

5140,- 215,-

5330,- 223,-

6770,- 283,-

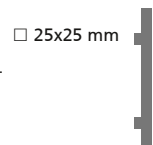

6930,- 289,-

7130,- 298,-

6810,- 284,-

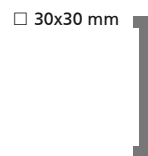

6990,- 292,-

7190,- 300,-



		NRz		TiN-C		K-industrial		TiN-A	
		cena / ks	EAN	cena / ks	EAN	cena / ks	EAN	cena / ks	EAN
rozteč 350 mm	Kč €	4300,- 180,-	030235	5990,- 250,-	030266	7400,- 309,-	030297	5990,- 250,-	030327
rozteč 550 mm	Kč €	4500,- 188,-	030242	6200,- 259,-	030273	7610,- 318,-	030303	6200,- 259,-	030334
rozteč 850 mm	Kč €	4870,- 203,-	030259	7360,- 307,-	030280	8760,- 365,-	030310	7360,- 307,-	030341
rozteč 350 mm celková délka 500 mm	Kč €	4500,- 188,-	030358	6200,- 259,-	030389	7610,- 318,-	030419	6200,- 259,-	030440
rozteč 550 mm celková délka 700 mm	Kč €	4640,- 194,-	030365	6350,- 265,-	030396	7750,- 323,-	030426	6350,- 265,-	030457
rozteč 850 mm celková délka 1000 mm	Kč €	5070,- 212,-	030372	7560,- 315,-	030402	8960,- 374,-	030433	7560,- 315,-	030464
rozteč 350 mm celková délka 500 mm	Kč €	4990,- 208,-	030471			8070,- 337,-	033755		
rozteč 550 mm celková délka 700 mm	Kč €	5140,- 215,-	030488			8230,- 343,-	033762		
rozteč 850 mm celková délka 1000 mm	Kč €	5330,- 223,-	030495			8410,- 351,-	033779		
rozteč 350 mm celková délka 500 mm	Kč €	6770,- 283,-	030501	8470,- 353,-	030532	9880,- 412,-	030563	8470,- 353,-	030594
rozteč 550 mm celková délka 700 mm	Kč €	6930,- 289,-	030518	8630,- 360,-	030549	10040,- 419,-	030570	8630,- 360,-	030600
rozteč 850 mm celková délka 1000 mm	Kč €	7130,- 298,-	030525	9600,- 400,-	030556	11020,- 460,-	030587	9600,- 400,-	030617
rozteč 350 mm	Kč €	6810,- 284,-	030624	8530,- 356,-	030655	9940,- 415,-	030686	8530,- 356,-	030716
rozteč 550 mm	Kč €	6990,- 292,-	030631	8700,- 363,-	030662	10120,- 422,-	030693	8700,- 363,-	030723
rozteč 850 mm	Kč €	7190,- 300,-	030648	9680,- 404,-	030679	11080,- 462,-	030709	9680,- 404,-	030730

Černá nerezová madla se dodávají v novém hrubém povrchu s označením K-industrial.

Titanové povrchy na madlech lze povlakovat individuálně podle rozsahu a charakteru zakázky.

Montážní materiál pro madla	cena sada	EAN
jednostranné s prošroubováním a záslepkou	Kč € 420,- 18,-	003024
jednostranné na sklo s prošroubováním a záslepkou	Kč € 550,- 23,-	003031
oboustranné	Kč € 420,- 18,-	003048
oboustranné na sklo	Kč € 550,- 23,-	003055

Montážní materiál pro madla	cena sada	EAN
jednostranné do slepé díry - plast	Kč € 420,- 18,-	030204
jednostranné do slepé díry - hliník	Kč € 420,- 18,-	030211
jednostranné do slepé díry - dřevo	Kč € 420,- 18,-	030228

Ceny madel jsou uvedeny bez montážního materiálu. Montážní materiál je nutno specifikovat podle materiálu dveří.

**M&T**  
m a g n e t i c





reddot winner 2020

double

Pro svůj výjimečný design obdržela madla Konzerva 220 a YES! spolu se systémem Magnetic prestižní mezinárodní ceny za design 2x RED DOT Design Award 2020.





reddot winner 2020



Příbuzný sortiment

[www.magnetic-mt.cz](http://www.magnetic-mt.cz)

Ovládací madla



Neviditelné zárubně



Zapuštěné soklové lišty



## System Magnetic

Revoluční systém ovládání otočných dveří bez použití kliky a zámku. Do Magneticu jsme zapracovali řadu velmi silných magnetů a umístili je do dveřní zárubně, naproti do dveřního křídla jsme zasadili blok z magnetické nerez oceli. Při dovírání dveří se k sobě obě části přiblíží a působením magnetické síly zajistí plynulé dokonalé dovření. Magnetic disponuje jednoduchým seřízením výkonu magnetů při dovření dveří - dokonalý komfort na interiérových dveřích. I díky těmto přednostem obdržel Magnetic v roce 2020 mezinárodní cenu za design RED DOT Design Award.

Materiál: **kovová konstrukce + neodymové magnety**  
Povrchy: **černá matná, bílá matná RAL 9003, broušená nerez efekt, satén nikel efekt**

Materiál: **kovová konstrukce + magnetická nerez ocel**  
Povrchy: **černá matná, bílá matná RAL 9003, broušená nerez ocel**

### MAGNETIC



### MAGNETICKÝ BLOK

#### SEŘÍDITELNÝ



#### STANDARD



#### hlavní výhody

- systém bez zámku a bez kliky
- bez možnosti mechanického opotřebení součástek
- mnohonásobně delší životnost oproti klíče a zámku
- regulace síly ovládání dveří
- tiché ovládání dveří
- bezservisní a bezúdržbový systém
- inovativní design ovládacích modelů

Patent

systém MAGNETIC

patent

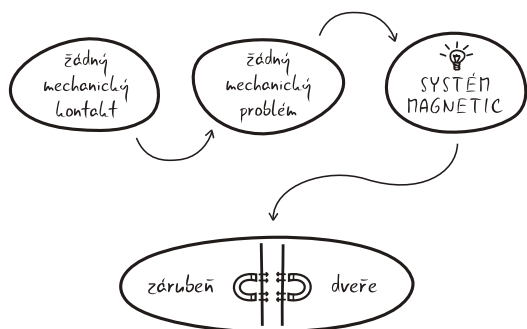

bez zámku + bez kliky = bez problému tedy bez servisu

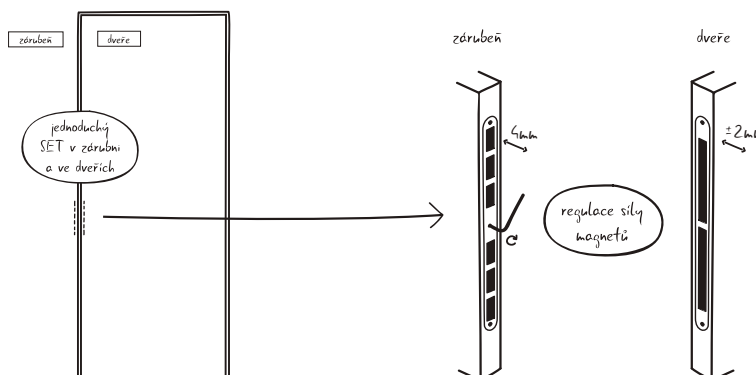



**Držák / deska do obložkové zárubně**  
+ podložky 0,1 mm, 0,3 mm, 0,5 mm, 1 mm

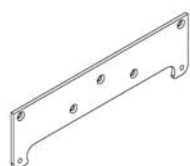

ocel, pozink  
EAN 112832 cena 140,- Kč / 5,9 EUR

### Montáž Magneticu

do obložkové zárubně šrouby TORX M5 × 20 mm

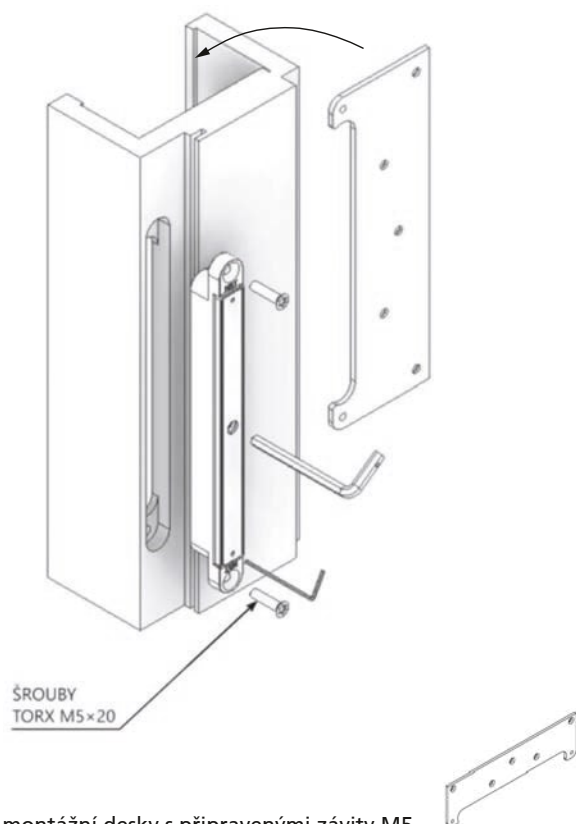

pomocí montážní desky s připravenými závitmi M5  
Montážní deska je přichycena vruty z vnitřní strany zárubně.

materiál: kovové tělo + neodymové magnety  
Kč povrch: černá matná EUR

### Magnetic

1860,-

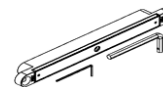

78,-

1860,- Kč  
78,- EUR

materiál: kovové tělo + magnetická nerez ocel  
Kč povrch: černá matná EUR

### Magnetický blok

580,-



25,-

580,- Kč  
25,- EUR

210,-



8,8

### Montážní magnet pr. 42 mm do obložkové zárubně



EAN 120837 cena 160,- Kč / 6,7 EUR

### Montáž zárubně

Zásadní důraz je potřeba klást na správné usazení obložkové zárubně. Magnetic má velkou sílu a při nesprávné montáži může odtrhnout zárubeň od zdi. Obložkovou zárubeň je třeba pěnit dvousložkovou pěnou (např. TKK Tekapur 2K foam, u M&T k dispozici).

Další variantou je usazení fixního magnetu průměr 42 mm na zeď pomocí hmoždinky Fischer Intelligent DUOPOWER (u M&T k dispozici). Magnet poté k sobě přitáhne obložkovou zárubeň (která je z vnitřní strany osazena montážní ocelovou deskou) a tím ji zamezí jakémukoliv pozdějšímu uvolnění.

### Montáž magnetu 42 mm na zdivo pomocí hmoždinky Fisher Intelligent DUOPOWER

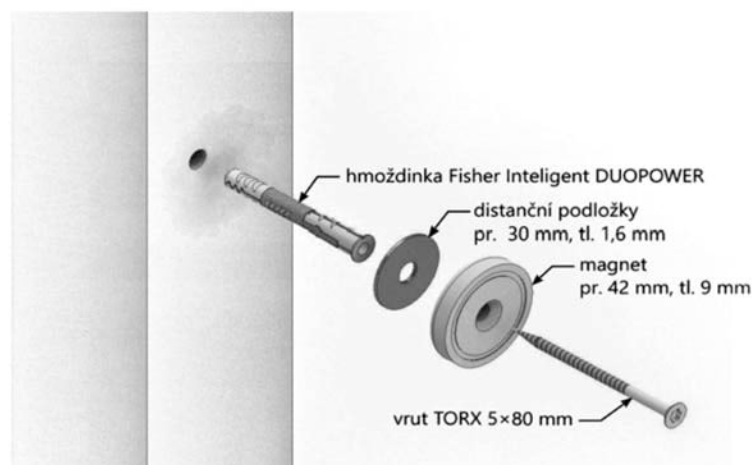

Při využití distančních podložek se použije vrut 90 mm.

	Černá matná		Satén nikel efekt		Bílá RAL 9003		Broušená nerez efekt	
	cena / ks	EAN	cena / ks	EAN	cena / ks	EAN	cena / ks	EAN
Kč €	1860,- 78,-	108613	1650,- 69,-	108651	1860,- 79,-	110609	1650,- 69,-	120806

	Černá matná		Broušená nerez		Bílá RAL 9003		
	cena / ks	EAN	cena / ks	EAN	cena / ks	EAN	
seřiditelný 0 / -2 / +2 mm	Kč €	580,- 25,-	108620	470,- 20,-	108668	580,- 25,-	110616
standard bez seřízení	Kč €	210,- 8,8	112603	130,- 5,5	112597	210,- 8,8	112610

[www.magnetic-mt.cz](http://www.magnetic-mt.cz)



Magnetic

## Seřízení Magneticu

Magnetic má seřízení pomocí imbus klíče (**KROK 1**), každá otáčka imbus klíče o 360 stupňů = výsun 1 mm desky s magnety.

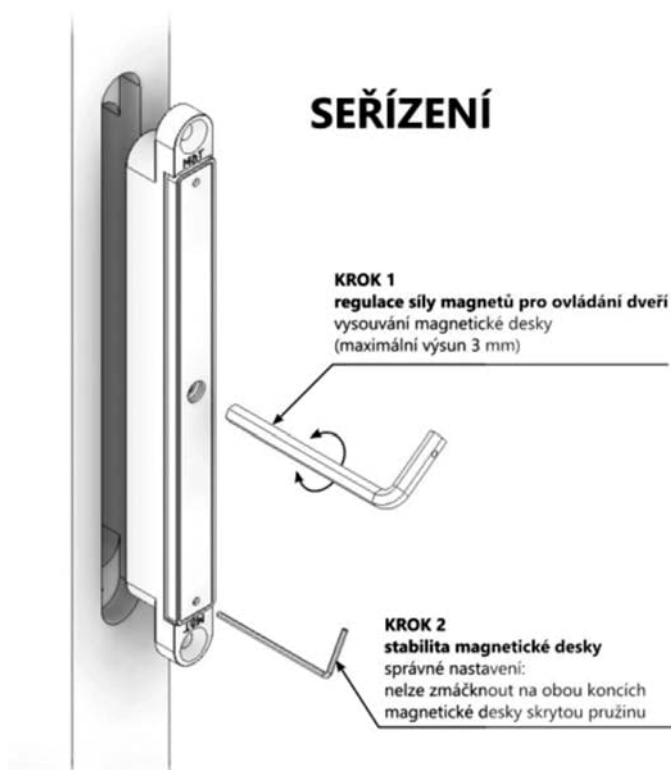

Po seřízení síly magnetů následuje **KROK 2** tj. zajištění stability magnetické desky na obou koncích pomocí malého imbusu.

Správné nastavení: nelze zmáčknout na obou koncích magnetické desky skrytou pružinku.

## KOLEKCE Magnetic



K magnetickému systému jsme navrhli inovativní úchopná madla, připravená pro jednoduché, ale účinné ovládání dveří.

Velkou předností modelů je propracovaná ergonomie a mimořádná stabilita na dveřích zaručující maximální komfort při ovládání.

Všechny modely jsou připraveny vždy ve více povrchových úpravách pro perfektní sjednocení s povrchem dveří a celým interiérem.

Veškeré modely madel jsou připraveny jak pro otočné, tak pro posuvné dveře.

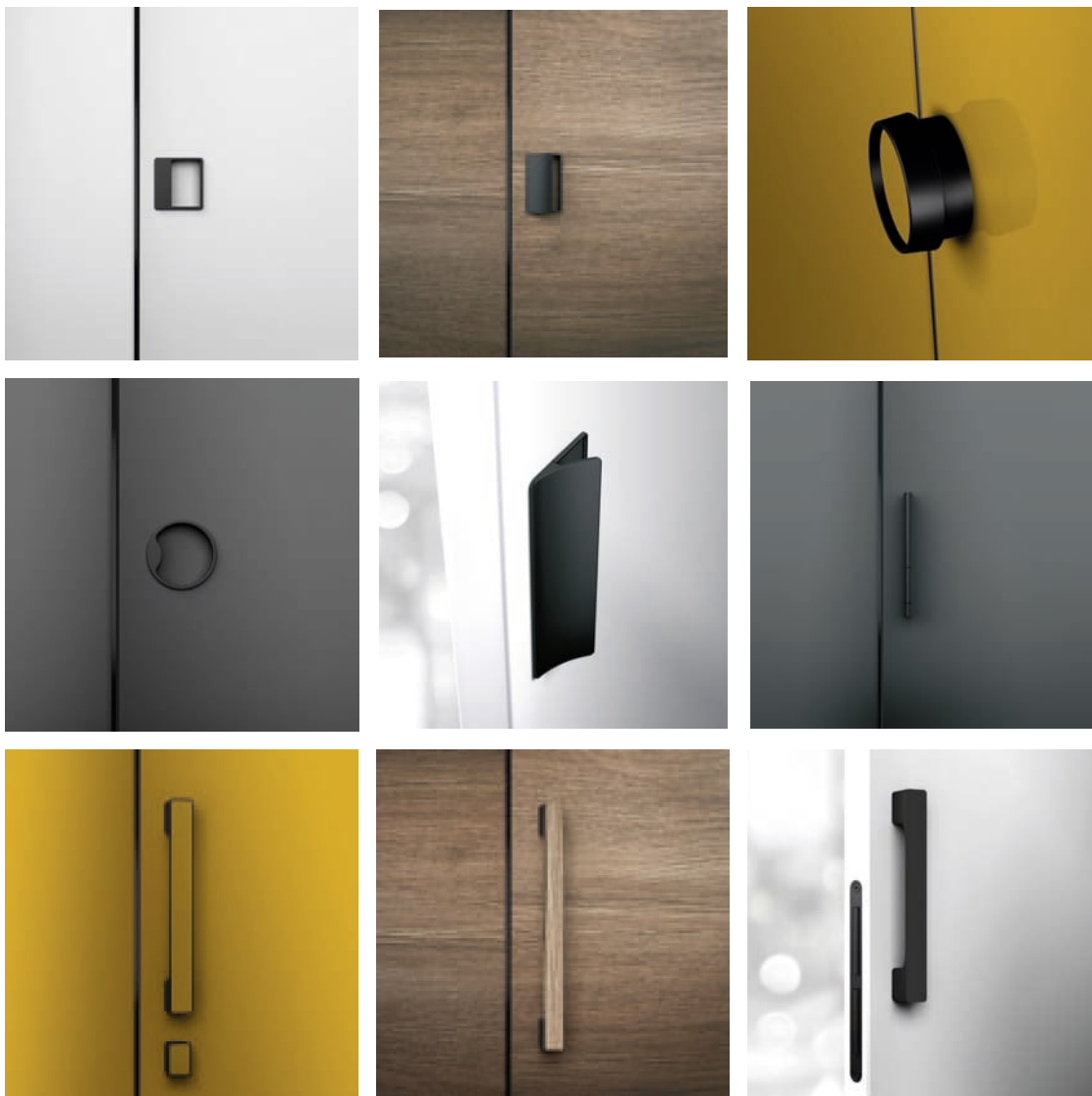



### Joo

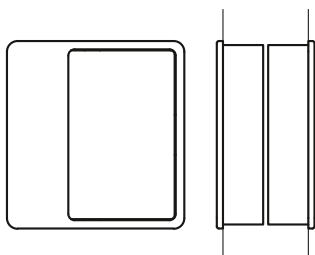

84×89 mm (Š×V), výstup nad povrch dveří 3 mm

### Oko

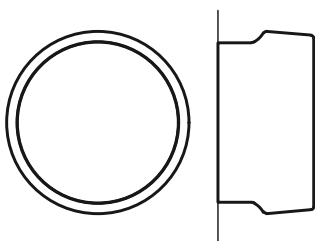

84×89 mm (Š×V), výstup nad povrch dveří 33 mm

### Uff

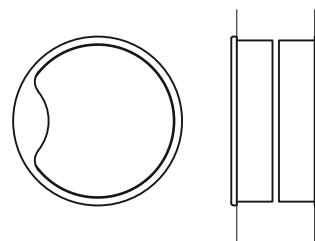

Ø 90 mm, výstup nad povrch dveří 3 mm

### Yes!

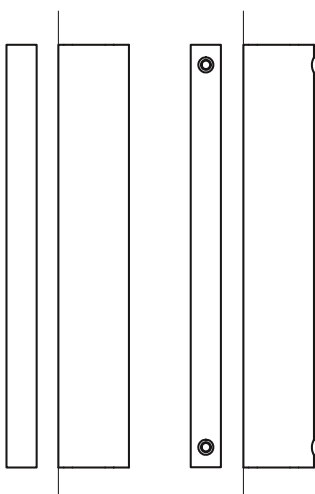

délky: 110, 210, 310, 610, 910 mm  
šířka: 15 mm  
výstup nad povrch dveří 35 mm

### Konzerva 110

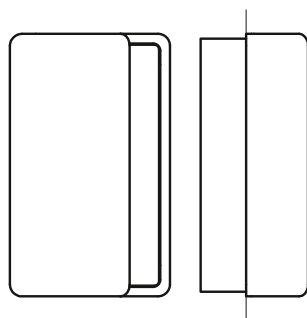

67×110 mm (Š×V), výstup nad povrch dveří 25 mm

[www.magnetic-mt.cz](http://www.magnetic-mt.cz)

### Konzerva 220

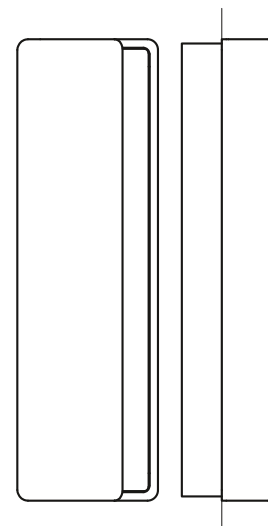

67×220 mm (Š×V), výstup nad povrch dveří 25 mm

### Minimal

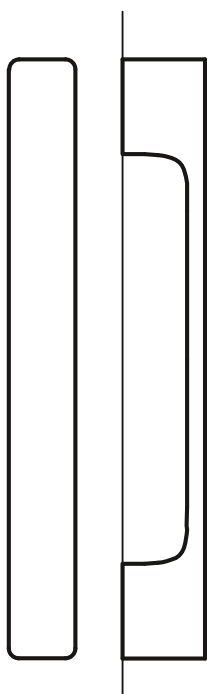

33×297 mm (Š×V), výstup nad povrch dveří 40 mm

### Maximal

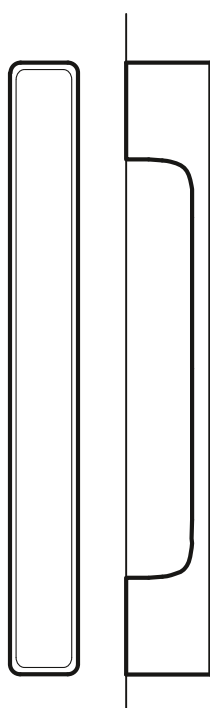

33×297 mm (Š×V), výstup nad povrch dveří 40 mm

### Mimolimit

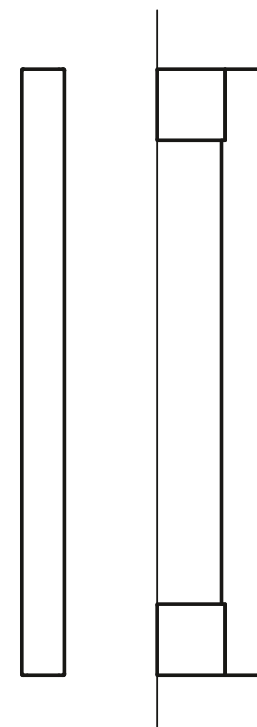

šířka 24 mm, výstup nad povrch dveří 61 mm



reddot winner 2020



Příbuzný sortiment

Magnetic



Neviditelné zárubně



Zapuštěné podlahové lišty



Posuvný systém Minima



## Ovládací madla k systému MAGNETIC

K magnetickému systému jsme navrhli inovativní úchopná madla, připravená pro jednoduché, ale účinné ovládání dveří. Velkou předností modelů je propracovaná ergonomie a mimořádná stabilita na dveřích zaručující maximální komfort při ovládání. Všechny modely jsou připraveny vždy ve více povrchových úpravách pro perfektní sjednocení s povrchem dveří a celým interiérem. Tím jsme docílili dokonalého celku, kdy u vybraných modelů madel tj. JOO, UFF, KONZERVA 110 a KONZERVA 220, dokážeme pomocí magnetických destiček vyplnit ovládací prostor madla identickým povrchem s dveřmi a tak připravit efekt částečně skrytého madla, kdy zůstává viditelná pouze okrajová kontura madla + úchopná plocha, vše ostatní je skryto ve dveřích. Součástí madla YES! je integrované zamykání WC/koupelna, což přináší dosud nepoznaný dojem. Pro svůj vyjimečný design obdržela madla Konzerva 220 a YES! prestižní mezinárodní cenu za design RED DOT Design Award 2020.

Veškeré modely madel jsou připraveny jak pro otočné, tak pro posuvné dveře.

Materiál: masivní mosaz 

Povrchy: SNI, Cr, Cr-K, Ms-L, Ms-A, TiN-C, TiN-K, TiN-B, TiN-A

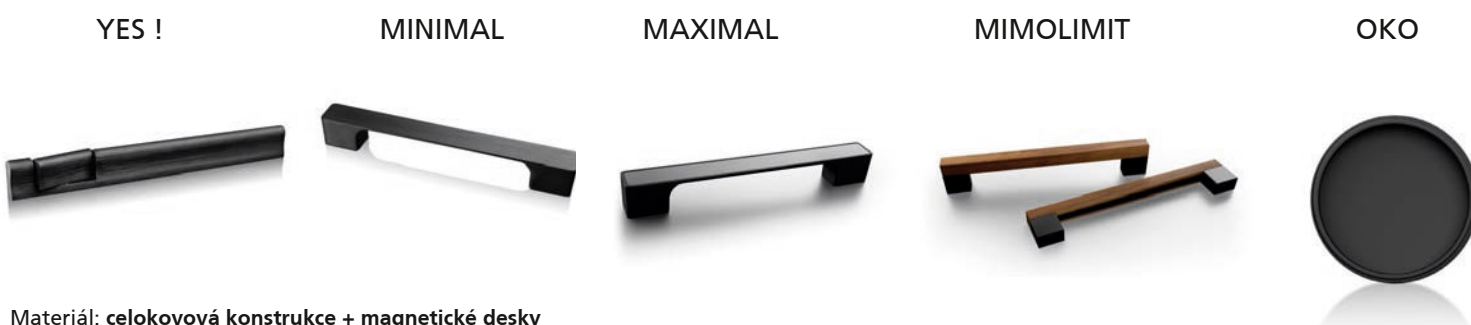

Materiál: celokovová konstrukce + magnetické desky

Povrchy: SNI, Cr, TiN-K





### konstrukční varianty

- sady madel se zamykáním jsou dodávány vždy v ceně se zámkem
- povrch dodávaného čela zámku k madlu je uveden v tabulkách cen a EAN kódů vedle povrchu madla za lomítkem
- zapuštěná madla jsou montážně připravena na dveře od tl. 38 mm
- madla Minimal, Maximal, Mimolimit, OKO, YES! dodáváme ve variantě oboustranné i jednostranné
- madla UFF, JOO, Konzerva 110, Konzerva 220 ve variantě oboustranné
- výkresy vrtání, frézování na [www.kliky-mt.cz/montaze-kovani](http://www.kliky-mt.cz/montaze-kovani)
- záruka 3 roky, titany 15 let, madla z masivní mosazi bez povrchu – doživotní záruka

roky **3 garance** | let **15 garance**

 Ochranné známky – registrované značky **MINIMAL®** **MAXIMAL®**

 **design** Chráněné průmyslové vzory madel  
JOO, UFF, Konzerva 110, Konzerva 220, OKO, Minimal, Maximal, Mimolimit, YES !

 **patent** Patenty  
• montážní konstrukce se systémem magnetických desek u madel JOO, UFF, KONZERVA



**Madlo Joo**  
+ magnetická výplň v povrchu madla

1880,- Kč  
79,- EUR

materiál: kovové tělo + magnetická výplň  
Kč povrch: TiN-K titan černý mat EUR

1880,-



79,-



**Magnetická výplň  
madla Joo**

220,- Kč  
9,2 EUR

materiál: magnetická výplň  
Kč povrch: bílá matná EUR

220,-



9,2



**Madlo Konzerva**  
+ magnetická výplň v povrchu madla

2810,- Kč  
118,- EUR

materiál: kovové tělo + magnetická výplň  
Kč povrch: TiN-K titan černý mat EUR

2810,-



118,-

4520,-



189,-

**Magnetická výplň  
madla Konzerva**

220,- Kč  
9,2 EUR

materiál: magnetická výplň  
Kč povrch: bílá matná EUR

220,-



9,2

330,-

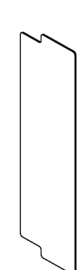

14,-

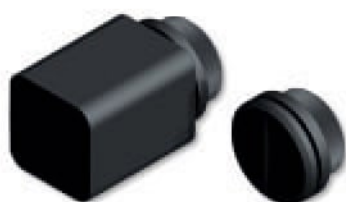

**WC hranaté bezrozetové**  
+ zámek + protiplech

1940,- Kč  
81,- EUR

materiál: masivní mosaz  
Kč povrch: TiN-K titan černý mat EUR

1940,-



81,-



## Výhodná cena setu

	TiN-K		SNi		K-industrial	
	cena / pár	EAN	cena / pár	EAN	cena / pár	EAN
Kč €	1880,- 79,-	108804	1380,- 58,-	108781	1880,- 79,-	169942



SNi 2900,- Kč  
TiN-K 3480,- Kč

Součástí výrobku a ceny je standardně výplň v povrchu madla.

Výhodná cena setu		SNi		TiN-K	
		cena	EAN	cena	EAN
Magnetic + mag. blok + madlo Joo	Kč €	2900,- 121,-	169966	3480,- 145,-	169980
Magnetic + mag. blok + madlo Joo WC	Kč €	3900,- 163,-	169973	4780,- 200,-	169997

Součástí setu je automaticky magnetický blok seřiditelný. V případě požadavku můžeme dodat magnetický blok standard bez seřízení, cena setu se nemění.

Nadstandardní výplň	Bílá matná		Bílá lesklá		Zakázková výroba	
	cena / pár	EAN	cena / pár	EAN	cena / pár	EAN
Kč €	220,- 9,2	110623	220,- 9,2	110630	290,- 13,-	110647

	TiN-K		SNi		K-industrial		
	cena / pár	EAN	cena / pár	EAN	cena / pár	EAN	
110 mm	Kč €	2810,- 118,-	108828	2110,- 88,-	108675	2810,- 118,-	170009
220 mm	Kč €	4520,- 189,-	108644	3520,- 147,-	108835	4520,- 189,-	170016

Součástí výrobku a ceny je standardně výplň v povrchu madla.

Nadstandardní výplň	Bílá matná		Bílá lesklá		Zakázková výroba		
	cena / pár	EAN	cena / pár	EAN	cena / pár	EAN	
110 mm	Kč €	220,- 9,2	110661	220,- 9,2	110678	290,- 13,-	110685
220 mm	Kč €	330,- 14,-	110692	330,- 14,-	110708	430,- 18,-	110715

	TiN-K / TiN-K		SNi / nerez		K-industrial / TiN-K	
	cena / set	EAN	cena / set	EAN	cena / set	EAN
Kč €	1940,- 81,-	108637	1290,- 54,-	109382	1940,- 81,-	170023

První uvedený povrch je povrch WC mechanismu, druhý za lomítkem je povrch čela zámku a protiplechu.



**Madlo Uff**  
+ magnetická výplň v povrchu madla

2700,- Kč  
113,- EUR

materiál: kovové tělo + magnetická výplň  
Kč povrch: TiN-K titan černý mat EUR

2700,-



113,-

**Magnetická výplň  
madla Uff**

220,- Kč  
9,2 EUR

materiál: magnetická výplň  
Kč povrch: bílá matná EUR

220,-



9,2



**Madlo Oko**

5640,- Kč  
235,- EUR

materiál: masivní mosaz + magnetická výplň  
Kč povrch: TiN-K titan černý mat EUR

5640,-



235,-

**Magnetická výplň  
Madlo Oko**

220,- Kč  
9,2 EUR

materiál: magnetická výplň  
Kč povrch: bílá matná EUR

220,-



9,2



**WC kulaté bezrozetové**  
+ zámek + protiplech

1940,- Kč  
81,- EUR

materiál: masivní mosaz  
Kč povrch: TiN-K titan černý mat EUR

1940,-



81,-

	TiN-K		Sni		K-industrial	
	cena / pár	EAN	cena / pár	EAN	cena / pár	EAN
Kč €	2700,- 113,-	108873	1840,- 77,-	108859	2700,- 113,-	169959

Součástí výrobku a ceny je standardně výplň v povrchu madla.

Nadstandardní výplň	Bílá matná		Bílá lesklá		Zakázková výroba	
	cena / pár	EAN	cena / pár	EAN	cena / pár	EAN
Kč €	220,- 9,2	110722	220,- 9,2	110739	290,- 13,-	110746



	TiN-K		Sni		Sni - broušeno		Ms-A		Ms-L	
	cena / pár	EAN	cena / pár	EAN	cena / pár	EAN	cena / pár	EAN	cena / pár	EAN
Kč €	5640,- 235,-	111743	4350,- 182,-	111682	4440,- 185,-	111699	4670,- 195,-	111774	4670,- 195,-	111712

	Cr		Cr-K		TiN-C		TiN-B		TiN-A	
	cena / pár	EAN	cena / pár	EAN	cena / pár	EAN	cena / pár	EAN	cena / pár	EAN
Kč €	4670,- 195,-	111705	6230,- 260,-	111729	5640,- 235,-	111736	5640,- 235,-	111750	5640,- 235,-	111767

Madlo Oko je dodáváno bez vnitřní magnetické volitelné výplně, která se objednává samostatně.

	Bílá matná		Sni		Cr		TiN-K		Bílá lesklá	
	cena / pár	EAN	cena / pár	EAN	cena / pár	EAN	cena / pár	EAN	cena / pár	EAN
Kč €	220,- 9,2	111910	220,- 9,2	111880	220,- 9,2	111897	290,- 13,-	111903	220,- 9,2	111927

	TiN-C		TiN-A		TiN-B	
	cena / pár	EAN	cena / pár	EAN	cena / pár	EAN
Kč €	290,- 13,-	111934	290,- 13,-	111941	290,- 13,-	111958

	TiN-K / TiN-K		Sni / nerez		K-industrial / TiN-K	
	cena / set	EAN	cena / set	EAN	cena / set	EAN
Kč €	1940,- 81,-	110777	1290,- 54,-	110753	1940,- 81,-	170030

Další povrchy WC  
na [www.kliky-mt.cz/katalog](http://www.kliky-mt.cz/katalog).

První uvedený povrch je povrch WC mechanismu, druhý za lomítkem je povrch čela zámku a protiplechu.







katalog YES!

**Madlo Yes! s otvorem**

5240,- Kč  
219,- EUR



materiál: masivní mosaz  
povrch: TiN-K titan černý mat **EUR**



Kč		EUR
5240,-		219,-
6310,-		263,-
7690,-		321,-
11530,-		481,-
15070,-		628,-

**Madlo Yes! WC s otvorem  
+ zámek + protiplech**

9390,- Kč  
392,- EUR



materiál: masivní mosaz  
povrch: TiN-K titan černý mat **EUR**

Kč		EUR
9390,-		392,-
10760,-		449,-
14600,-		609,-
18140,-		756,-



		TiN-K		SNI		SNI - broušeno		Ms-A		Ms-L	
		cena / pár	EAN	cena / pár	EAN	cena / pár	EAN	cena / pár	EAN	cena / pár	EAN
110 mm	Kč €	5240,- 219,-	113914	4010,- 168,-	113563	4180,- 175,-	113617	4620,- 193,-	113815	4620,- 193,-	113761
210 mm	Kč €	6310,- 263,-	113921	5080,- 212,-	113570	5240,- 219,-	113624	5710,- 238,-	113822	5710,- 238,-	113778
310 mm	Kč €	7690,- 321,-	113938	6310,- 263,-	113587	6480,- 270,-	113631	6920,- 289,-	113839	6920,- 289,-	113785
610 mm	Kč €	11530,- 481,-	113945	9230,- 385,-	113594	9390,- 392,-	113648			10150,- 423,-	113792
910 mm	Kč €	15070,- 628,-	113952	12930,- 539,-	113600	13220,- 551,-	113655			13690,- 571,-	113808

		Cr		Cr-K		TiN-C		TiN-B		TiN-A	
		cena / pár	EAN	cena / pár	EAN	cena / pár	EAN	cena / pár	EAN	cena / pár	EAN
110 mm	Kč €	4480,- 187,-	113662	5860,- 245,-	113716	5240,- 219,-	113860	5240,- 219,-	113969	5240,- 219,-	114010
210 mm	Kč €	5560,- 232,-	113679	7240,- 302,-	113723	6310,- 263,-	113877	6310,- 263,-	113976	6310,- 263,-	114027
310 mm	Kč €	6780,- 283,-	113686	8930,- 373,-	113730	7690,- 321,-	113884	7690,- 321,-	113983	7690,- 321,-	114034
610 mm	Kč €	9850,- 411,-	113693	13530,- 564,-	113747	11530,- 481,-	113891	11530,- 481,-	113990	11530,- 481,-	114041
910 mm	Kč €	13690,- 571,-	113709	17680,- 737,-	113754	15070,- 628,-	113907	15070,- 628,-	114003	15070,- 628,-	114058

Pro montáž na skleněné dveře je třeba doobjednat montážní materiál pro madlo Yes! na sklo str. 249.



		TiN-K / TiN-K		SNI / nerez		SNI - br. / nerez		Ms-A / TiN-K		Ms-L / TiN-K	
		cena / set	EAN	cena / set	EAN	cena / set	EAN	cena / set	EAN	cena / set	EAN
210 mm	Kč €	9390,- 392,-	114348	8160,- 340,-	114065	8320,- 347,-	114102	8780,- 366,-	114263	8780,- 366,-	114225
310 mm	Kč €	10760,- 449,-	114355	9390,- 392,-	114072	9540,- 398,-	114119	9990,- 417,-	114270	9990,- 417,-	114232
610 mm	Kč €	14600,- 609,-	114362	12300,- 513,-	114089	12450,- 519,-	114126			13220,- 551,-	114249
910 mm	Kč €	18140,- 756,-	114379	15990,- 667,-	114096	16300,- 680,-	114133			16760,- 699,-	114256

		Cr / nerez		Cr-K / TiN-K		TiN-C / nerez		TiN-B / TiN-K		TiN-A / TiN-K	
		cena / set	EAN	cena / set	EAN	cena / set	EAN	cena / set	EAN	cena / set	EAN
210 mm	Kč €	8610,- 359,-	114140	10920,- 455,-	114188	9390,- 392,-	114300	9390,- 392,-	114386	9390,- 392,-	114423
310 mm	Kč €	9850,- 411,-	114157	12450,- 519,-	114195	10760,- 449,-	114317	10760,- 449,-	114393	10760,- 449,-	114430
610 mm	Kč €	12930,- 539,-	114164	15220,- 635,-	114201	14600,- 609,-	114324	14600,- 609,-	114409	14600,- 609,-	114447
910 mm	Kč €	16760,- 699,-	114171	21360,- 890,-	114218	18140,- 756,-	114331	18140,- 756,-	114416	18140,- 756,-	114454



První uvedený povrch je povrch madla, druhý za lomítkem je povrch čela zámku a protiplechu.

**Madlo Yes! WC double s otvorem**  
+ zámek + protiplech



10320,- Kč  
430,- EUR

materiál: masivní mosaz  
povrch: TiN-K titan černý mat

Kč		EUR
10320,-		430,-
11700,-		488,-
15520,-		647,-
19060,-		795,-

**Madlo Yes!**  
jednostranné s otvorem



2630,- Kč  
110,- EUR

materiál: masivní mosaz  
povrch: TiN-K titan černý mat

Kč		EUR
2630,-		110,-
3160,-		132,-
3850,-		161,-
5780,-		241,-
7550,-		315,-



		TiN-K / TiN-K		Sni / nerez		Sni - br. / nerez		Ms-A / TiN-K		Ms-L / TiN-K	
		cena / set	EAN	cena / set	EAN	cena / set	EAN	cena / set	EAN	cena / set	EAN
210 mm	Kč €	10320,- 430,-	126525	9080,- 379,-	126242	9230,- 385,-	126280	9680,- 404,-	126440	9680,- 404,-	126402
310 mm	Kč €	11700,- 488,-	126532	10320,- 430,-	126259	10460,- 436,-	126297	10920,- 455,-	126457	10920,- 455,-	126419
610 mm	Kč €	15520,- 647,-	126549	13220,- 551,-	126266	13390,- 558,-	126303			14150,- 590,-	126426
910 mm	Kč €	19060,- 795,-	126556	16900,- 705,-	126273	17220,- 718,-	126310			17680,- 737,-	126433

		Cr / nerez		Cr-K / TiN-K		TiN-C / nerez		TiN-B / TiN-K		TiN-A / TiN-K	
		cena / set	EAN	cena / set	EAN	cena / set	EAN	cena / set	EAN	cena / set	EAN
210 mm	Kč €	9540,- 398,-	126327	11850,- 494,-	126365	10320,- 430,-	126488	10320,- 430,-	126563	10320,- 430,-	126600
310 mm	Kč €	10760,- 449,-	126334	13390,- 558,-	126372	11700,- 488,-	126495	11700,- 488,-	126570	11700,- 488,-	126617
610 mm	Kč €	13830,- 577,-	126341	16130,- 673,-	126389	15520,- 647,-	126501	15520,- 647,-	126587	15520,- 647,-	126624
910 mm	Kč €	17680,- 737,-	126358	22290,- 929,-	126396	19060,- 795,-	126518	19060,- 795,-	126594	19060,- 795,-	126631

První uvedený povrch je povrch madla, druhý za lomítkem je povrch čela zámku a protiplechu.



		TiN-K		Sni		Sni - broušeno		Ms-A		Ms-L	
		cena / ks	EAN	cena / ks	EAN	cena / ks	EAN	cena / ks	EAN	cena / ks	EAN
110 mm	Kč €	2630,- 110,-	124033	2020,- 85,-	123685	2100,- 88,-	123739	2320,- 97,-	123937	2320,- 97,-	123883
210 mm	Kč €	3160,- 132,-	124040	2550,- 107,-	123692	2630,- 110,-	123746	2870,- 120,-	123944	2870,- 120,-	123890
310 mm	Kč €	3850,- 161,-	124057	3160,- 132,-	123708	3250,- 136,-	123753	3480,- 145,-	123951	3480,- 145,-	123906
610 mm	Kč €	5780,- 241,-	124064	4620,- 193,-	123715	4710,- 197,-	123760			5080,- 212,-	123913
910 mm	Kč €	7550,- 315,-	124071	6480,- 270,-	123722	6620,- 276,-	123777			6850,- 286,-	123920

		Cr		Cr-K		TiN-C		TiN-B		TiN-A	
		cena / ks	EAN	cena / ks	EAN	cena / ks	EAN	cena / ks	EAN	cena / ks	EAN
110 mm	Kč €	2240,- 94,-	123784	2940,- 123,-	123838	2630,- 110,-	123982	2630,- 110,-	124088	2630,- 110,-	124132
210 mm	Kč €	2790,- 117,-	123791	3630,- 152,-	123845	3160,- 132,-	123999	3160,- 132,-	124095	3160,- 132,-	124149
310 mm	Kč €	3410,- 143,-	123807	4480,- 187,-	123852	3850,- 161,-	124002	3850,- 161,-	124101	3850,- 161,-	124156
610 mm	Kč €	4930,- 206,-	123814	6780,- 283,-	123869	5780,- 241,-	124019	5780,- 241,-	124118	5780,- 241,-	124163
910 mm	Kč €	6850,- 286,-	123821	8860,- 370,-	123876	7550,- 315,-	124026	7550,- 315,-	124125	7550,- 315,-	124170

Montážní materiál k madlu Yes! na sklo		Sni		Cr		TiN-C		TiN-K		TiN-B		TiN-A	
		cena / sada	EAN	cena / sada	EAN	cena / sada	EAN	cena / sada	EAN	cena / sada	EAN	cena / sada	EAN
na sklo 8 - 12 mm	Kč €	370,- 16,-	112511	370,- 16,-	155495	480,- 20,-	155501	480,- 20,-	155518	480,- 20,-	155525	480,- 20,-	155532

Pro montáž na skleněné dveře je třeba doobjednat montážní materiál pro madlo Yes! na sklo.



**Madlo Yes!**

4930,- Kč  
206,- EUR

materiál: masivní mosaz  
povrch: TiN-K titan černý mat

Kč	EUR
4930,-	206,-
6020,-	251,-
7380,-	308,-
11230,-	468,-
14760,-	615,-



**Madlo Yes! WC**  
+ zámek + protiplech

9080,- Kč  
379,- EUR

materiál: masivní mosaz  
povrch: TiN-K titan černý mat

Kč	EUR
9080,-	379,-
10460,-	436,-
14290,-	596,-
17830,-	743,-





	TiN-K		SNI		SNI - broušeno		Ms-A		Ms-L		
	cena / pár	EAN	cena / pár	EAN	cena / pár	EAN	cena / pár	EAN	cena / pár	EAN	
110 mm	Kč €	4930,- 206,-	111132	3710,- 155,-	110784	3850,- 161,-	110838	4320,- 180,-	111033	4320,- 180,-	110982
210 mm	Kč €	6020,- 251,-	111149	4790,- 200,-	110791	4930,- 206,-	110845	5390,- 225,-	111040	5390,- 225,-	110999
310 mm	Kč €	7380,- 308,-	111156	6020,- 251,-	110807	6160,- 257,-	110852	6620,- 276,-	111057	6620,- 276,-	111002
610 mm	Kč €	11230,- 468,-	111163	8930,- 373,-	110814	9080,- 379,-	110869			9850,- 411,-	111019
910 mm	Kč €	14760,- 615,-	111170	12620,- 526,-	110821	12930,- 539,-	110876			13390,- 558,-	111026

	Cr		Cr-K		TiN-C		TiN-B		TiN-A		
	cena / pár	EAN	cena / pár	EAN	cena / pár	EAN	cena / pár	EAN	cena / pár	EAN	
110 mm	Kč €	4180,- 175,-	110883	5560,- 232,-	110937	4930,- 206,-	111088	4930,- 206,-	111187	4930,- 206,-	111231
210 mm	Kč €	5240,- 219,-	110890	6920,- 289,-	110944	6020,- 251,-	111095	6020,- 251,-	111194	6020,- 251,-	111248
310 mm	Kč €	6480,- 270,-	110906	8610,- 359,-	110951	7380,- 308,-	111101	7380,- 308,-	111200	7380,- 308,-	111255
610 mm	Kč €	9540,- 398,-	110913	13220,- 551,-	110968	11230,- 468,-	111118	11230,- 468,-	111217	11230,- 468,-	111262
910 mm	Kč €	13390,- 558,-	110920	17370,- 724,-	110975	14760,- 615,-	111125	14760,- 615,-	111224	14760,- 615,-	111279

Pro montáž na skleněné dveře je třeba doobjednat montážní materiál pro madlo Yes! na sklo str. 245.



	TiN-K / TiN-K		SNI / nerez		SNI - br. / nerez		Ms-A / TiN-K		Ms-L / TiN-K		
	cena / set	EAN	cena / set	EAN	cena / set	EAN	cena / set	EAN	cena / set	EAN	
210 mm	Kč €	9080,- 379,-	111569	7860,- 328,-	111286	8010,- 334,-	111323	8460,- 353,-	111484	8460,- 353,-	111446
310 mm	Kč €	10460,- 436,-	111576	9080,- 379,-	110593	9230,- 385,-	111330	9680,- 404,-	111491	9680,- 404,-	111453
610 mm	Kč €	14290,- 596,-	111583	11990,- 500,-	111309	12150,- 507,-	111347			12930,- 539,-	111460
910 mm	Kč €	17830,- 743,-	111590	15690,- 654,-	111316	15990,- 667,-	111354			16460,- 686,-	111477

	Cr / nerez		Cr-K / TiN-K		TiN-C / nerez		TiN-B / TiN-K		TiN-A / TiN-K		
	cena / set	EAN	cena / set	EAN	cena / set	EAN	cena / set	EAN	cena / set	EAN	
210 mm	Kč €	8320,- 347,-	111361	10630,- 443,-	111408	9080,- 379,-	111521	9080,- 379,-	111606	9080,- 379,-	111644
310 mm	Kč €	9540,- 398,-	111378	12150,- 507,-	111415	10460,- 436,-	111538	10460,- 436,-	111613	10460,- 436,-	111651
610 mm	Kč €	12620,- 526,-	111385	14920,- 622,-	111422	14290,- 596,-	111545	14290,- 596,-	111620	14290,- 596,-	111668
910 mm	Kč €	16460,- 686,-	111392	21060,- 878,-	111439	17830,- 743,-	111552	17830,- 743,-	111637	17830,- 743,-	111675



První uvedený povrch je povrch madla, druhý za lomítkem je povrch čela zámku a protiplechu.



**Madlo Yes! WC double**  
+ zámek + protiplech

9990,- Kč  
417,- EUR

materiál: masivní mosaz  
Kč povrch: TiN-K titan černý mat EUR

9990,-		417,-
11380,-		475,-
15220,-		635,-
18760,-		782,-



**Madlo Yes! jednostranné**

2470,- Kč  
103,- EUR

materiál: masivní mosaz  
Kč povrch: TiN-K titan černý mat EUR

2470,-		103,-
3020,-		126,-
3710,-		155,-
5620,-		235,-
7380,-		308,-





		TiN-K / TiN-K		Sni / nerez		Sni - br. / nerez		Ms-A / TiN-K		Ms-L / TiN-K	
		cena / set	EAN	cena / set	EAN	cena / set	EAN	cena / set	EAN	cena / set	EAN
210 mm	Kč €	9990,- 417,-	126129	8780,- 366,-	125849	8930,- 373,-	125887	9390,- 392,-	126044	9390,- 392,-	126006
310 mm	Kč €	11380,- 475,-	126136	9990,- 417,-	125856	10150,- 423,-	125894	10630,- 443,-	126051	10630,- 443,-	126013
610 mm	Kč €	15220,- 635,-	126143	12930,- 539,-	125863	13060,- 545,-	125900			13830,- 577,-	126020
910 mm	Kč €	18760,- 782,-	126150	16590,- 692,-	125870	16900,- 705,-	125917			17370,- 724,-	126037

		Cr / nerez		Cr-K / TiN-K		TiN-C / nerez		TiN-B / TiN-K		TiN-A / TiN-K	
		cena / set	EAN	cena / set	EAN	cena / set	EAN	cena / set	EAN	cena / set	EAN
210 mm	Kč €	9230,- 385,-	125924	11530,- 481,-	125962	9990,- 417,-	126082	9990,- 417,-	126167	9990,- 417,-	126204
310 mm	Kč €	10460,- 436,-	125931	13060,- 545,-	125979	11380,- 475,-	126099	11380,- 475,-	126174	11380,- 475,-	126211
610 mm	Kč €	13530,- 564,-	125948	15830,- 660,-	125986	15220,- 635,-	126105	15220,- 635,-	126181	15220,- 635,-	126228
910 mm	Kč €	17370,- 724,-	125955	21970,- 916,-	125993	18760,- 782,-	126112	18760,- 782,-	126198	18760,- 782,-	126235

První uvedený povrch je povrch madla, druhý za lomítkem je povrch čela zámku a protiplechu.



		TiN-K		Sni		Sni - broušeno		Ms-A		Ms-L	
		cena / ks	EAN	cena / ks	EAN	cena / ks	EAN	cena / ks	EAN	cena / ks	EAN
110 mm	Kč €	2470,- 103,-	123531	1870,- 78,-	123180	1940,- 81,-	123234	2170,- 91,-	123432	2170,- 91,-	123388
210 mm	Kč €	3020,- 126,-	123548	2410,- 101,-	123197	2470,- 103,-	123241	2710,- 113,-	123449	2710,- 113,-	123395
310 mm	Kč €	3710,- 155,-	123555	3020,- 126,-	123203	3090,- 129,-	123258	3320,- 139,-	123456	3320,- 139,-	123401
610 mm	Kč €	5620,- 235,-	123562	4480,- 187,-	123210	4540,- 190,-	123265			4930,- 206,-	123418
910 mm	Kč €	7380,- 308,-	123579	6310,- 263,-	123227	6480,- 270,-	123272			6700,- 280,-	123425

		Cr		Cr-K		TiN-C		TiN-B		TiN-A	
		cena / ks	EAN	cena / ks	EAN	cena / ks	EAN	cena / ks	EAN	cena / ks	EAN
110 mm	Kč €	2100,- 88,-	123289	2790,- 117,-	123333	2470,- 103,-	123487	2470,- 103,-	123586	2470,- 103,-	123630
210 mm	Kč €	2630,- 110,-	123296	3480,- 145,-	123340	3020,- 126,-	123494	3020,- 126,-	123593	3020,- 126,-	123647
310 mm	Kč €	3250,- 136,-	123302	4320,- 180,-	123357	3710,- 155,-	123500	3710,- 155,-	123609	3710,- 155,-	123654
610 mm	Kč €	4790,- 200,-	123319	6620,- 276,-	123364	5620,- 235,-	123517	5620,- 235,-	123616	5620,- 235,-	123661
910 mm	Kč €	6700,- 280,-	123326	8690,- 363,-	123371	7380,- 308,-	123524	7380,- 308,-	123623	7380,- 308,-	123678

Montážní materiál k madlu Yes! na sklo		Sni		Cr		TiN-C		TiN-K		TiN-B		TiN-A	
		cena / sada	EAN	cena / sada	EAN	cena / sada	EAN	cena / sada	EAN	cena / sada	EAN	cena / sada	EAN
na sklo 8 - 12 mm	Kč €	370,- 16,-	112511	370,- 16,-	155495	480,- 20,-	155501	480,- 20,-	155518	480,- 20,-	155525	480,- 20,-	155532

Pro montáž na skleněné dveře je třeba doobjednat montážní materiál pro madlo Yes! na sklo.

Varianty provedení madla Yes!

**Madlo Yes!**

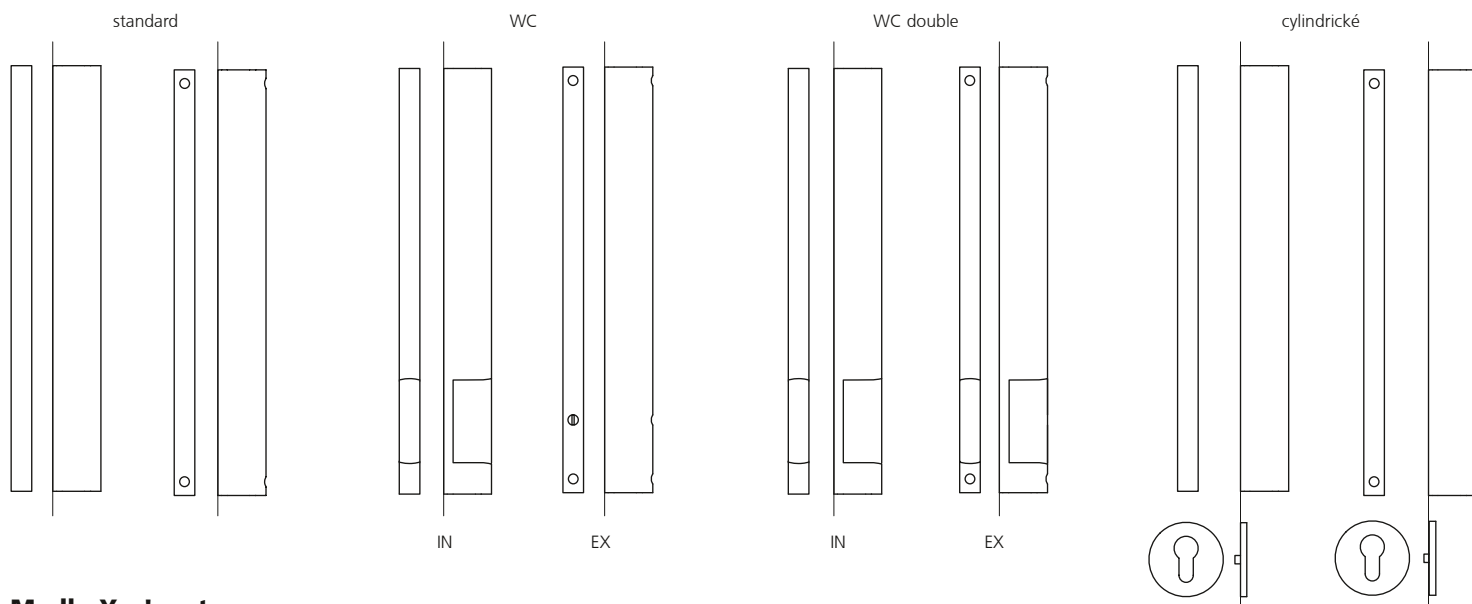

**Madlo Yes! s otvorem**

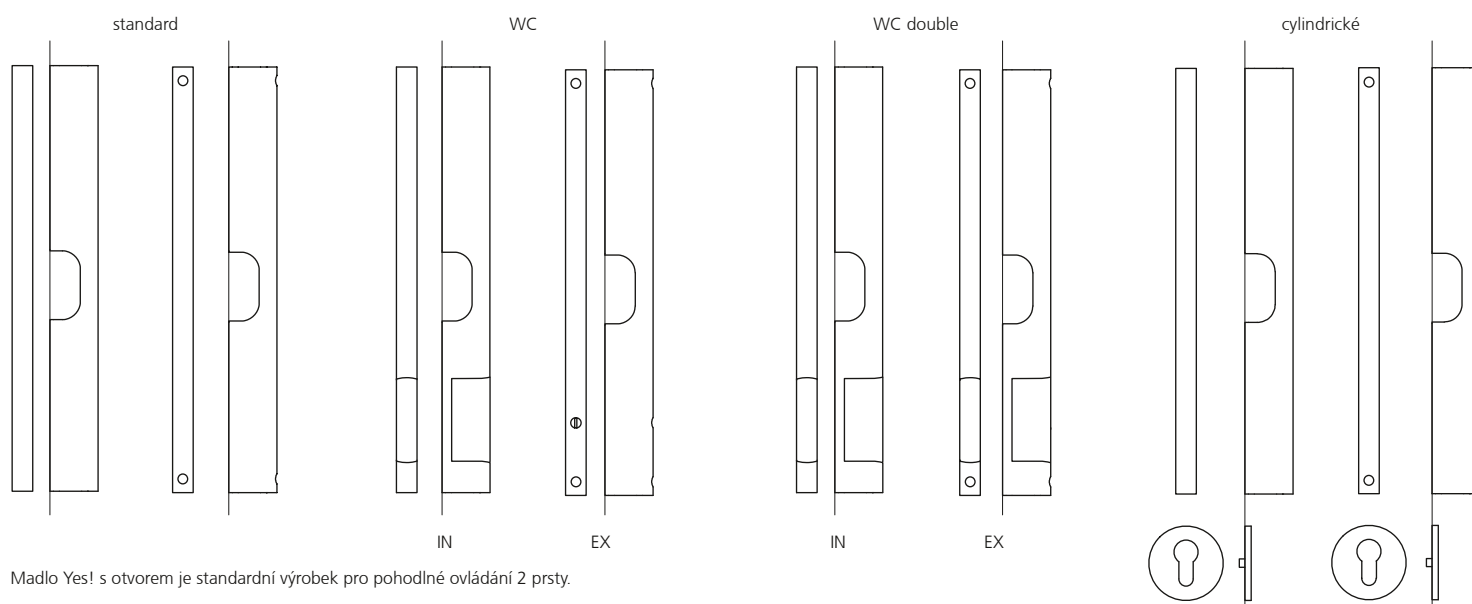

Madlo Yes! s otvorem je standardní výrobek pro pohodlné ovládání 2 prsty.

**Madlo Yes! s otvorem 90 mm  
pro celou ruku**

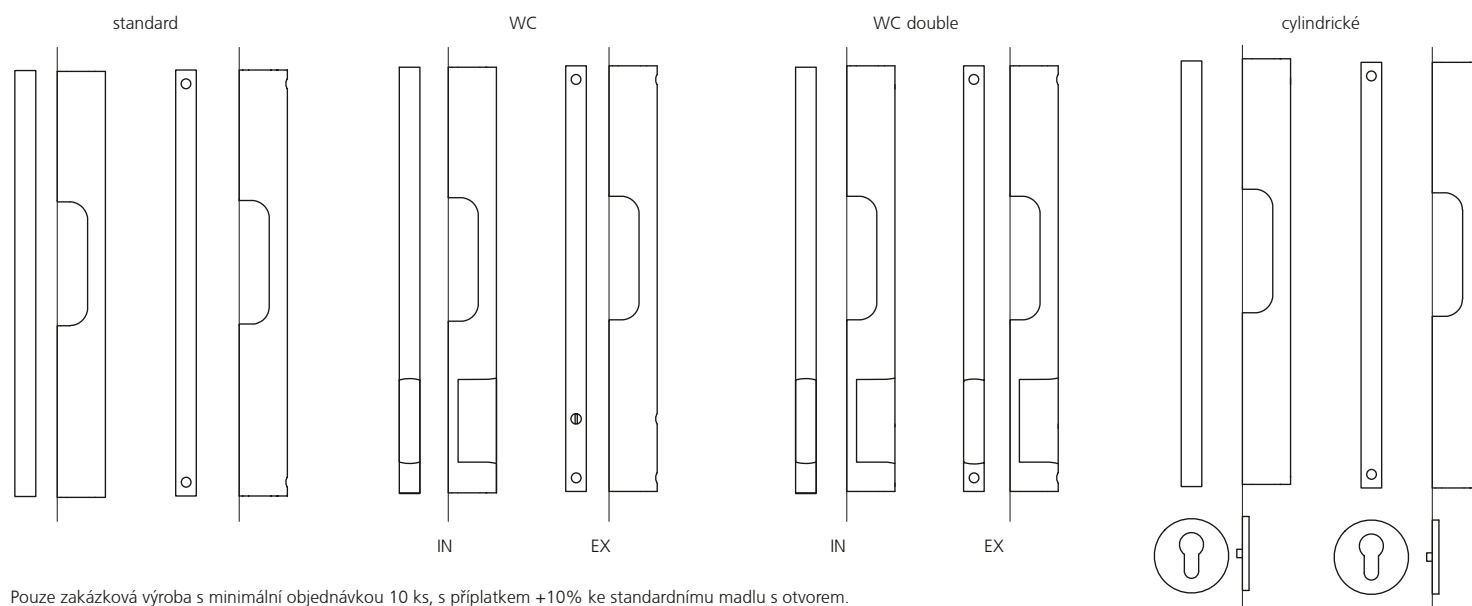

Pouze zakázková výroba s minimální objednávkou 10 ks, s příplatkem +10% ke standardnímu madlu s otvorem.



Šrouby k madlu Yes! na dřevěné dveře oboustranné madlo		SNi		Cr		TiN-C		TiN-K		TiN-B		TiN-A	
		cena / sada	EAN	cena / sada	EAN	cena / sada	EAN	cena / sada	EAN	cena / sada	EAN	cena / sada	EAN
tl. dveří	Kč	53,-	124774	53,-	155143	110,-	155211	110,-	155280	110,-	155358	110,-	155426
51 - 60 mm	€	2,3		2,3		4,6		4,6		4,6		4,6	
tl. dveří	Kč	53,-	155082	53,-	155150	110,-	155228	110,-	155297	110,-	155365	110,-	155433
61 - 70 mm	€	2,3		2,3		4,6		4,6		4,6		4,6	
tl. dveří	Kč	53,-	155099	53,-	155167	110,-	155235	110,-	155303	110,-	155372	110,-	155440
71 - 80 mm	€	2,3		2,3		4,6		4,6		4,6		4,6	
tl. dveří	Kč	80,-	155105	80,-	155174	140,-	155242	140,-	155310	140,-	155389	140,-	155457
81 - 90 mm	€	3,4		3,4		5,9		5,9		5,9		5,9	
tl. dveří	Kč	80,-	155112	80,-	155181	140,-	155259	140,-	155327	140,-	155396	140,-	155464
91 - 100 mm	€	3,4		3,4		5,9		5,9		5,9		5,9	
tl. dveří	Kč	80,-	155129	80,-	155198	140,-	155266	140,-	155334	140,-	155402	140,-	155471
101 - 110 mm	€	3,4		3,4		5,9		5,9		5,9		5,9	
tl. dveří	Kč	80,-	155136	80,-	155204	140,-	155273	140,-	155341	140,-	155419	140,-	155488
111 - 120 mm	€	3,4		3,4		5,9		5,9		5,9		5,9	

Šrouby pro tl. dveří 38 - 50 mm jsou v ceně madla a součástí dodávky madel.

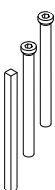

Montážní materiál k madlu Yes! WC		SNi		Cr		TiN-C		TiN-K		TiN-B		TiN-A	
		cena / sada	EAN	cena / sada	EAN	cena / sada	EAN	cena / sada	EAN	cena / sada	EAN	cena / sada	EAN
tl. dveří	Kč	430,-	124781	430,-	155549	530,-	155570	530,-	155600	530,-	155631	530,-	155662
46 - 50 mm	€	18,-		18,-		23,-		23,-		23,-		23,-	
tl. dveří	Kč	430,-	124798	430,-	155556	530,-	155587	530,-	155617	530,-	155648	530,-	155679
51 - 55 mm	€	18,-		18,-		23,-		23,-		23,-		23,-	
tl. dveří	Kč	430,-	124804	430,-	155563	530,-	155594	530,-	155624	530,-	155655	530,-	155686
56 - 60 mm	€	18,-		18,-		23,-		23,-		23,-		23,-	

Montážní materiál pro tl. dveří 38 - 45 mm je v ceně madla a součástí dodávky madel.

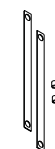

Montážní materiál k madlu Yes! na sklo		SNi		Cr		TiN-C		TiN-K		TiN-B		TiN-A	
		cena / sada	EAN	cena / sada	EAN	cena / sada	EAN	cena / sada	EAN	cena / sada	EAN	cena / sada	EAN
na sklo	Kč	370,-	112511	370,-	155495	480,-	155501	480,-	155518	480,-	155525	480,-	155532
8 - 12 mm	€	16,-		16,-		20,-		20,-		20,-		20,-	

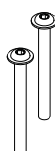

Šrouby k madlu Yes! na dřevěné dveře jednostranné madlo		cena	EAN
		sada	
tl. dveří	Kč	27,-	155068
46 - 55 mm	€	1,2	
tl. dveří	Kč	27,-	155075
56 - 65 mm	€	1,2	

Šrouby pro tl. dveří 38 - 45 mm jsou v ceně madla a součástí dodávky madel.

### Rozměrové varianty madla Yes!

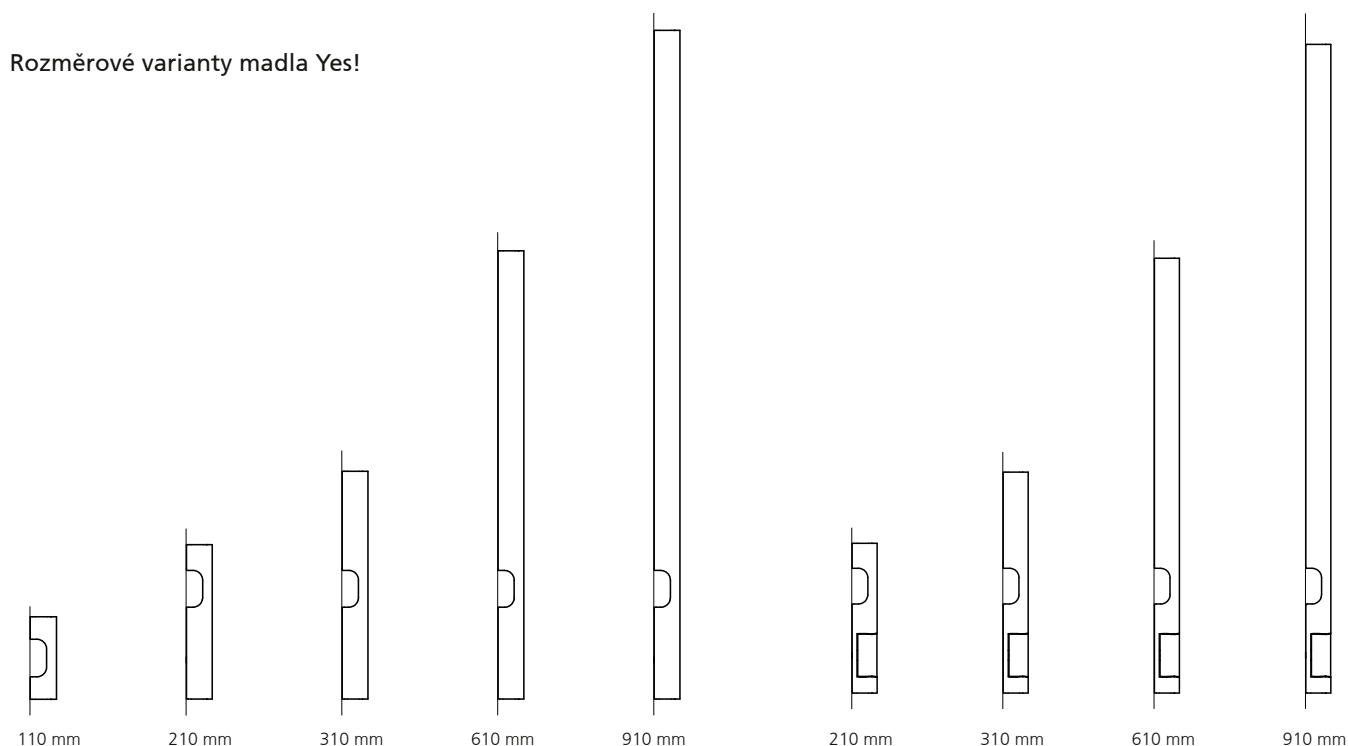

VOLNO





OBSAZENO

Součástí madla YES! je integrované zamykání WC/koupelna, což přináší dosud nepoznaný dojem.

Video na [www.magnetic-mt.cz](http://www.magnetic-mt.cz)



**Madlo Minimal**

15350,- Kč  
640,- EUR

materiál: masivní mosaz  
Kč povrch: TiN-K titan černý mat EUR

15350,-



640,-



**Madlo Minimal**  
+ zámek + protiplech

17890,- Kč  
746,- EUR

materiál: masivní mosaz  
Kč povrch: TiN-K titan černý mat EUR

17890,-

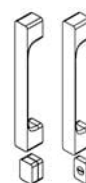

746,-

16720,-

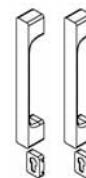

697,-



	TiN-K		SNI		SNI - broušeno		Ms		Ms-L		
	cena / pár	EAN	cena / pár	EAN	cena / pár	EAN	cena / pár	EAN	cena / pár	EAN	
oboustranné	Kč €	15350,- 640,-	002751	12260,- 511,-	002706	12610,- 526,-	002713	13000,- 542,-	058819	13000,- 542,-	058833

	Cr		TiN-C		TiN-B		TiN-A		
	cena / pár	EAN	cena / pár	EAN	cena / pár	EAN	cena / pár	EAN	
oboustranné	Kč €	13000,- 542,-	002720	15350,- 640,-	002737	15350,- 640,-	002744	15350,- 640,-	002768



	TiN-K / TiN-K		SNI / nerez		SNI - br. / nerez		Ms / TiN-K		Ms-L / TiN-K		
	cena / pár	EAN	cena / pár	EAN	cena / pár	EAN	cena / pár	EAN	cena / pár	EAN	
WC	Kč €	17890,- 746,-	112023	14380,- 600,-	111965	14720,- 614,-	111972	15110,- 630,-	111996	15110,- 630,-	112009
cylindrické	Kč €	16720,- 697,-	112115	13520,- 564,-	112054	13880,- 579,-	112061	14540,- 606,-	112085	14540,- 606,-	112092

	Cr / nerez		Cr-K / TiN-K		TiN-C / nerez		TiN-B / TiN-K		
	cena / pár	EAN	cena / pár	EAN	cena / pár	EAN	cena / pár	EAN	
WC	Kč €	15110,- 630,-	111989	20750,- 865,-	112047	17890,- 746,-	112016	17890,- 746,-	112030
cylindrické	Kč €	14540,- 606,-	112078	19490,- 813,-	112139	16720,- 697,-	112108	16720,- 697,-	112122

První uvedený povrch je povrch madla a WC mechanismu, druhý za lomítkem je povrch čela zámku a protiplechu.



**Madlo Maximal**  
(bez výplně)

15830,- Kč  
660,- EUR

materiál: masivní mosaz + výplň  
Kč povrch: TiN-K titan černý mat EUR

15830,-

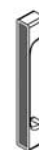

660,-

**Madlo Maximal**  
(bez výplně) + zámek + protiplech

18590,- Kč  
775,- EUR

materiál: masivní mosaz + výplň  
Kč povrch: TiN-K titan černý mat EUR

18590,-



775,-

17160,-



715,-



**Výplň madla**  
**Maximal**

630,- Kč  
27,- EUR

Kč EUR

630,-

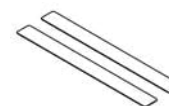

27,-

**Výplň WC**  
**Maximal**

160,- Kč  
6,7 EUR

Kč EUR

160,-



6,7





	TiN-K		SNI		SNI - broušeno		Ms		Ms-L		
	cena / pár	EAN	cena / pár	EAN	cena / pár	EAN	cena / pár	EAN	cena / pár	EAN	
oboustranné	Kč €	15830,- 660,-	002898	12680,- 529,-	002843	13040,- 544,-	002850	13390,- 558,-	058857	13390,- 558,-	058871

	Cr		TiN-C		TiN-B		TiN-A		
	cena / pár	EAN	cena / pár	EAN	cena / pár	EAN	cena / pár	EAN	
oboustranné	Kč €	13390,- 558,-	002867	15830,- 660,-	002874	15830,- 660,-	002881	15830,- 660,-	002904

Výplň do madla není součástí dodávky, objednává se samostatně.



	TiN-K / TiN-K		SNI / nerez		SNI - br. / nerez		Ms / TiN-K		Ms-L / TiN-K		
	cena / pár	EAN	cena / pár	EAN	cena / pár	EAN	cena / pár	EAN	cena / pár	EAN	
WC	Kč €	18590,- 775,-	112207	14790,- 617,-	112146	15140,- 631,-	112153	15600,- 650,-	112177	15600,- 650,-	112184
cyklindrické	Kč €	17160,- 715,-	112283	13940,- 581,-	112221	14170,- 591,-	112238	14900,- 621,-	112252	14900,- 621,-	112269

	Cr / nerez		TiN-C / nerez		TiN-B / TiN-K		
	cena / pár	EAN	cena / pár	EAN	cena / pár	EAN	
WC	Kč €	15600,- 650,-	112160	18590,- 775,-	112191	18590,- 775,-	112214
cyklindrické	Kč €	14900,- 621,-	112245	17160,- 715,-	112276	17160,- 715,-	112290

První uvedený povrch je povrch madla a WC mechanismu, druhý za lomítkem je povrch čela zámku a protiplechu. Výplň do madla a WC není součástí dodávky, objednává se samostatně.

	Bílá matná		Bílá lesklá		Dřevo		Barvy RAL		
	cena / pár	EAN	cena / pár	EAN	cena / pár	EAN	cena / pár	EAN	
	Kč €	630,- 27,-	111804	630,- 27,-	111811	630,- 27,-	002980	780,- 33,-	022520

	Bílá matná		Bílá lesklá		Dřevo		Barvy RAL		
	cena / ks	EAN	cena / ks	EAN	cena / ks	EAN	cena / ks	EAN	
	Kč €	160,- 6,7	111828	160,- 6,7	111835	160,- 6,7	000740	220,- 9,2	022490



**Madlo Mimolimit**  
(bez dřevěné části)

6690,- Kč  
279,- EUR

Kč	materiál: masivní mosaz povrch: TiN-K titan černý mat	EUR
6690,-		279,-
7590,-		317,-
10470,-		437,-
11200,-		467,-
14910,-		622,-
18600,-		775,-



**WC hranaté bezrozetové**  
+ zámek + protiplech (k madlu Mimolimit)

1940,- Kč  
81,- EUR

Kč	materiál: masivní mosaz povrch: TiN-K titan černý mat	EUR
1940,-		81,-



**Rozety cylindrické**  
+ zámek + protiplech (k madlu Mimolimit)

1830,- Kč  
77,- EUR

Kč	materiál: masivní mosaz povrch: TiN-K titan černý mat	EUR
1830,-		77,-



bělený dub

jilm

teak

**Dřevěná část**  
madla Mimolimit

1260,- Kč  
53,- EUR

Kč		EUR
1260,-		53,-
1850,-		78,-
2470,-		103,-
2740,-		115,-
3290,-		138,-
3700,-		155,-



rozteč / délka	TiN-K		SNI - broušeno		Cr		Ms		TiN-C		TiN-B		
	cena / ks	EAN	cena / ks	EAN	cena / ks	EAN	cena / ks	EAN	cena / ks	EAN	cena / ks	EAN	
300 / 340 mm	Kč €	6690,- 279,-	83363	4570,- 191,-	83301	4710,- 197,-	022209	4710,- 197,-	058895	6690,- 370,-	83349	6690,- 279,-	83387
600 / 640 mm	Kč €	7590,- 317,-	83370	5460,- 228,-	83318	5610,- 234,-	022216	5610,- 234,-	058901	7590,- 317,-	83356	7590,- 317,-	83394
900 / 940 mm	Kč €	10470,- 437,-	84056	8020,- 335,-	83974	8170,- 341,-	022223	8170,- 341,-	058918	10470,- 437,-	84018	10470,- 437,-	84094
1200 / 1240 mm	Kč €	11200,- 467,-	84063	9070,- 378,-	83981	9240,- 385,-	022230	9240,- 385,-	058925	11200,- 467,-	84025	11200,- 467,-	84100
1800 / 1840 mm	Kč €	14910,- 622,-	84070	11940,- 498,-	83998	12120,- 505,-	022247	12120,- 505,-	058932	14910,- 622,-	84032	14910,- 622,-	84117
2400 / 2440 mm	Kč €	18600,- 775,-	84087	14990,- 625,-	84001	15140,- 631,-	022254	15140,- 631,-	058949	18600,- 775,-	84049	18600,- 775,-	84124

Dřevěná část madla není součástí dodávky, objednává se samostatně.  
Cena uvedená v tabulce je za 1 ks. Oboustranné madlo jsou 2 ks = pár.



	TiN-K / TiN-K		SNI - br. / nerez		Cr / nerez		Ms / TiN-K		TiN-C / nerez		TiN-B / TiN-K	
	cena / pár	EAN	cena / pár	EAN	cena / pár	EAN	cena / pár	EAN	cena / pár	EAN	cena / pár	EAN
Kč €	1940,- 81,-	108637	1290,- 54,-	111293	1640,- 69,-	110654	1640,- 69,-	112313	1940,- 81,-	112320	1940,- 81,-	112337

První uvedený povrch je povrch WC mechanismu, druhý za lomítkem je povrch čela zámku a protiplechu.



	TiN-K / TiN-K		SNI - br. / nerez		Cr / nerez		Ms / TiN-K		TiN-C / nerez		TiN-B / TiN-K	
	cena / pár	EAN	cena / pár	EAN	cena / pár	EAN	cena / pár	EAN	cena / pár	EAN	cena / pár	EAN
Kč €	1830,- 77,-	112382	1270,- 53,-	112344	1400,- 59,-	112351	1700,- 71,-	112368	1830,- 77,-	112375	1830,- 77,-	112399

První uvedený povrch je povrch WC mechanismu, druhý za lomítkem je povrch čela zámku a protiplechu.

rozteč / délka	Teak		Jilm		Ořech		Dub		Dub bělený		
	cena / ks	EAN	cena / ks	EAN	cena / ks	EAN	cena / ks	EAN	cena / ks	EAN	
300 / 340 mm	Kč €	1260,- 53,-	83400	1030,- 43,-	83424	1030,- 43,-	83448	1030,- 43,-	83936	1150,- 48,-	83950
600 / 640 mm	Kč €	1850,- 78,-	83417	1540,- 65,-	83431	1540,- 65,-	83929	1540,- 65,-	83943	1700,- 71,-	83967
900 / 940 mm	Kč €	2470,- 103,-	84131	2050,- 86,-	84179	2050,- 86,-	84216	2050,- 86,-	84254	2270,- 95,-	84292
1200 / 1240 mm	Kč €	2740,- 115,-	84148	2410,- 101,-	84186	2410,- 101,-	84223	2410,- 101,-	84261	2650,- 111,-	84308
1800 / 1840 mm	Kč €	3290,- 138,-	84155	2740,- 115,-	84193	2740,- 115,-	84230	2740,- 115,-	84278	3020,- 126,-	84315
2400 / 2440 mm	Kč €	3700,- 155,-	84162	3090,- 129,-	84209	3090,- 129,-	84247	3090,- 129,-	84285	3400,- 142,-	84322

Cena uvedená v tabulce je za 1 ks. Oboustranné madlo jsou 2 ks = pár.



**WC bezrozetové**  
+ zámek + protiplech

1940,- Kč  
81,- EUR



materiál: masivní mosaz  
povrch: TiN-K titan černý mat **EUR**

1940,- 81,-



1940,- 81,-

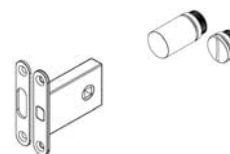

**WC s magnetickou rozetou**  
+ zámek + protiplech

2260,- Kč  
95,- EUR

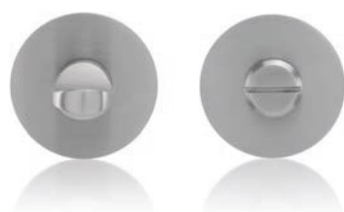

materiál: magnetická nerez ocel  
povrch: TiN-K titan černý mat **EUR**

2260,- 95,-

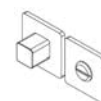

2110,- 88,-



**Magnetické rozety cylindrické**  
+ zámek + protiplech

1270,- Kč  
53,- EUR

materiál: magnetická nerez ocel  
povrch: TiN-K titan černý mat **EUR**

1270,- 53,-



1140,- 48,-



1270,- 53,-

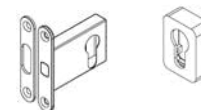

**Protiplech k zámkům Mini**

270,- Kč  
12,- EUR

materiál: magnetická nerez ocel  
povrch: NRz nerez broušeno **EUR**

270,- 12,-

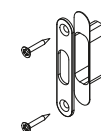

		TiN-K / TiN-K		ŠNi / nerez		Cr / nerez	
		cena / set	EAN	cena / set	EAN	cena / set	EAN
hranaté	Kč €	1940,- 81,-	108637	1290,- 54,-	109382	1640,- 69,-	110654
kulaté	Kč €	1940,- 81,-	110777	1290,- 54,-	110753	1640,- 69,-	110760

První uvedený povrch je povrch WC mechanismu, druhý za lomítkem je povrch čela zámku a protiplechu.

		TiN-K / TiN-K		ŠNi / nerez		Cr / nerez	
		cena / set	EAN	cena / set	EAN	cena / set	EAN
hranaté	Kč €	2260,- 95,-	112467	1710,- 72,-	112443	1980,- 83,-	112450
kulaté	Kč €	2110,- 88,-	112498	1550,- 65,-	112474	1840,- 77,-	112481

První uvedený povrch je povrch WC mechanismu, druhý za lomítkem je povrch čela zámku a protiplechu.

		ŠNi / nerez		Cr / nerez		TiN-K / TiN-K	
		cena / set	EAN	cena / set	EAN	cena / set	EAN
hranaté	Kč €	1270,- 53,-	112504	1400,- 59,-	112351	1830,- 77,-	112382
kulaté	Kč €	1140,- 48,-	112535	1260,- 53,-	112542	1530,- 64,-	112559
obdélníkové 33 x 47 mm	Kč €	1270,- 53,-	112566	1400,- 59,-	112573	1700,- 71,-	112580

První uvedený povrch je povrch WC mechanismu, druhý za lomítkem je povrch čela zámku a protiplechu.

**Poznámky:**

Čela zámků (WC, cylindrický) a protiplechu se dodávají standardně podle povrchů uvedených výše v tabulkách. Dále je možné dodat na základě požadavku bílé provedení čel zámků a protiplechu pro sjednocení bílého povrchu s provedením povrchu Magnetica a Magnetického bloku. Bílé provedení na zámcích je bez dalšího příplatku.

		NRz		Černá matná	
		cena / set	EAN	cena / set	EAN
	Kč €	270,- 12,-	141429	400,- 17,-	141436



Příbuzný sortiment

Kování pro hliníkové a ocelové dveře,  
kování na branky



Rozetové kování



Okenní kliky 225, 250 mm / HS Portaly  
na posuvná okna a stěny



Madla dlouhá

## Okenní kliky 3 a 4 polohové

Okenní kliky M&T doplňují kolekci dveřních klik vždy ve stejném designu a povrchové úpravě. Tím lze každý projekt, každou realizaci perfektně sladit v jeden celek. Vyberte si dveřní kliky z některé z designových řad a ve stejné designové řadě naleznete i okenní kliky odpovídajícího tvaru a barevného odstínu. Nabídka, kterou nenaleznete u žádné jiné firmy na trhu. Pro požadovanou funkčnost jsou ke kování připraveny 3 typy polohovacích mechanismů, kdy každý se vyznačuje svými přednostmi odpovídající materiálu a použití. Polohovací mechanismy jsou univerzální pro všechny typy okenních klik M&T, stačí jen zvolit požadovanou variantu podle specifických požadavků na funkčnost.

Materiál: **masivní mosaz** 

Povrchy: **SNi, SNI – broušeno, Cr, TiN-C, TiN-K, TiN-B, Ms, Ms-A, Ms-L, zakázkově TiN-S, TiN-A**  
více info na [www.kliky-mt.cz/manufaktura/barvy-povrchy](http://www.kliky-mt.cz/manufaktura/barvy-povrchy)

Materiál: **nerezová ocel**

Povrchy: **NRz, TiN-K, K-industrial**

**MINIMAL Cr** lesklý chrom

**ENTERO NRz** nerez -broušeno



uzamykatelný polohovací mechanismus

Kovový uzamykatelný mechanismus s vnitřní ocelovou konstrukcí a mosazným krytem. Univerzální mechanismus pro všechny typy okenních klik M&T. Dodáváme ve více povrchových úpravách viz. str. 267. Mechanismus je 3-polohový tzn. polohy po 90°, opatřen vyjímatelným klíčem. Standardní délka čtyřhranu 7x7 do rámu okna je 42 mm. Montáž identická jako u ostatních okenních mechanismů M&T.

polohovací mechanismus plastový

Plastový mechanismus s vnitřní plastovou konstrukcí, zaručující velmi tichý chod i po dlouhodobém používání, nevýhodou je vakl mezi okenní klikou a mechanismem způsobený vlastností plastu (pružnost).

polohovací mechanismus kovový

Kovový mechanismus s vnitřní celokovovou konstrukcí, zaručující přesnou polohovatelnost a pevnou fixaci okenní kliky v mechanismu, nevýhodou je hlučnější chod při dlouhodobém používání (nutnost pravidelné údržby).

Doporučujeme objednávat kovový.

konstrukční varianty, materiálové provedení

- polohovací mechanismus standardně se čtyřhranem 7x7 mm do rámu okna dodáváme v délce 37 mm
- další délky čtyřhranu 7x7 mm: 32, 42, 50 a 61 mm (požadovaný rozměr je třeba uvádět do objednávky)
- krycí rozety k polohovacímu mechanismu jsou v různých tvarových provedeních podle zvolené designové řady okenní kliky
- polohovací mechanismy jsou univerzální tj. 3 i 4 polohové, tzn. polohy po 90° nebo 45°
- polohovací mechanismy jsou plastové nebo kovové se specifikací výše
- záruka 3 roky, NRz 5 let, titany 15 let

roky **3 garance** let **5 garance** let **15 garance**



kovový mechanismus 37 mm  
EAN 119770 cena 160,- Kč / 6,7 EUR

kovový mechanismus 42 mm  
EAN 119787 cena 160,- Kč / 6,7 EUR

kovový mechanismus 50 mm  
EAN 119794 cena 170,- Kč / 7,1 EUR

kovový mechanismus 61 mm  
EAN 119800 cena 200,- Kč / 8,4 EUR

**Okenní kliky Nerez**

materiál: nerezová ocel  
povrch: NRz nerez - broušeno



Lusy



Deny



Meclis



Morgan



Jameson



Senza

NRz nerez - broušeno



Nova



Promo



Entero



Kvadra



Techno

TiN-K titan černý mat



Morgan



NRz nerez - broušeno



Lusy



Cesan

**Okenní kliky DESIGN 2012 ploché rozety**

materiál: nerezová ocel  
povrch: NRz nerez - broušeno



		NRz		TiN-K		K-industrial	
		cena / ks	EAN	cena / ks	EAN	cena / ks	EAN
Lusy	Kč €	390,- 17,-	80232	1010,- 43,-	023978	1010,- 43,-	033847
Deny	Kč €	390,- 17,-	80249	1010,- 43,-	023985	1010,- 43,-	033854
Meclis	Kč €	480,- 20,-	023893	1110,- 47,-	023992	1110,- 47,-	033861
Morgan	Kč €	480,- 20,-	80225	1110,- 47,-	024005	1110,- 47,-	033878
Jameson	Kč €	580,- 25,-	023909	1180,- 50,-	024012	1180,- 50,-	033885
Senza	Kč €	770,- 33,-	023923			1380,- 58,-	033892
Nova	Kč €	770,- 33,-	023916	1380,- 58,-	024029	1380,- 58,-	033908
Promo	Kč €	850,- 36,-	023930			1480,- 62,-	033915
Entero	Kč €	850,- 36,-	80218	1480,- 62,-	024050	1480,- 62,-	033922
Kvadra	Kč €	850,- 36,-	023947	1480,- 62,-	024067	1480,- 62,-	033939
Techno	Kč €	770,- 33,-	023954			1380,- 58,-	033946
Cesan	Kč €	660,- 28,-	023961	1290,- 54,-	024081	1290,- 54,-	033953
Sonia	Kč €	660,- 28,-	120813	1290,- 54,-	120820	1290,- 54,-	137767

Polohovací mechanismus není součástí okenní kliky a lze zvolit mechanismus plastový EAN 90309 ... 62 Kč/ks nebo kovový EAN 119770... 160 Kč/ks podle požadavku na funkčnost, viz. předchozí strana.

		NRz		TiN-K		K-industrial	
		cena / ks	EAN	cena / ks	EAN	cena / ks	EAN
Morgan							
oválná rozeta	Kč €	880,- 37,-	48638	1410,- 59,-	48645	1410,- 59,-	033984
obdélníková rozeta	Kč €	950,- 40,-	48423	1480,- 62,-	48430	1480,- 62,-	033991
Lusy							
oválná rozeta	Kč €	750,- 32,-	48614	1360,- 57,-	48621	1360,- 57,-	034004
obdélníková rozeta	Kč €	810,- 34,-	48263	1410,- 59,-	48287	1410,- 59,-	034011
Entero							
oválná rozeta	Kč €	880,- 37,-	48591	1520,- 64,-	48607	1520,- 64,-	033960
obdélníková rozeta	Kč €	950,- 40,-	48201	1570,- 66,-	48218	1570,- 66,-	033977
Cesan							
oválná rozeta	Kč €	810,- 34,-	48461	1410,- 59,-	48478	1410,- 59,-	034028

Polohovací mechanismus s plochou rozetou je 3-polohový kovový a je součástí příslušenství okenní kliky.

\* Povrch TiN-K je s rukojetí Entero, nelze dodat s rukojetí Entero II.

**Okenní kliky DESIGN 2000, 2004**

materiál: masivní mosaz  
povrch: SNI matný nikl



Lara

Ms mosaz natural



Cherez

Ms-L mosaz leštěno



Fábi



uzamykatelný mechanismus



Garanti



Andy



Cesan

Cr lesklý chrom



Lusy

TiN-C titan chrom mat



Entero

TiN-K titan černý mat

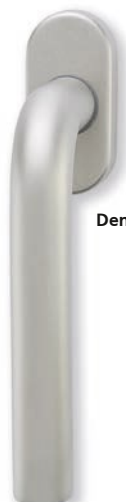

Deny



Maty



Meclis



Sogut

SNI matný nikl



Mondeo



Burak



Mia



Kemer



		SNI		Cr		Ms		Ms-L		TiN-C		TiN-K	
		cena / ks	EAN	cena / ks	EAN	cena / ks	EAN	cena / ks	EAN	cena / ks	EAN	cena / ks	EAN
uzamykatelný mechanismus	Kč €	1960,- 82,-	080704	2100,- 88,-	080728	2100,- 88,-	080735	2100,- 88,-	080742	2550,- 107,-	080759	2550,- 107,-	080766
Lara	Kč €	1820,- 76,-	70592	1970,- 83,-	70615	1970,- 83,-	059014	1970,- 83,-	059229	2460,- 103,-	70653	2460,- 103,-	70677
Cherez	Kč €	1640,- 69,-	70714	1820,- 76,-	70738	1820,- 76,-	059021	1820,- 76,-	059236	2310,- 97,-	70776	2310,- 97,-	70790
Fäbi	Kč €	1320,- 55,-	36741	1480,- 62,-	36758	1480,- 62,-	059038	1480,- 62,-	059243	1970,- 83,-	36772	1970,- 83,-	36789
Garanti	Kč €	980,- 41,-	36208	1150,- 48,-	36215	1150,- 48,-	059045	1150,- 48,-	059250	1640,- 69,-	36239	1640,- 69,-	36246
Andy	Kč €	1150,- 48,-	36567	1320,- 55,-	36574	1320,- 55,-	059052	1320,- 55,-	059267	1820,- 76,-	36598	1820,- 76,-	36604
Cesan	Kč €	980,- 41,-	36260	1150,- 48,-	36277	1150,- 48,-	059069	1150,- 48,-	059274	1640,- 69,-	36291	1640,- 69,-	36307
Lusy	Kč €	1150,- 48,-	36987	1320,- 55,-	36994	1320,- 55,-	059076	1320,- 55,-	059281	1820,- 76,-	37014	1820,- 76,-	37021
Entero	Kč €	1970,- 83,-	70479	2140,- 90,-	70493	2140,- 90,-	059083	2140,- 90,-	059298	2630,- 110,-	70530	2630,- 110,-	70554
Deny	Kč €	1150,- 48,-	37045	1320,- 55,-	37052	1320,- 55,-	059090	1320,- 55,-	059304	1820,- 76,-	37076	1820,- 76,-	37083
Maty	Kč €	1480,- 62,-	37106	1640,- 69,-	37113	1640,- 69,-	059106	1640,- 69,-	059311	2140,- 90,-	37137	2140,- 90,-	37144
Meclis	Kč €	1150,- 48,-	36925	1320,- 55,-	36932	1320,- 55,-	059113	1320,- 55,-	059328	1820,- 76,-	36956	1820,- 76,-	36963
Sogut	Kč €	1320,- 55,-	36628	1480,- 62,-	36635	1480,- 62,-	059120	1480,- 62,-	059335	1970,- 83,-	36659	1970,- 83,-	36666
L	Kč €	1320,- 55,-	36680	1480,- 62,-	36697	1480,- 62,-	059137	1480,- 62,-	059342	1970,- 83,-	36710	1970,- 83,-	36727
Mondeo	Kč €	1480,- 62,-	37168	1640,- 69,-	37175	1640,- 69,-	059144	1640,- 69,-	059359	2140,- 90,-	37199	2140,- 90,-	37205
L	Kč €	1480,- 62,-	37229	1640,- 69,-	37236	1640,- 69,-	059151	1640,- 69,-	059366	2140,- 90,-	37250	2140,- 90,-	37267
Burak	Kč €	1150,- 48,-	36321	1320,- 55,-	36338	1320,- 55,-	059168	1320,- 55,-	059373	1820,- 76,-	36352	1820,- 76,-	36369
L	Kč €	1150,- 48,-	36383	1320,- 55,-	36390	1320,- 55,-	059175	1320,- 55,-	059380	1820,- 76,-	36413	1820,- 76,-	36420
Mia	Kč €	1150,- 48,-	36802	1320,- 55,-	36819	1320,- 55,-	059182	1320,- 55,-	059397	1820,- 76,-	36833	1820,- 76,-	36840
L	Kč €	1150,- 48,-	36864	1320,- 55,-	36871	1320,- 55,-	059199	1320,- 55,-	059403	1820,- 76,-	36895	1820,- 76,-	36901
Kemer	Kč €	1320,- 55,-	36444	1480,- 62,-	36451	1480,- 62,-	059205	1480,- 62,-	059410	1970,- 83,-	36475	1970,- 83,-	36482
L	Kč €	1320,- 55,-	36505	1480,- 62,-	36512	1480,- 62,-	059212	1480,- 62,-	059427	1970,- 83,-	36536	1970,- 83,-	36543



Entry

SNi matný nikl - broušeno



Trinity

TiN-C titan chrom mat



My



Terry



Tukan

SNi matný nikl - broušeno



Maya



Toro



Mimolimit

TiN-B titan braun mat



Mini-V

SNi matný nikl



Mini-C



Mini-S



Mini-T

TiN-K titan černý mat



Minimal



Maximal

SNi matný nikl  
výplň dřevo - dýha teak



Minimal  
zapuštěná



Maximal  
zapuštěná

### Okenní kliky DESIGN 2006

materiál: masivní mosaz  
Kč povrch: SNi matný nikl - broušeno EUR

2470,-	103,-
2160,-	90,-
2320,-	97,-
2320,-	97,-

### Okenní kliky DESIGN 2009

materiál: masivní mosaz  
Kč povrch: SNi matný nikl - broušeno EUR

2500,-	105,-
2650,-	111,-
2500,-	105,-
2500,-	105,-

### Okenní kliky DESIGN 2011

materiál: masivní mosaz  
Kč povrch: SNi matný nikl EUR

1330,-	56,-
1330,-	56,-
1330,-	56,-
1330,-	56,-

### Okenní kliky Minimal / Maximal

materiál: masivní mosaz  
Kč povrch: SNi matný nikl EUR

2730,-	114,-
2960,-	124,-
3060,-	128,-
3300,-	138,-

u zapuštěné okenní kliky Minimal, Maximal je polohovací mechanismus 3-polohový a je přímo součástí kliky



		SNI - broušeno		Cr		Ms		Ms-L		TiN-C		TiN-K	
		cena / ks	EAN	cena / ks	EAN	cena / ks	EAN	cena / ks	EAN	cena / ks	EAN	cena / ks	EAN
Entry	Kč €	2470,- 103,-	77881	2640,- 110,-	77904	2640,- 110,-	059434	2640,- 110,-	059472	3140,- 131,-	77942	3140,- 131,-	77966
Trinity	Kč €	2160,- 90,-	78000	2320,- 97,-	78024	2320,- 97,-	059441	2320,- 97,-	059489	2810,- 118,-	78062	2810,- 118,-	78086
My	Kč €	2320,- 97,-	78123	2470,- 103,-	78147	2470,- 103,-	059458	2470,- 103,-	059496	2960,- 124,-	78185	2960,- 124,-	78208
Terry	Kč €	2320,- 97,-	78246	2470,- 103,-	78260	2470,- 103,-	059465	2470,- 103,-	059502	2960,- 124,-	78307	2960,- 124,-	78321

		SNI - broušeno		Cr		Ms		TiN-C		TiN-K		TiN-B	
		cena / ks	EAN	cena / ks	EAN	cena / ks	EAN	cena / ks	EAN	cena / ks	EAN	cena / ks	EAN
Tukan	Kč €	2500,- 105,-	28012	2650,- 111,-	022063	2650,- 111,-	059519	3150,- 132,-	28029			3150,- 132,-	28036
Maya	Kč €	2650,- 111,-	28067	2820,- 118,-	022100	2820,- 118,-	059526	3320,- 139,-	28074			3320,- 139,-	28081
Toro	Kč €	2500,- 105,-	28098	2650,- 111,-	022148	2650,- 111,-	059533	3150,- 132,-	28104			3150,- 132,-	28197
Mimolimit	pravá levá Kč €	2500,- 105,-	28203 85718	2650,- 111,-	022186 022193	2650,- 111,-	059540 059557	3150,- 132,-	28210 85770	3150,- 132,-	28227 85831	3150,- 132,-	28234 85893



		SNI		Cr		Ms		Ms-L		TiN-K	
		cena / ks	EAN	cena / ks	EAN	cena / ks	EAN	cena / ks	EAN	cena / ks	EAN
Mini-V	Kč €	1330,- 56,-	86289	1580,- 66,-	86333	1580,- 66,-	059618	1580,- 66,-	059656	1980,- 83,-	86388
Mini-C	Kč €	1330,- 56,-	86432	1580,- 66,-	86487	1580,- 66,-	059625	1580,- 66,-	059663	1980,- 83,-	86531
Mini-S	Kč €	1330,- 56,-	86586	1580,- 66,-	86630	1580,- 66,-	059632	1580,- 66,-	059670	1980,- 83,-	86685
Mini-T	Kč €	1330,- 56,-	86739	1580,- 66,-	86784	1580,- 66,-	059649	1580,- 66,-	059687	1980,- 83,-	86838

Polohovací mechanismus není součástí okenní kliky a lze zvolit mechanismus kovový EAN 119770... 160 Kč/ks podle požadavku na funkčnost, viz. strana 263.

		SNI		SNI - broušeno		Cr		Ms		TiN-C		TiN-B		TiN-K	
		cena / ks	EAN	cena / ks	EAN	cena / ks	EAN	cena / ks	EAN	cena / ks	EAN	cena / ks	EAN	cena / ks	EAN
Minimal	Kč €	2730,- 114,-	001815	2800,- 117,-	001822	2910,- 122,-	001839	2910,- 122,-	059694	3400,- 142,-	001846	3400,- 142,-	001853	3400,- 142,-	001860
Minimal zapuštěná	Kč €	2960,- 124,-	071085	3040,- 127,-	071092	3140,- 131,-	071108	3140,- 131,-	071115	3630,- 152,-	071139	3630,- 152,-	071153	3630,- 152,-	071146
Maximal	Kč €	3060,- 128,-	001884	3130,- 131,-	001891	3220,- 135,-	001907	2810,- 118,-	059700	3710,- 155,-	001914	3710,- 155,-	001921	3710,- 155,-	001938
Maximal zapuštěná	Kč €	3300,- 138,-	071177	3390,- 142,-	071184	3460,- 145,-	071191	3460,- 145,-	071207	3950,- 165,-	071221	3950,- 165,-	071245	3950,- 165,-	071238

specifikace výplně kliky Maximal, cena, EAN na str. 105, „výplň kliky Maximal“



## Příbuzný sortiment

Rozetové kování



Kování pro hliníkové a ocelové dveře,  
kování na branky



Mušle na posuvné  
dveře



Okenní kliky  
3 a 4 polohové



Magnetické zámky



Madla dlouhá



## Okenní kliky 225, 250 mm / HS Portaly na posuvná okna a stěny

Materiál: nerez ocel, masivní mosaz   
Povrchy: SNI, Cr, SNI-broušeno, TiN-C, TiN-B, TiN-K, Ms, Ms-L, zakázkově TiN-A, NRZ, K-industrial  
více info na [www.kliky-mt.cz/manufaktura/barvy-povrchy](http://www.kliky-mt.cz/manufaktura/barvy-povrchy)

Kování M&T v systému HS Portal je reakcí na požadavky zákazníku vyžadujících tu nejvyšší kvalitu a mimořádný design na ovládacích klikách u velkoplošných oken a prosklených stěn, které patří k dominantám projektů. Aby tomu tak bylo, jsou připraveny splnit designové řady Minimal / Maximal a Mimolimit ve všech variantách povrchových úprav včetně titanových povrchů i ty nejnáročnější požadavky architektů a investorů dokonalých staveb.

### MINIMAL

TiN-K titan černý mat



### MIMOLIMIT

SNI matný nikl + masivní ořech



### ENTERO

TiN-K titan černý mat



### LUSY

NRZ nerez-broušeno

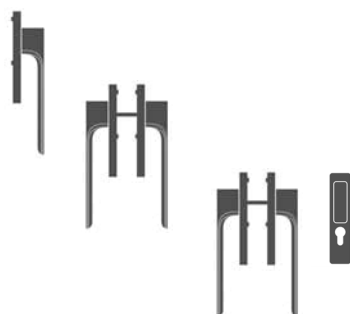

Klika jednostranná

Klika oboustranná

Klika oboustranná s cylindrickým otvorem



Mušle venkovní

Mušle venkovní s cylindrickým otvorem

#### konstrukční varianty, materiálové provedení

- konstrukčně a montážně připraveno pro systém HS Portal
- montáž na tl. rámu 55 – 120 mm, montážní materiál je třeba specifikovat podle tloušťky rámu
- rukojeť vyrobena z masivní mosazi
- délka rukojeti Minimal, Lusy 225 mm
- délka rukojeti Mimolimit, Entero 250 mm
- krycí štít vyroben z masivní mosazi
- vysokopevnostní ovládací trn/čtyřhran z nerez oceli 10x10 mm
- záruka 3 roky, titány 15 let

roky **3** garance | let **15** garance

#### Ochranné známky – registrované značky

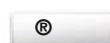

**MINIMAL**®  
**MAXIMAL**®  
**MIMOLIMIT**®

#### Chráněné průmyslové vzory klik



**MINIMAL**  
**MIMOLIMIT**



TiN-C titan chrom mat



SNI matný nikl



TiN-K titan černý mat



Ms mosaz natural

**Klika 225 mm Minimal**  
k dveřním systémům HS portal

7050,- Kč  
294,- EUR

materiál: masivní mosaz  
povrch: SNI matný nikl

Kč	EUR
7050,-	294,-
7130,-	298,-
14070,-	587,-
14210,-	593,-



MAXIMAL SNI matný nikl  
výplň dřevo teak

**Klika 225 mm Maximal**  
k dveřním systémům HS portal

7370,- Kč  
308,- EUR

materiál: masivní mosaz  
povrch: SNI matný nikl

Kč	EUR
7370,-	308,-
7410,-	309,-
14700,-	613,-
14810,-	618,-

**Výplň kliky 225 mm**  
Maximal

630,- Kč  
27,- EUR







	SNI		SNI - broušeno		Cr		Ms		TiN-C		TiN-B		TiN-K		
	cena	EAN	cena	EAN	cena	EAN	cena	EAN	cena	EAN	cena	EAN	cena	EAN	
jednostranná*	Kč €	ks 7050,- 294,-	001990	ks 7290,- 304,-	002003	ks 7470,- 312,-	002010	ks 7470,- 312,-	059731	ks 8700,- 363,-	002027	ks 8700,- 363,-	002034	ks 8700,- 363,-	002041
jednostranná s cylindr. otvorem*	Kč €	ks 7130,- 298,-	064698	ks 7360,- 307,-	064704	ks 7520,- 314,-	064711	ks 7520,- 314,-	064766	ks 8790,- 367,-	064728	ks 8790,- 367,-	064735	ks 8790,- 367,-	064742
oboustranná	Kč €	pár 14070,- 587,-	002065	pár 14540,- 606,-	002072	pár 14900,- 621,-	002089	pár 14900,- 621,-	059748	pár 17380,- 725,-	002096	pár 17380,- 725,-	002102	pár 17380,- 725,-	002119
oboustranná s cylindr. otvorem	Kč €	pár 14210,- 593,-	002133	pár 14660,- 611,-	002140	pár 15030,- 627,-	002157	pár 15030,- 627,-	059755	pár 17490,- 729,-	002164	pár 17490,- 729,-	002171	pár 17490,- 729,-	002188

\* Nutno upřesnit přesnou délku montážních šroubů a čtyřhranu.



	SNI		SNI - broušeno		Cr		Ms		TiN-C		TiN-B		TiN-K		
	cena	EAN	cena	EAN	cena	EAN	cena	EAN	cena	EAN	cena	EAN	cena	EAN	
jednostranná*	Kč €	ks 7370,- 308,-	002270	ks 7590,- 317,-	002287	ks 7800,- 325,-	002294	ks 7800,- 325,-	059793	ks 9030,- 377,-	002300	ks 9030,- 377,-	002317	ks 9030,- 377,-	002324
jednostranná s cylindr. otvorem*	Kč €	ks 7410,- 309,-	064780	ks 7660,- 320,-	064797	ks 7850,- 328,-	064803	ks 7850,- 328,-	064858	ks 9070,- 378,-	064810	ks 9070,- 378,-	064827	ks 9070,- 378,-	064834
oboustranná	Kč €	pár 14700,- 613,-	002348	pár 15140,- 631,-	002355	pár 15510,- 647,-	002362	pár 15510,- 647,-	059809	pár 17990,- 750,-	002379	pár 17990,- 750,-	002386	pár 17990,- 750,-	002393
oboustranná s cylindr. otvorem	Kč €	pár 14810,- 618,-	002416	pár 15280,- 637,-	002423	pár 15630,- 652,-	002430	pár 15630,- 652,-	059816	pár 18100,- 755,-	002447	pár 18100,- 755,-	002454	pár 18100,- 755,-	002461

	cena	EAN
	ks	
dřevo	Kč € 630,- 27,-	002485
kov	Kč € 630,- 27,-	002492
kůže	Kč € 750,- 32,-	002508
„sklo“	Kč € 750,- 32,-	002515
RAL barvy	Kč € 780,- 33,-	022513

\* Nutno upřesnit přesnou délku montážních šroubů a čtyřhranu.



**SNi** matný nikl + masivní ořech



**TiN-K** titan černý mat + mořený dub

**Klika 250 mm Mimolimit**  
k dveřním systémům HS portal

5380,- Kč  
225,- EUR

**Dřevěná část rukojeti**  
250 mm

1370,- Kč  
58,- EUR

materiál: masivní mosaz  
Kč povrch: SNi matný nikl - broušeno EUR

5380,-	225,-
5430,-	227,-
10710,-	447,-
10850,-	453,-



**TiN-C** titan chrom mat



**TiN-K** titan černý mat



**SNi** matný nikl

**Mušle Minimal venkovní**  
k dveřním systémům HS portal

2970,- Kč  
124,- EUR



**Ms** mosaz natural

materiál: masivní mosaz  
Kč povrch: SNi matný nikl EUR

2970,-	124,-
3060,-	128,-



		Sni - broušeno		Cr		Ms		Ms-L		TiN-C		TiN-B		TiN-K	
		cena	EAN	cena	EAN	cena	EAN	cena	EAN	cena	EAN	cena	EAN	cena	EAN
jednostranná	Kč €	ks 5380,- 225,-	026108	ks 5740,- 240,-	026115	ks 5740,- 240,-	059854	ks 5740,- 240,-	059885	ks 6590,- 275,-	026122	ks 6920,- 289,-	026139	ks 6920,- 289,-	026146
jednostranná s cylindrickým otvorem	Kč €	ks 5430,- 227,-	064872	ks 5820,- 243,-	064889	ks 5820,- 243,-	064926	ks 5820,- 243,-	064933	ks 6660,- 278,-	064896	ks 6980,- 291,-	064902	ks 6980,- 291,-	064919
oboustranná	Kč €	pár 10710,- 447,-	026153	pár 11460,- 478,-	026160	pár 11460,- 478,-	059861	pár 11460,- 478,-	059892	pár 13140,- 548,-	026177	pár 13810,- 576,-	026184	pár 13810,- 576,-	026191
oboustranná s cylindrickým otvorem	Kč €	pár 10850,- 453,-	028478	pár 11610,- 484,-	028485	pár 11610,- 484,-	059878	pár 11610,- 484,-	059908	pár 13290,- 554,-	028492	pár 13930,- 581,-	028508	pár 13930,- 581,-	028515

		Teak		Jilm		Ořech		Dub		Bělený dub	
		cena / ks	EAN	cena / ks	EAN	cena / ks	EAN	cena / ks	EAN	cena / ks	EAN
	Kč €	1370,- 58,-	026207	1260,- 53,-	026214	1260,- 53,-	026221	1260,- 53,-	026238	1370,- 58,-	026245

Zakázkově lze rukojeť dodat v dalších dřevinách.



		Sni		Sni - broušeno		Cr		Ms		TiN-C		TiN-B		TiN-K	
		cena	EAN	cena	EAN	cena	EAN	cena	EAN	cena	EAN	cena	EAN	cena	EAN
mušle venkovní	Kč €	ks 2970,- 124,-	002201	ks 3110,- 130,-	002218	ks 3220,- 135,-	002225	ks 3220,- 135,-	059915	ks 3500,- 146,-	002232	ks 3500,- 146,-	002249	ks 3500,- 146,-	002256
mušle venk. s cylindr. otvorem	Kč €	ks 3060,- 128,-	022544	ks 3160,- 132,-	022551	ks 3300,- 138,-	022568	ks 3300,- 138,-	059922	ks 3620,- 151,-	022575	ks 3620,- 151,-	022582	ks 3620,- 151,-	022599

Vzhledem k technologickému omezení upozorňujeme na odlišný povrch a odlišný barevný odstín uvnitř v úchopné části mušle oproti ostatní pohledové ploše. Standardní provedení si odsouhlasíte podle referenčního vzorku.



NRz nerez - broušeno



TiN-K titan černá mat

**Klika 225 mm Lusy**  
k dveřním systémům HS portal

2960,- Kč  
124,- EUR

materiál: nerezová ocel  
Kč povrch: NRz nerez - broušeno EUR

2960,-		124,-
3040,-		127,-
5920,-		247,-
6040,-		252,-



**Klika 250 mm Entero**  
k dveřním systémům HS portal

4520,- Kč  
189,- EUR

materiál: nerezová ocel  
Kč povrch: NRz nerez - broušeno EUR

4520,-		189,-
4590,-		192,-
9030,-		377,-
9140,-		381,-



**Mušle venkovní**

1040,- Kč  
44,- EUR

materiál: nerezová ocel  
Kč povrch: NRz nerez - broušeno EUR

1040,-		44,-
1090,-		46,-

		NRz		TiN-K		K-industrial	
		cena	EAN	cena	EAN	cena	EAN
jednostranná*	Kč €	ks 2960,- 124,-	064216	ks 4370,- 183,-	064254	ks 4370,- 183,-	142792
jednostranná s cylindr. otvorem*	Kč €	ks 3040,- 127,-	064940	ks 4430,- 185,-	064957	ks 4430,- 185,-	142822
oboustranná	Kč €	pár 5920,- 247,-	064223	pár 8700,- 363,-	064261	pár 8700,- 363,-	142808
oboustranná s cylindr. otvorem	Kč €	pár 6040,- 252,-	064230	pár 8830,- 368,-	064278	pár 8830,- 368,-	142815

\* Při montáži bez venkovní mušle nutno upřesnit přesnou délku montážních šroubů a čtyřhranu.

		NRz		TiN-K		K-industrial	
		cena	EAN	cena	EAN	cena	EAN
jednostranná*	Kč €	ks 4520,- 189,-	064247	ks 5920,- 247,-	064285	ks 5920,- 247,-	144260
jednostranná s cylindr. otvorem*	Kč €	ks 4590,- 192,-	064964	ks 5980,- 250,-	064971	ks 5980,- 250,-	144291
oboustranná	Kč €	pár 9030,- 377,-	064292	pár 11810,- 493,-	064339	pár 11810,- 493,-	144277
oboustranná s cylindr. otvorem	Kč €	pár 9140,- 381,-	064308	pár 11930,- 498,-	064346	pár 11930,- 498,-	144284

\* Nutno upřesnit přesnou délku montážních šroubů a čtyřhranu.

		NRz		TiN-K		K-industrial	
		cena / ks	EAN	cena / ks	EAN	cena / ks	EAN
mušle venkovní	Kč €	1040,- 44,-	064315	1510,- 63,-	064353	1510,- 63,-	142839
mušle venk. s cylindr. otvorem	Kč €	1090,- 46,-	064322	1550,- 65,-	064360	1550,- 65,-	142846

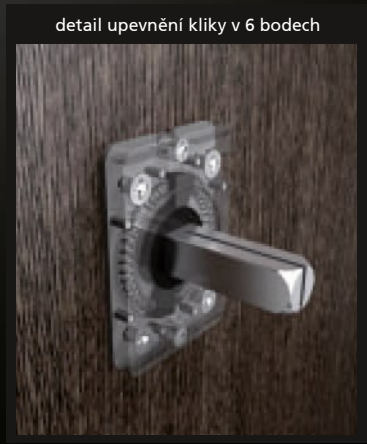

detail upevnění kliky v 6 bodech

Příbuzný sortiment

Madla a koule na skleněné a dřevěné dveře



Bezpečnostní rozety



Okenní kliky 3 a 4 polohové



Bezpečnostní madla Entero



Madla dlouhá



## Kování pro hliníkové a ocelové dveře, kování na branky

Kování M&T pro hliníkové a ocelové dveře splňuje ty nejnáročnější požadavky na konstrukci a funkčnost na namáhaných dveřích tohoto typu. Nová konstrukce vnitřních rozet se systémem tlačných pružin s nerezovým jádrem perfektně fixuje funkční čtyřhran mezi zámkem a kovááním a tím nedochází k hýbání a svěšování klik. Rozety jsou navíc opatřeny dvojicí zajišťovacích červíků, které pevně fixují celé kování k vnitřní konstrukci. Tento konstrukční systém je zároveň vhodný pro branky a všechny vstupní prostory, kde je požadavek na montáž do uzších profilů bez možnosti prošroubování skrze dveřní zámek. Samozřejmostí je montáž také na dřevěné dveře. Zde doporučujeme povrch NRz, TiN-C a TiN-K.

Materiál: **masivní mosaz** 

Povrchy: **SNi, SNi – broušeno, Cr, TiN-C, TiN-K, TiN-B, Ms, Ms-L, Cr-K, zakázkově TiN-A**  
vice info na [www.kliky-mt.cz/manufaktura/barvy-povrchy](http://www.kliky-mt.cz/manufaktura/barvy-povrchy)

Materiál: **nerezová ocel**

Povrchy: **NRz, TiN-K, K-industrial**

### MINIMAL **Cr** lesklý chrom



konstrukční varianty, materiálové provedení

- dokonalá montáž pro všechny typy Al a ocelových dveří
- rozety s minimálním rozměrem 33x47 mm, tl. 12 mm
- doporučený výstup cylindrické vložky ze dveří 12 mm
- varianta rozety i s ochrannou překrytkou
- u varianty s ochrannou překrytkou max. výstup 8 mm
- konstrukční systém 4 tlačných pružin u kliky
- nerezové jádro vnitřní konstrukce
- montáž pomocí až 12-ti samořezných vrtů
- další fixace rozety pomocí červíků M4
- rukojeti a rozety vyrobeny z masivní mosazi
- zajišťovací gel proti uvolnění šroubů
- vrtání PROFI šablonou M&T
- montáž pro tloušťky dveří 38 – 126 mm
- záruka 3 roky, titany 15 let

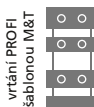

roky **3 garance** let **15 garance**

Ochranné známky – registrované značky

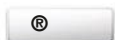

**MINIMAL**®  
**ENTERO**®

Chráněné průmyslové vzory klik **ENTERO**  
**MINIMAL**  
**MIMOLIMIT**  
**ENTRY**  
**TERRY**  
**TRINITY**  
**MY**  
**TORO**  
**TUKAN**  
**MAYA**

Patent **patent**

konstrukce ovládání kliky se systémem tlačných pružin, s velmi tichým chodem a trojitou stabilizací kliky

### ENTERO **NRz** nerez -broušeno



- dokonalá montáž pro všechny typy Al a ocelových dveří
- rozety s minimálním rozměrem 33x49 mm, tl. 12 mm
- doporučený výstup cylindrické vložky ze dveří 12 mm
- varianta rozety i s ochrannou překrytkou
- u varianty s ochrannou překrytkou max. výstup 8 mm
- konstrukční systém 4 tlačných pružin u kliky
- nerezové jádro vnitřní konstrukce
- montáž pomocí až 12-ti samořezných vrtů
- další fixace rozety pomocí červíků M4
- rukojeti a rozety vyrobeny z nerez oceli
- u protipožární varianty spojovací prvky a čtyřhran z nerez oceli
- zajišťovací gel proti uvolnění šroubů
- vrtání PROFI šablonou M&T
- montáž pro tloušťky dveří 38 – 126 mm
- záruka 5 let, titany 15 let

let **5 garance** let **15 garance**

Zatřídění kování podle normy EN 1906:2012, ČSN EN 1906 16 5776  
Prohlášení o shodě na [www.kliky-mt.cz/certifikaty](http://www.kliky-mt.cz/certifikaty)

Objekt **36-0031B**

Projekt tř. 4 **47-D1141B**

popisy číselného značení na str. 29 Dveřní kliky NEREZ



SNi matný nikel



TiN-K titan černý mat



Cr lesklý chrom

**Trinity**

3700,- Kč  
155,- EUR

**Entry**

4190,- Kč  
175,- EUR

**Entero**

4190,- Kč  
175,- EUR

**Terry**

3860,- Kč  
161,- EUR

**My**

3860,- Kč  
161,- EUR

**Minimal**

4870,- Kč  
203,- EUR

**KČ** materiál: masivní mosaz povrch: SNi matný nikel **EUR**

3700,-  155,-

4850,-   203,-

4850,-   203,-

4190,-  175,-

5350,-   223,-

5350,-   223,-

4190,-  175,-

5350,-   223,-

5350,-   223,-

3860,-  161,-

5030,-   210,-

5030,-   210,-

3860,-  161,-

5030,-   210,-

5030,-   210,-

**KČ** materiál: masivní mosaz povrch: SNi matný nikel **EUR**

4870,-  203,-

5530,-   231,-

5530,-   231,-





		SNI		SNI - broušeno		Cr		Ms		TiN-C		TiN-K	
		cena / pár	EAN	cena / pár	EAN	cena / pár	EAN	cena / pár	EAN	cena / pár	EAN	cena / pár	EAN
klika / klika	Kč €	3700,- 155,-	037401	3810,- 159,-	35263	3950,- 165,-	35294	3950,- 165,-	059953	5100,- 213,-	35355	5100,- 213,-	35386
madlo / klika R	Kč €	4850,- 203,-	037418	4930,- 206,-	35270	5100,- 213,-	35300	5100,- 213,-	059960	6270,- 262,-	35362	6270,- 262,-	35393
madlo / klika L	Kč €	4850,- 203,-	037425	4930,- 206,-	35287	5100,- 213,-	35317	5100,- 213,-	059977	6270,- 262,-	35379	6270,- 262,-	35409
klika / klika	Kč €	4190,- 175,-	037432	4300,- 180,-	35416	4440,- 185,-	35447	4440,- 185,-	060010	5600,- 234,-	35508	5600,- 234,-	35539
madlo / klika R	Kč €	5350,- 223,-	037449	5430,- 227,-	35423	5600,- 234,-	35454	5600,- 234,-	060027	6920,- 289,-	35515	6920,- 289,-	35546
madlo / klika L	Kč €	5350,- 223,-	037456	5430,- 227,-	35430	5600,- 234,-	35461	5600,- 234,-	060034	6920,- 289,-	35522	6920,- 289,-	35553
klika / klika	Kč €	4190,- 175,-	037463	4300,- 180,-	42957	4440,- 185,-	42988	4440,- 185,-	060072	5600,- 234,-	43169	5600,- 234,-	43190
madlo / klika R	Kč €	5350,- 223,-	037470	5430,- 227,-	42964	5600,- 234,-	42995	5600,- 234,-	060089	6920,- 289,-	43176	6920,- 289,-	43206
madlo / klika L	Kč €	5350,- 223,-	037487	5430,- 227,-	42971	5600,- 234,-	43121	5600,- 234,-	060096	6920,- 289,-	43183	6920,- 289,-	43213
klika / klika	Kč €	3860,- 161,-	037494	3950,- 165,-	35560	4130,- 173,-	35591	4130,- 173,-	060133	5280,- 220,-	42872	5280,- 220,-	42926
madlo / klika R	Kč €	5030,- 210,-	037500	5100,- 213,-	35577	5280,- 220,-	35607	5280,- 220,-	060140	6420,- 268,-	42902	6420,- 268,-	42933
madlo / klika L	Kč €	5030,- 210,-	037517	5100,- 213,-	35584	5280,- 220,-	42834	5280,- 220,-	060157	6420,- 268,-	42919	6420,- 268,-	42940
klika / klika	Kč €	3860,- 161,-	037524	3950,- 165,-	43220	4130,- 173,-	64911	4130,- 173,-	060195	5280,- 220,-	64973	5280,- 220,-	65000
madlo / klika R	Kč €	5030,- 210,-	037531	5100,- 213,-	43237	5280,- 220,-	64928	5280,- 220,-	060201	6420,- 268,-	64980	6420,- 268,-	65017
madlo / klika L	Kč €	5030,- 210,-	037548	5100,- 213,-	64904	5280,- 220,-	64935	5280,- 220,-	060218	6420,- 268,-	64997	6420,- 268,-	65024



		SNI		SNI - broušeno		Cr		Ms		TiN-C		TiN-B		TiN-K	
		cena	EAN	cena	EAN	cena	EAN	cena	EAN	cena	EAN	cena	EAN	cena	EAN
klika / klika	Kč €	4870,- 203,-	003062	4940,- 206,-	003079	5170,- 216,-	003086	5170,- 216,-	060256	6350,- 265,-	003093	6350,- 265,-	003109	6350,- 265,-	003116
madlo / klika R	Kč €	5530,- 231,-	003130	5610,- 234,-	003147	5820,- 243,-	003154	5820,- 243,-	060263	7010,- 293,-	003161	7010,- 293,-	003178	7010,- 293,-	003185
madlo / klika L	Kč €	5530,- 231,-	003208	5610,- 234,-	003215	5820,- 243,-	003222	5820,- 243,-	060270	7010,- 293,-	003239	7010,- 293,-	003246	7010,- 293,-	003253

U kombinace madlo / klika dodáváme standardně madlo Minimal pevné - neotočné. Na základě požadavku madlo Entero pevné - neotočné. Lze dodat madlo Entero otočné s funkcí kliky. V balení je standardně montážní materiál pro tl. dveří 38 - 45 mm. Nad 45 mm je třeba uvádět přesnou tl. dveří. Cena montážního materiálu pro jiné tl. dveří je zahrnuta v ceně kování.

Vhodnost jednotlivých designů - tvarů klik pro konkrétní zakázku musí ověřit výrobce dveří podle rozměru Dornmas zvoleného zámku. Pro zámek s rozměrem Dornmas 40 mm a vyšším lze použít všechny kliky z nabídky M&T pro hliníkové a ocelové dveře.



SNi matný nikl

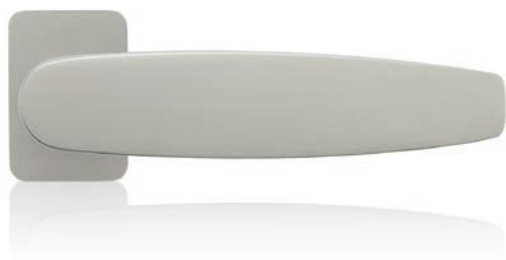

**Lusy**

2600,- Kč  
109,- EUR

**Garanti**

2540,- Kč  
106,- EUR

**Sogut**

2890,- Kč  
121,- EUR

**Cesan**

2470,- Kč  
103,- EUR

**Cherez**

3390,- Kč  
142,- EUR

Kč materiál: masivní mosaz povrch: SNi matný nikl EUR

2600,- 109,-

3460,- 145,-

3460,- 145,-

2540,- 106,-

3400,- 142,-

3400,- 142,-

2890,- 121,-

3750,- 157,-

3750,- 157,-

2470,- 103,-

3350,- 140,-

3350,- 140,-

3390,- 142,-

4540,- 190,-

4540,- 190,-



		SNI		Cr		Ms		Cr-K		TiN-C		TiN-K	
		cena pár	EAN	cena pár	EAN	cena pár	EAN	cena pár	EAN	cena pár	EAN	cena pár	EAN
klika / klika	Kč €	2600,- 109,-	024173	2930,- 123,-	024203	2930,- 123,-	060317	3620,- 151,-	066531	3920,- 164,-	024234	3920,- 164,-	024265
madlo / klika R	Kč €	3460,- 145,-	024180	3810,- 159,-	024210	3810,- 159,-	060324	4850,- 203,-	066548	4930,- 206,-	024241	4930,- 206,-	024272
madlo / klika L	Kč €	3460,- 145,-	024197	3810,- 159,-	024227	3810,- 159,-	060331	4850,- 203,-	066555	4930,- 206,-	024258	4930,- 206,-	024289
klika / klika	Kč €	2540,- 106,-	024326	2870,- 120,-	024357	2870,- 120,-	060379	3530,- 148,-	066562	3850,- 161,-	024388	3850,- 161,-	024418
madlo / klika R	Kč €	3400,- 142,-	024333	3710,- 155,-	024364	3710,- 155,-	060386	5200,- 217,-	066579	4870,- 203,-	024395	4870,- 203,-	024425
madlo / klika L	Kč €	3400,- 142,-	024340	3710,- 155,-	024371	3710,- 155,-	060393	5200,- 217,-	066586	4870,- 203,-	024401	4870,- 203,-	024432
klika / klika	Kč €	2890,- 121,-	024470	3210,- 134,-	024500	3210,- 134,-	060430	4030,- 168,-	066593	4190,- 175,-	024531	4190,- 175,-	024562
madlo / klika R	Kč €	3750,- 157,-	024487	4100,- 171,-	024517	4100,- 171,-	060447	5260,- 220,-	066609	5240,- 219,-	024548	5240,- 219,-	024579
madlo / klika L	Kč €	3750,- 157,-	024494	4100,- 171,-	024524	4100,- 171,-	060454	5260,- 220,-	066616	5240,- 219,-	024555	5240,- 219,-	024586
klika / klika	Kč €	2470,- 103,-	027181	2810,- 118,-	027211	2810,- 118,-	060492	3460,- 145,-	066623	3810,- 159,-	027242	3810,- 159,-	027273
madlo / klika R	Kč €	3350,- 140,-	027198	3660,- 153,-	027228	3660,- 153,-	060508	4650,- 194,-	066630	4830,- 202,-	027259	4830,- 202,-	027280
madlo / klika L	Kč €	3350,- 140,-	027204	3660,- 153,-	027235	3660,- 153,-	060515	4650,- 194,-	066647	4830,- 202,-	027266	4830,- 202,-	027297
klika / klika	Kč €	3390,- 142,-	027334	3700,- 155,-	027365	3700,- 155,-	060553	4700,- 196,-	066654	4690,- 196,-	027396	4690,- 196,-	027426
madlo / klika R	Kč €	4540,- 190,-	027341	4870,- 203,-	027372	4870,- 203,-	060560	6350,- 265,-	066661	6030,- 252,-	027402	6030,- 252,-	027433
madlo / klika L	Kč €	4540,- 190,-	027358	4870,- 203,-	027389	4870,- 203,-	060577	6350,- 265,-	066678	6030,- 252,-	027419	6030,- 252,-	027440

U kombinace madlo / klika dodáváme standardně madlo Entero pevné - neotočné. Na základě požadavku madlo Minimal pevné - neotočné. Lze dodat madlo Entero otočné s funkcí kliky. V balení je standardně montážní materiál pro tl. dveří 38 - 45 mm. Nad 45 mm je třeba uvádět přesnou tl. dveří. Cena montážního materiálu pro jiné tl. dveří je zahrnuta v ceně kování.

**Kování Mini pro hliníkové a ocelové dveře**



Ms mosaz natural



TiN-K titan černá mat



Cr lesklý chrom

**Mini-V**

2810,- Kč  
118,- EUR

Kč materiál: masivní mosaz  
povrch: SNI matný nikel EUR

2810,-  118,-

3810,-   159,-

3810,-   159,-

**Mini-C**

2640,- Kč  
110,- EUR

2640,-  110,-

3630,-   152,-

3630,-   152,-

**Mini-S**

2640,- Kč  
110,- EUR

2640,-  110,-

3630,-   152,-

3630,-   152,-

**Mini-T**

2640,- Kč  
110,- EUR

2640,-  110,-

3630,-   152,-

3630,-   152,-



		Sni		Cr		Ms		Ms-L		TiN-K	
		cena pár	EAN	cena pár	EAN	cena pár	EAN	cena pár	EAN	cena pár	EAN
klika / klika	Kč €	2810,- 118,-	064988	3140,- 131,-	065015	3140,- 131,-	065077	3140,- 131,-	065107	4130,- 173,-	065046
madlo / klika R	Kč €	3810,- 159,-	064995	4130,- 173,-	065022	4130,- 173,-	065084	4130,- 173,-	065114	5100,- 213,-	065053
madlo / klika L	Kč €	3810,- 159,-	065008	4130,- 173,-	065039	4130,- 173,-	065091	4130,- 173,-	065121	5100,- 213,-	065060
klika / klika	Kč €	2640,- 110,-	065954	2960,- 124,-	065985	2960,- 124,-	066043	2960,- 124,-	066074	3950,- 165,-	066012
madlo / klika R	Kč €	3630,- 152,-	065961	3950,- 165,-	065992	3950,- 165,-	066050	3950,- 165,-	066081	4930,- 206,-	066029
madlo / klika L	Kč €	3630,- 152,-	065978	3950,- 165,-	066005	3950,- 165,-	066067	3950,- 165,-	066098	4930,- 206,-	066036
klika / klika	Kč €	2640,- 110,-	066104	2960,- 124,-	066135	2960,- 124,-	066197	2960,- 124,-	066227	3950,- 165,-	066166
madlo / klika R	Kč €	3630,- 152,-	066111	3950,- 165,-	066142	3950,- 165,-	066203	3950,- 165,-	066234	4930,- 206,-	066173
madlo / klika L	Kč €	3630,- 152,-	066128	3950,- 165,-	066159	3950,- 165,-	066210	3950,- 165,-	066241	4930,- 206,-	066180
klika / klika	Kč €	2640,- 110,-	066258	2960,- 124,-	066289	2960,- 124,-	066340	2960,- 124,-	066371	3950,- 165,-	066319
madlo / klika R	Kč €	3630,- 152,-	066265	3950,- 165,-	066296	3950,- 165,-	066357	3950,- 165,-	066388	4930,- 206,-	066326
madlo / klika L	Kč €	3630,- 152,-	066272	3950,- 165,-	066302	3950,- 165,-	066364	3950,- 165,-	066395	4930,- 206,-	066333



SNi matný nikel + teak

**Mimolimit**

4620,- Kč  
193,- EUR



**Toro**

4620,- Kč  
193,- EUR



**Minimal  
madlo / madlo**  
pevné - neotočné

**Entero  
madlo / madlo**  
pevné - neotočné

SNi matný nikel



**Rozeta 33x47 mm**

840,- Kč  
35,- EUR



NRz nerez - broušeno

**Entero  
madlo / madlo**  
pevné - neotočné

**Rozety 33x49 mm**

940,- Kč  
40,- EUR



materiál: masivní mosaz  
Kč povrch: SNi matný nikel broušeno EUR

4620,- 193,-

5930,- 248,-

5930,- 248,-

4620,- 193,-

5930,- 248,-

5930,- 248,-

materiál: masivní mosaz  
Kč povrch: SNi matný nikel EUR

5460,- 228,-

5120,- 214,-

materiál: masivní mosaz  
Kč povrch: SNi matný nikel EUR

840,- 35,-

1330,- 56,-

990,- 42,-

materiál: nerezová ocel  
Kč povrch: NRz nerez - broušeno EUR

4830,- 202,-

materiál: nerezová ocel  
Kč povrch: NRz nerez - broušeno EUR

940,- 40,-

1400,- 59,-

1090,- 46,-



		Sni - broušeno		Cr		Ms		TiN-C		TiN-K		TiN-B	
		cena / pár	EAN	cena / pár	EAN	cena / pár	EAN	cena / pár	EAN	cena / pár	EAN	cena / pár	EAN
klika / klika	Kč €	4620,- 193,-	65031	4800,- 200,-	65062	4800,- 200,-	060614	5930,- 248,-	055399	5930,- 248,-	65093	5930,- 248,-	84339
madlo / klika R	Kč €	5930,- 248,-	65048	6090,- 254,-	65079	6090,- 254,-	060621	7400,- 309,-	055405	7400,- 309,-	65109	7400,- 309,-	84346
madlo / klika L	Kč €	5930,- 248,-	65055	6090,- 254,-	65086	6090,- 254,-	060638	7400,- 309,-	055412	7400,- 309,-	65116	7400,- 309,-	84353
klika / klika	Kč €	4620,- 193,-	65567	4800,- 200,-	65598	4800,- 200,-	060676	5930,- 248,-	055429			5930,- 248,-	65628
madlo / klika R	Kč €	5930,- 248,-	65574	6090,- 254,-	65604	6090,- 254,-	060683	7400,- 309,-	055436			7400,- 309,-	65635
madlo / klika L	Kč €	5930,- 248,-	65581	6090,- 254,-	65611	6090,- 254,-	060690	7400,- 309,-	055443			7400,- 309,-	65642

U kombinace madlo / klika dodáváme standardně madlo Minimal pevné - neočtné. Na základě požadavku madlo Entero pevné - neočtné. Lze dodat madlo Entero otočné s funkcí kliky. V balení je standardně montážní materiál pro tl. dveří 38 - 45 mm. Nad 45 mm je třeba uvádět přesnou tl. dveří. Cena montážního materiálu pro jiné tl. dveří je zahrnuta v ceně kování.



		Sni		Sni - broušeno		Cr		Ms		TiN-C		TiN-B		TiN-K	
		cena / pár	EAN	cena / pár	EAN	cena / pár	EAN	cena / pár	EAN	cena / pár	EAN	cena / pár	EAN	cena / pár	EAN
Minimal madlo/madlo	Kč €	5460,- 228,-	026931	5540,- 231,-	026962	5610,- 234,-	026993	5610,- 234,-	060737	6770,- 283,-	027020	6770,- 283,-	027051	6770,- 283,-	027082
Entero madlo/madlo	Kč €	5120,- 214,-	026948	5210,- 218,-	026979	5290,- 221,-	027006	5290,- 221,-	060744	6430,- 268,-	027037	6430,- 268,-	027068	6430,- 268,-	027099
rozeta cylindrická	Kč €	840,- 35,-	001952	880,- 37,-	001969	930,- 39,-	001976	930,- 39,-	060775	1330,- 56,-	001983	1330,- 56,-	002669	1330,- 56,-	002676
rozeta *) cylindrická s překrytkou	Kč €	1330,- 56,-	030884	1380,- 58,-	030891	1410,- 59,-	030907	1410,- 59,-	060782	1830,- 77,-	030914	1830,- 77,-	030921	1830,- 77,-	030938
rozeta zaslepovací	Kč €	990,- 42,-	022353	1060,- 45,-	022360	1160,- 49,-	022377	1160,- 49,-	060799	1330,- 56,-	022384	1330,- 56,-	022391	1330,- 56,-	022407

		Objekt nerez NRz		Objekt titan TiN-K		Objekt K-industrial		Projekt tř. 4, (i protipožární) NRz		Projekt tř. 4, (i protipožární) TiN-K	
		cena / pár	EAN	cena / pár	EAN	cena / pár	EAN	cena / pár	EAN	cena / pár	EAN
Entero madlo/madlo	Kč €	4830,- 202,-	027143	6070,- 253,-	027150	6070,- 253,-	034042	5140,- 215,-	027167	6390,- 267,-	027174

		NRz		TiN-K		K-industrial	
		cena / pár	EAN	cena / pár	EAN	cena / pár	EAN
rozeta cylindrická	Kč €	940,- 40,-	024098	1260,- 53,-	024111	1260,- 53,-	034059
rozeta cylindrická s překrytkou *)	Kč €	1400,- 59,-	030952	1720,- 72,-	030969	1720,- 72,-	034066
rozety zaslepovací	Kč €	1090,- 46,-	024104	1400,- 59,-	024128	1400,- 59,-	034073

\*) Při objednání rozety s překrytkou je třeba uvádět orientaci dveří (levé / pravé) a směr otevírání (ven / dovnitř).



NRz nerez - broušeno



materiál: nerezová ocel  
povrch: NRz nerez - broušeno

Kč

EUR

**Lusy**

2030,-



85,-

2030,- Kč  
85,- EUR

2800,-



117,-

2800,-



117,-

**Hanna**

2330,-



98,-

2330,- Kč  
98,- EUR

3110,-



130,-

3110,-



130,-

**Morgan**

2180,-



91,-

2180,- Kč  
91,- EUR

2950,-



123,-

2950,-



123,-

**Entero**

2800,-



117,-

2800,- Kč  
117,- EUR

3590,-



150,-

3590,-



150,-

**Cesan**

2500,-



105,-

2500,- Kč  
105,- EUR

3260,-



136,-

3260,-



136,-

**Promo**

2800,-



117,-

2800,- Kč  
117,- EUR

3590,-



150,-

3590,-



150,-



		Objekt nerez		Objekt titan		Objekt		Projekt tř. 4,		Projekt tř. 4,	
		NRz		TiN-K		K-industrial		NRz		TiN-K	
		cena / pár	EAN	cena / pár	EAN	cena / pár	EAN	cena / pár	EAN	cena / pár	EAN
klika / klika	Kč €	2030,- 85,-	024623	3260,- 136,-	024654	3260,- 136,-	034080	2330,- 98,-	024685	3590,- 150,-	024715
madlo / klika R	Kč €	2800,- 117,-	024630	4040,- 169,-	024661	4040,- 169,-	034097	3110,- 130,-	024692	4350,- 182,-	024722
madlo / klika L	Kč €	2800,- 117,-	024647	4040,- 169,-	024678	4040,- 169,-	034103	3110,- 130,-	024708	4350,- 182,-	024739
klika / klika	Kč €	2330,- 98,-	046861	3590,- 150,-	102048	3590,- 150,-	144307	2640,- 110,-	102079	3880,- 162,-	102109
madlo / klika R	Kč €	3110,- 130,-	046878	4350,- 182,-	102055	4350,- 182,-	144314	3420,- 143,-	102086	4650,- 194,-	102116
madlo / klika L	Kč €	3110,- 130,-	046885	4350,- 182,-	102062	4350,- 182,-	144321	3420,- 143,-	102093	4650,- 194,-	102123
klika / klika	Kč €	2180,- 91,-	024869	3420,- 143,-	024890	3420,- 143,-	034172	2500,- 105,-	024920	3730,- 156,-	024951
madlo / klika R	Kč €	2950,- 123,-	024876	4190,- 175,-	024906	4190,- 175,-	034189	3260,- 136,-	024937	4510,- 188,-	024968
madlo / klika L	Kč €	2950,- 123,-	024883	4190,- 175,-	024913	4190,- 175,-	034196	3260,- 136,-	024944	4510,- 188,-	024975
klika / klika	Kč €	2800,- 117,-	024746	4040,- 169,-	024777	4040,- 169,-	034325	3110,- 130,-	024807	4350,- 182,-	024838
madlo / klika R	Kč €	3590,- 150,-	024753	4820,- 201,-	024784	4820,- 201,-	034332	3880,- 162,-	024814	5120,- 214,-	024845
madlo / klika L	Kč €	3590,- 150,-	024760	4820,- 201,-	024791	4820,- 201,-	034349	3880,- 162,-	024821	5120,- 214,-	024852
klika / klika	Kč €	2500,- 105,-	026818	3730,- 156,-	026849	3730,- 156,-	034417	2800,- 117,-	026870	4040,- 169,-	026900
madlo / klika R	Kč €	3260,- 136,-	026825	4510,- 188,-	026856	4510,- 188,-	034424	3590,- 150,-	026887	4820,- 201,-	026917
madlo / klika L	Kč €	3260,- 136,-	026832	4510,- 188,-	026863	4510,- 188,-	034431	3590,- 150,-	026894	4820,- 201,-	026924
klika / klika	Kč €	2800,- 117,-	025743			4040,- 169,-	034295	3110,- 130,-	025804		
madlo / klika R	Kč €	3590,- 150,-	025750			4820,- 201,-	034301	3880,- 162,-	025811		
madlo / klika L	Kč €	3590,- 150,-	025767			4820,- 201,-	034318	3880,- 162,-	025828		

U kombinace madlo / klika dodáváme standardně madlo Entero pevné - neotočné.  
Cena montážního materiálu pro jiné tloušťky dveří je zahrnuta v ceně kování.



Příbuzný sortiment

Madla a koule na skleněné  
a dřevěné dveře



Mušle Minimal / Maximal  
na skleněné posuvné dveře



Madla dlouhá



Posuvný systém MINIMA pro dřevěné  
a skleněné dveře



## Mušle na posuvné dveře

Mušle na posuvné dveře M&T jsou připraveny v 7-mi designových řadách, kdy každá řada má svoji charakteristiku použití. Mušle Entero a Entry jsou také ve variantě s WC ohebným mechanismem, kdy se posuvné dveře můžou celé bez omezení zasunout do stavebního pouzdra, stejně tak mušle Minimal II / Maximal II, které jsou navíc ve variantách se všemi typy zámeků, s různými možnostmi zamykání, s velmi rychlou a přesnou montáží a to z nich činí naprostou jedničku nejen v nabídce M&T ...

Materiál: **masivní mosaz** 

Povrchy: **SNi, Cr, SNi-broušeno, TiN-C, TiN-B, TiN-K, Ms, Ms-L, zakázkově TiN-A**  
více info na [www.kliky-mt.cz/manufaktura/barvy-povrchy](http://www.kliky-mt.cz/manufaktura/barvy-povrchy)

Materiál: **nerezová ocel**

Povrchy: **NRz, K-industrial**

**ENTERO SNi**  
matný nikl

**MAYA SNi**  
matný nikl

**MINIMAL Cr**  
lesklý chrom

**MINIMAL II SNi**  
matný nikl

**ENTRY TiN-K**  
titan čený mat

**ENTERO II NRz**  
nerez broušeno

**NOVA NRz**  
nerez broušeno



1. v naší nabídce

### Variety provedení

Standard  
Standard s pouzdry  
WC  
WC s pouzdry  
Ohebné WC  
Ohebné WC s pouzdry

Standard  
Dozické  
Cylindrické  
WC  
Sklo

Standard  
Dozické  
Cylindrické  
Ohebné WC

Standard  
Dozické  
Cylindrické  
Ohebné WC

Standard  
Dozické  
Cylindrické  
Ohebné WC

Standard  
WC s rozetou

Standard  
WC s rozetou

### Variety povrchových úprav

SNi, SNi-broušeno

SNi

SNi, Cr, SNi-broušeno,  
TiN-C, TiN-B,  
TiN-K, TiN-A, Ms

SNi, Cr, TiN-K

SNi, TiN-K

NRz

NRz

### konstrukční varianty

- sady muší se zamykáním jsou dodávány vždy v ceně se zadlabacím zámkem
- mušle bez zamykání jsou montážně připraveny pro dveře od minimální tloušťky 37 mm
- mušle se zamykáním jsou montážně připraveny pro dveře od minimální tloušťky 39 mm
- mušle s ohebným WC lze celé bez omezení zasunout do stavebního pouzdra
- k mušlím je připraven boční úchyt Entero pro snadné vysouvání dveří ze stavebního pouzdra
- výkresy frézování, animace montáže na [www.kliky-mt.cz/montaze-kovani](http://www.kliky-mt.cz/montaze-kovani)
- mušle Entero s pouzdry se montují pomocí šroubků proti sobě
- mušle Maya se montují pomocí šroubků proti sobě
- mušle Minimal a Minimal II se montují pomocí šroubků proti sobě
- mušle Entry se montují pomocí šroubků proti sobě
- mušle Entero NRz a Nova NRz se fixují skrytými vruty do stěny dveří
- záruka 3 roky, NRz 5 let, titány 15 let

roky **3 garance** let **5 garance** let **15 garance**

### Ochranné známky – registrované značky

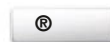

**ENTERO®**  
**MINIMAL®**  
**MAXIMAL®**

### Chráněné průmyslové vzory muší



**MINIMAL**  
**MAXIMAL**  
**MINIMAL II**  
**MAXIMAL II**  
**ENTRY**

### Patent



Konstrukce a systém tlačných pružin u muší Minimal, Maximal  
Konstrukce a systém montáže muší Minimal II / Maximal II, Entry



## Minimal II / Maximal II

### nejlepší mušle v naší nabídce

- nejdokonalejší montáž
- nejrychlejší montáž
- nejsnadnější montáž
- všechny varianty zamykání
- v setu se zámkem a protiplechem
- s magnetickou deskou / výplní pro dokonalý design
- ohebné WC, které nepřesahuje okraj mušle
- univerzální otvor frézování do dveří pro všechny varianty muší

Na magnetickou desku uvnitř mušle se vkládá výplň totožná s povrchem křídla dveří pro neviditelný efekt mušle Maximal.



**MINIMAL II SNI**  
matný nikl



**Cr** lesklý chrom



**TiN-K** titan černý mat



**MAXIMAL II SNI** matný nikl  
výplň dřevo - dýha teak



**TiN-K** titan černý mat  
výplň dřevo - dýha teak



SNI matný nikel

**Mušle Minimal II**

990,- Kč  
42,- EUR



TiN-K titan černý mat

**Mušle Maximal II**

990,- Kč  
42,- EUR



Maximal Cr lesklý chrom + výplň efekt „sklo“ - bílá glanz

**Výplň mušle Maximal II**

320,- Kč  
14,- EUR

materiál: kovové tělo + magnetická výplň  
Kč povrch: SNI matný nikel EUR

Kč	EUR
990,-	42,-
2760,-	115,-
2760,-	115,-
3940,-	165,-



Kč	EUR
990,-	42,-
2760,-	115,-
2760,-	115,-
3940,-	165,-



		SNI		Cr		TiN-K	
		cena	EAN	cena	EAN	cena	EAN
standard	Kč €	ks 990,- 42,-	101751	ks 1280,- 54,-	101768	ks 1710,- 72,-	101775
dozická	Kč €	pár 2760,- 115,-	101782	pár 3200,- 134,-	101799	pár 4180,- 175,-	101805
cylindrická	Kč €	pár 2760,- 115,-	101812	pár 3200,- 134,-	101829	pár 4180,- 175,-	101836
WC / koupelna	Kč €	pár 3940,- 165,-	101843	pár 4230,- 177,-	101850	pár 5510,- 230,-	101867

Sada se zadlabacím zámkem v barvě čela zámku podobné barvě mušlí, protiplechem a krycí vaničkou.

		SNI		Cr		TiN-K	
		cena	EAN	cena	EAN	cena	EAN
standard	Kč €	ks 990,- 42,-	101874	ks 1280,- 54,-	101881	ks 1710,- 72,-	101898
dozická	Kč €	pár 2760,- 115,-	101904	pár 3200,- 134,-	101911	pár 4180,- 175,-	101928
cylindrická	Kč €	pár 2760,- 115,-	101935	pár 3200,- 134,-	101942	pár 4180,- 175,-	101959
WC / koupelna	Kč €	pár 3940,- 165,-	101966	pár 4230,- 177,-	101973	pár 5510,- 230,-	101980

Sada se zadlabacím zámkem v barvě čela zámku podobné barvě mušlí, protiplechem a krycí vaničkou.

		cena	EAN
		pár	
dřevo	Kč €	320,- 14,-	001778
kov	Kč €	320,- 14,-	001785
kůže	Kč €	430,- 18,-	001792
efekt „sklo“	Kč €	430,- 18,-	001808
RAL barvy	Kč €	470,- 20,-	022506

více informací na str. 290 - 291 Mušle na posuvné dveře  
Výplně k mušlím Maximal i Maximal II se objednávají pod stejným EAN.







Možnost vložení / instalace různých povrchů a materiálů do mušle pomocí magnetické desky.



**Mušle Entry**

930,- Kč  
39,- EUR

Kč	materiál: povrch: SNI matný nikel	EUR
930,-		39,-
2460,-		103,-
2460,-		103,-
3070,-		128,-



TiN-K titan černý mat



SNI matný nikel



	SNI		TiN-K		
	cena	EAN	cena	EAN	
standard	Kč €	ks 930,- 39,-	155693	ks 1560,- 65,-	155730
dozická	Kč €	pár 2460,- 103,-	155709	pár 3740,- 156,-	155747
cyklindrická	Kč €	pár 2460,- 103,-	155716	pár 3740,- 156,-	155754
WC / koupelna	Kč €	pár 3070,- 128,-	155723	pár 4850,- 203,-	155761

Sada se zadlabacím zámkem v barvě čela zámku podobné barvě mušlí, protiplechem a krycí vaničkou.





SNi matný nikl



TiN-K titan černý mat  
WC



WC s pouzdry



ohébné WC



ohébné WC s pouzdry



SNi matný nikl



**Mušle Entero**

1090,- Kč  
46,- EUR

Kč	EUR
1090,-	46,-
1090,-	46,-
3110,-	130,-
3110,-	130,-
3420,-	143,-
3420,-	143,-

**Mušle Maya**

2640,- Kč  
110,- EUR

Kč	EUR
2640,-	110,-
3110,-	130,-
3110,-	130,-
3880,-	162,-
2950,-	123,-

		SNI		SNI - broušeno		TiN-K*	
		cena	EAN	cena	EAN	cena	EAN
standard	Kč €	ks 1090,- 46,-	74095	ks 1160,- 49,-	74118	ks 2030,- 85,-	066456
standard s pouzdry	Kč €	ks 1090,- 46,-	74361	ks 1160,- 49,-	74385	ks 2030,- 85,-	066463
WC	Kč €	pár 3110,- 130,-	17863	pár 3260,- 136,-	17856	pár 5120,- 214,-	066470
WC s pouzdry	Kč €	pár 3110,- 130,-	17917	pár 3260,- 136,-	17931	pár 5120,- 214,-	066487
s ohebným WC	Kč €	pár 3420,- 143,-	89389	pár 3590,- 150,-	89402	pár 5430,- 227,-	066494
s ohebným WC s pouzdry	Kč €	pár 3420,- 143,-	89396	pár 3590,- 150,-	89419	pár 5430,- 227,-	066500

Sada se zadlabacím zámkem v barvě čela zámku podobné barvě mušlí, protiplechem a krycí vaničkou.

\* Upozorňujeme na možnost hrubšího povrchu uvnitř mušle. Hrubší povrch nemá omezení týkající se manipulace s mušlí a pohledově nenarušuje celkový vzhled mušle.

		SNI	
		cena / pár	EAN
standard	Kč €	2640,- 110,-	61842
dozická	Kč €	3110,- 130,-	61859
cyklindrická	Kč €	3110,- 130,-	61866
WC	Kč €	3880,- 162,-	61873
na sklo	Kč €	2950,- 123,-	61880

Sada se zadlabacím zámkem v barvě čela zámku podobné barvě mušlí, protiplechem a krycí vaničkou.



MINIMAL SNI  
matný nikl

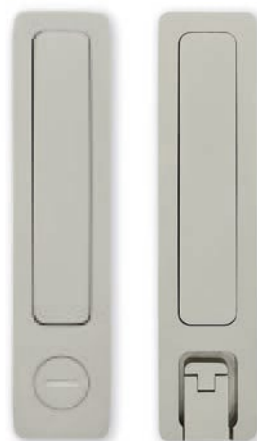

**Mušle Minimal**

6110,- Kč  
255,- EUR

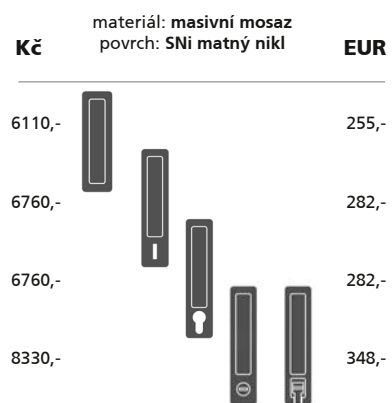

MAXIMAL SNI matný nikl  
výplň dřevo - dýha teak

**Mušle Maximal**

6110,- Kč  
255,- EUR

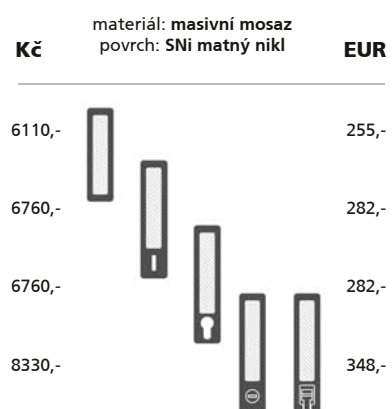

**Výplň mušle  
Maximal**

320,- Kč  
14,- EUR





	SNi		SNi - broušeno		Cr		Ms		TiN-C		TiN-B		TiN-K	
	cena	EAN	cena	EAN	cena	EAN	cena	EAN	cena	EAN	cena	EAN	cena	EAN
	Kč		Kč		Kč		Kč		Kč		Kč		Kč	
	€		€		€		€		€		€		€	
standard	6110,- 255,-	001211	6310,- 263,-	001228	6420,- 268,-	001235	6420,- 268,-	060836	7840,- 327,-	001242	7840,- 327,-	001259	7840,- 327,-	001266
dozická	6760,- 282,-	001280	6960,- 290,-	001297	7060,- 295,-	001303	7060,- 295,-	060843	8530,- 356,-	001310	8530,- 356,-	001327	8530,- 356,-	001334
cylindrická	6760,- 282,-	001358	6960,- 290,-	001365	7060,- 295,-	001372	7060,- 295,-	060850	8530,- 356,-	001389	8530,- 356,-	001396	8530,- 356,-	001402
WC / koupelna	8330,- 348,-	001426	8560,- 357,-	001433	8750,- 365,-	001440	8750,- 365,-	060867	10260,- 428,-	001457	10260,- 428,-	001464	10260,- 428,-	001471

Sada se zadlabacím zámkem v barvě čela zámku podobné barvě mušlí (viz. barvy čela zámků na str. 354), protiplechem a krycí vaničkou.



SNi matný nikel



Cr lesklý chrom



TiN-C titan chrom mat



TiN-B titan braun mat



TiN-K titan černý mat



	SNi		SNi - broušeno		Cr		Ms		TiN-C		TiN-B		TiN-K	
	cena	EAN	cena	EAN	cena	EAN	cena	EAN	cena	EAN	cena	EAN	cena	EAN
	Kč		Kč		Kč		Kč		Kč		Kč		Kč	
	€		€		€		€		€		€		€	
standard	6110,- 255,-	001495	6310,- 263,-	001501	6420,- 268,-	001518	6420,- 268,-	060911	7840,- 327,-	001525	7840,- 327,-	001532	7840,- 327,-	001549
dozická	6760,- 282,-	001563	6960,- 290,-	001570	7060,- 295,-	001587	7060,- 295,-	060928	8530,- 356,-	001594	8530,- 356,-	001600	8530,- 356,-	001617
cylindrická	6760,- 282,-	001631	6960,- 290,-	001648	7060,- 295,-	001655	7060,- 295,-	060935	8530,- 356,-	001662	8530,- 356,-	001679	8530,- 356,-	001686
WC / koupelna	8330,- 348,-	001709	8560,- 357,-	001716	8750,- 365,-	001723	8750,- 365,-	060942	10260,- 428,-	001730	10260,- 428,-	001747	10260,- 428,-	001754

	cena	EAN
	Kč	
	€	
dřevo	320,- 14,-	001778
kov	320,- 14,-	001785
kůže	430,- 18,-	001792
efekt „sklo“	430,- 18,-	001808
RAL barvy	470,- 20,-	022506

Sada se zadlabacím zámkem v barvě čela zámku podobné barvě mušlí (viz. barvy čela zámků na str. 354), protiplechem a krycí vaničkou.



**Mušle Entero II**

780,- Kč  
33,- EUR

Kč	materiál: nerezová ocel povrch: NRz nerez - broušeno	EUR
780,-		33,-
2330,-		98,-



**Mušle Nova**

470,- Kč  
20,- EUR

Kč	materiál: nerezová ocel povrch: NRz nerez - broušeno	EUR
470,-		20,-
1850,-		78,-



**Boční úchyt Entero II**

320,- Kč  
14,- EUR

Kč	materiál: nerezová ocel povrch: NRz nerez - broušeno	EUR
320,-		14,-



**Boční úchyt Entero**

320,- Kč  
14,- EUR

Kč	EUR
320,-	14,-



**Boční úchyt Nova**

280,- Kč  
12,- EUR

Kč	EUR
280,-	12,-



		NRz		K-industrial	
		cena	EAN	cena	EAN
150x50 mm	Kč €	ks 780,- 33,-	017816	ks 1540,- 65,-	034448
WC na plochých rozetách cena za pár včetně zámku	Kč €	pár 2330,- 98,-	017830	pár 4190,- 175,-	034455

Sada se zadlabacím zámkem v barvě čela zámku podobné barvě mušlí (viz. barvy čela zámků na str. 354), protiplechem a krycí vaničkou.

		NRz		K-industrial	
		cena	EAN	cena	EAN
120x40 mm	Kč €	ks 470,- 20,-	017854	ks 1250,- 53,-	034462
WC Burak na plochých rozetách cena za pár včetně zámku	Kč €	pár 1850,- 78,-	017878	pár 3420,- 143,-	034479

Sada se zadlabacím zámkem v barvě čela zámku podobné barvě mušlí (viz. barvy čela zámků na str. 354), protiplechem a krycí vaničkou.

		NRz		K-industrial	
		cena / ks	EAN	cena / ks	EAN
	Kč €	320,- 14,-	037555	590,- 25,-	037562

		SNI		Cr		TiN-K		K-industrial	
		cena / ks	EAN	cena / ks	EAN	cena / ks	EAN	cena / ks	EAN
	Kč €	320,- 14,-	17894	320,- 14,-	17900	590,- 25,-	093612	590,- 25,-	145144

		SNI		Cr		TiN-K		K-industrial	
		cena / ks	EAN	cena / ks	EAN	cena / ks	EAN	cena / ks	EAN
	Kč €	280,- 12,-	082197	280,- 12,-	087321	560,- 24,-	087338	560,- 24,-	145151

## Úchyt PUSH

Univerzální minimalistický úchyt s použitím na posuvné dveře jako boční úchyt, nebo na dřevěné obložení stěn jako věšáček.

PUSH vyniká svým elegantním ovládním a nenápadným čistým vzhledem.





PUSH se k dveřnímu křídlu přisazuje a přečnívá pouhých 2,5 mm nad povrch dveří s plynulým zkosením na 0,5 mm. Úplně zapuštění nedoporučujeme.

Montáž se provádí pomocí silného magnetu. U jednostranných dveří, nebo obložení stěn lze montovat pomocí šroubků skrz materiál.



### Úchyt PUSH

870,- Kč  
37,- EUR

Kč	materiál: masivní mosaz povrch: SNi matný nikl	EUR
870,-		37,-
940,-		40,-
950,-		40,-
990,-		42,-



		SNI		TiN-K	
		cena	EAN	cena	EAN
kulatý	Kč €	870,- 37,-	132724	1150,- 48,-	132762
kulatý + magnet	Kč €	940,- 40,-	132731	1190,- 50,-	132779
hrnatý	Kč €	950,- 40,-	132748	1210,- 51,-	132786
hrnatý + magnet	Kč €	990,- 42,-	132755	1270,- 53,-	132793





Příbuzný sortiment

Kliky a zámky na skleněné dveře



Panty na skleněné dveře



Mušle na posuvné dveře



Madla dlouhá



Posuvný systém MINIMA pro dřevěné a skleněné dveře



Madla a koule na skleněné a dřevěné dveře



## Mušle Minimal / Maximal na skleněné posuvné dveře

Materiál: masivní mosaz   
Povrchy: SNI, Cr, SNI-broušeno, TiN-C, TiN-B, TiN-K, Ms, Ms-L, zakázkově TiN-A  
více info na [www.kliky-mt.cz/manufaktura/barvy-povrchy](http://www.kliky-mt.cz/manufaktura/barvy-povrchy)

Mušle Minimal / Maximal na skleněné dveře mají jedinečnost v barevnostní nabídce povrchových úprav. U žádné další firmy nenajdete v nabídce produkty na skleněné dveře, které lze barevně a designově sladit s produkty na dřevěné dveře. Využijte výjimečnosti mušlí Minimal / Maximal a sladte si interiér do posledního detailu.

**MINIMAL TIN-K** titan černý mat



**MAXIMAL Cr** lesklý chrom + výplň sklo - bílá glanz



### konstrukční varianty

- pro montáž na tl. skla 8-10 mm
- tloušťku skla je potřeba specifikovat
- velmi rychlá a jednoduchá montáž
- výkresy vrtání ve specializovaném katalogu M&T GLASS, nebo na [www.kliky-mt.cz](http://www.kliky-mt.cz)
- záruka 3 roky, titany 15 let

roky **3 garance** let **15 garance**

Ochranné známky – registrované značky

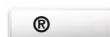

**MINIMAL®**  
**MAXIMAL®**

Chráněné průmyslové vzory mušle



**MINIMAL**  
**MAXIMAL**

Patent



Konstrukce a systém tlačných pružin  
u mušlí Minimal / Maximal





**SNi** matný nikel



**Cr** lesklý chrom



**TiN-K** titan černý mat

**Mušle na sklo**

**Minimal**

5260,-

**Maximal**

5260,-

5260,- Kč  
220,- EUR

materiál: masivní mosaz  
povrch: SNi matný nikel

**Kč**

**EUR**

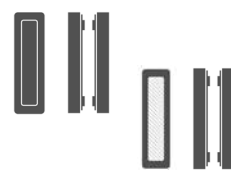

220,-

220,-

**Výplň mušle  
Maximal**

320,- Kč  
14,- EUR



**Maximal Cr** lesklý chrom + výplň efekt „sklo“ - bílá glanz

	SNI		SNI - broušeno		Cr		Ms		TiN-C		TiN-B		TiN-K	
	cena	EAN	cena	EAN	cena	EAN	cena	EAN	cena	EAN	cena	EAN	cena	EAN
	Kč		Kč		Kč		Kč		Kč		Kč		Kč	
	€		€		€		€		€		€		€	
Minimal	5260,-	002522	5330,-	002539	5440,-	002546	5440,-	060997	6830,-	002553	6830,-	002560	6830,-	002577
	220,-		223,-		227,-		227,-		285,-		285,-		285,-	
Maximal	5260,-	002591	5330,-	002607	5440,-	002614	5440,-	061000	6830,-	002621	6830,-	002638	6830,-	002645
	220,-		223,-		227,-		227,-		285,-		285,-		285,-	

		cena	EAN
		pár	
dřevo	Kč	320,-	001778
	€	14,-	
kov	Kč	320,-	001785
	€	14,-	
kůže	Kč	430,-	001792
	€	18,-	
efekt „sklo“	Kč	430,-	001808
	€	18,-	
RAL barvy	Kč	470,-	022506
	€	20,-	



TiN-B titan braun mat



TiN-C titan chrom mat



SNI matný nikel - broušeno



Příbuzný sortiment

Rozetové kování



Panty na skleněné dveře



Mušle Minimal / Maximal  
na skleněné posuvné dveře



Madla dlouhá



Posuvný systém MINIMA  
pro dřevěné a skleněné dveře



Madla a koule na skleněné  
a dřevěné dveře





## Kliky a zámky na skleněné dveře

Materiál: masivní mosaz 

Povrchy: SNI, Cr, SNI-broušeno, TiN-C, TiN-B, TiN-K, Ms, Ms-A, Ms-L, K-industrial, zakázkově TiN-A  
více info na [www.kliky-mt.cz/manufaktura/barvy-povrchy](http://www.kliky-mt.cz/manufaktura/barvy-povrchy)

Produkce zámků a klik M&T na skleněné dveře je jasnou výzvou pro příznivce pokročilého designu. V nabídce najdete kování vždy ve stejném designu a několika odstínech povrchové úpravy včetně pantů na sklo, což představuje naprostý unikát. Podobnou variabilitu nenajdete nikde jinde - u žádného výrobce nebo dovozce kování. Objevte maximální výhody této nabídky a svůj projekt dovedte do dokonalosti.

MINI



ENTERO



MINIMAL



TRINITY



### Varianty provedení

Standard

Standard

Standard

Standard

WC

WC

WC

WC

Protikus na dvoukřídlé dveře

Protikus na dvoukřídlé dveře

Protikus na dvoukřídlé dveře

Cylindrický

Cylindrický

### konstrukční varianty, materiálové provedení

- pro montáž na tl. skla 8-10 mm
- tloušťku skla je potřeba specifikovat
- výkresy vrtání ve specializovaném katalogu M&T GLASS nebo na [www.kliky-mt.cz](http://www.kliky-mt.cz)
- zámky Minimal a Maximal jsou s kompletní variabilitou povrchů a výplní jako u klik na dřevěné dveře
- řady zámků Mini, Entero, Trinity je možno kombinovat s jakoukoliv rukojetí z masivní mosazi z produkce M&T
- záruka 3 roky, titany 15 let

roky **3 garance**

let **15 garance**

### Ochranné známky – registrované značky

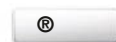

**ENTERO®**  
**MINIMAL®**  
**MAXIMAL®**  
**MINI®**

### Chráněné průmyslové vzory klik



**veškeré chráněné designy klik M&T**

zámků na sklo

**MINIMAL**  
**MAXIMAL**





**TiN-C** titan chrom mat  
klíka Sogut

**Zámek Entero**

7900,- Kč  
330,- EUR



**SNi** matný nikl cylindrický  
klíka Mimolimit + teak



**Cr** lesklý chrom WC  
klíka Terry

**Klíky-rukojeti  
k zámkům na sklo**



**TiN-K** titan černý mat  
klíka Mimolimit + jilm

**Kč** materiál: masivní mosaz  
povrch: SNi matný nikl **EUR**

7900,-		330,-
7990,-		333,-
9170,-		383,-
9280,-		387,-

**Kč** materiál: masivní mosaz  
povrch: SNi matný nikl broušeno **EUR**

2650,-	Maya 	111,-
2500,-	Toro 	105,-
2500,-	Tukan 	105,-
2500,-	Mimolimit 	105,-

**Kč** materiál: masivní mosaz  
povrch: SNi matný nikl broušeno **EUR**

2240,-	Entry 	94,-
1920,-	Trinity 	80,-
2070,-	My 	87,-
2070,-	Terry 	87,-



		SNI		SNI - broušeno		Cr		Ms		TiN-C		TiN-K		TiN-B		K-industrial	
		cena	EAN	cena	EAN	cena	EAN	cena	EAN	cena	EAN	cena	EAN	cena	EAN	cena	EAN
standard	Kč €	7900,- 330,-	87750	7900,- 330,-	90736	8680,- 362,-	87675	8680,- 362,-	061031	9870,- 412,-	87835	10280,- 429,-	87798	10660,- 445,-	90774	10280,- 429,-	137859
cylindrický	Kč €	7990,- 333,-	87767	7990,- 333,-	90743	8800,- 367,-	87682	8800,- 367,-	061048	9980,- 416,-	87842	10350,- 432,-	87804	10740,- 448,-	90781	10350,- 432,-	137866
WC	Kč €	9170,- 383,-	87774	9170,- 383,-	90750	9960,- 415,-	87699	9960,- 415,-	061055	11160,- 465,-	87859	11530,- 481,-	87811	11930,- 498,-	90798	11530,- 481,-	137873
protikus	Kč €	9280,- 387,-	87781	9280,- 387,-	90767	10160,- 424,-	87705	10160,- 424,-	061062	11470,- 478,-	87866	11850,- 494,-	87828	12250,- 511,-	90804	11850,- 494,-	137880

Pro tl. dveří 10 mm jsou v případě potřeby připraveny zámky se sníženou/užší střílkou o 2 mm... EAN 068498 příplatek ke katalogové ceně zámku + 730 Kč bez další slevy.



SNI matný nikl + protikus  
klicka Entero

		SNI - broušeno		Ms		TiN-C		TiN-K		TiN-B	
		cena / pár	EAN	cena / pár	EAN	cena / pár	EAN	cena / pár	EAN	cena / pár	EAN
Maya	Kč €	2650,- 111,-	19041	2730,- 114,-	061116	3320,- 139,-	19058			3320,- 139,-	19065
Toro	Kč €	2500,- 105,-	19119	2570,- 108,-	061123	3150,- 132,-	19126			3150,- 132,-	19133
Tukan	Kč €	2500,- 105,-	19140	2570,- 108,-	061130	3150,- 132,-	19157			3150,- 132,-	19164
Mimolimit	Kč €	2500,- 105,-	19072	2420,- 101,-	061147	3150,- 132,-	19089	3150,- 132,-	19096	3150,- 132,-	19102

Kliky - rukojeti jsou připraveny se zvýhodněnou cca 50% slevou oproti klikám s rozetou. Uvedená cena je za pár klik - rukojeti.  
Všechny typy klik je možné kombinovat se všemi typy zámků (mimo samostatnou kolekci Minimal / Maximal).



		SNI - broušeno		Cr		Ms		TiN-C		TiN-K	
		cena / pár	EAN	cena / pár	EAN	cena / pár	EAN	cena / pár	EAN	cena / pár	EAN
Entry	Kč €	2240,- 94,-	12912	2320,- 97,-	12905	2320,- 97,-	061192	2820,- 118,-	12929	2820,- 118,-	12936
Trinity	Kč €	1920,- 80,-	12950	1980,- 83,-	12943	1980,- 83,-	061208	2500,- 105,-	12967	2500,- 105,-	12974
My	Kč €	2070,- 87,-	12998	2160,- 90,-	12981	2160,- 90,-	061215	2650,- 111,-	18983	2650,- 111,-	18990
Terry	Kč €	2070,- 87,-	19010	2160,- 90,-	19003	2160,- 90,-	061222	2650,- 111,-	19027	2650,- 111,-	19034



**Cr lesklý chrom**  
klika Mini-T

**Zámek Mini**

5860,- Kč  
245,- EUR

Kč	materiál: masivní mosaz povrch: SNI matný nikel	EUR
5860,-		245,-
6980,-		291,-
7100,-		296,-



**TiN-K titan černý mat**  
klika Mimolimit Alu kompakt

**Kliky-rukojeti  
k zámkům na sklo**

Kč	materiál: masivní mosaz povrch: SNI matný nikel	EUR
1170,-	Mini-V 	49,-
930,-	Mini-C 	39,-
1090,-	Mini-T 	46,-
1010,-	Mini-S 	43,-



**SNI-broušeno** matný nikel broušeno  
klika Lara



**TiN-K titan černý mat**  
klika Mini-V



**TiN-B titan braun mat**  
klika Tukan



		SNI		SNI - broušeno		Cr		Ms		TiN-C		TiN-K		TiN-B	
		cena	EAN	cena	EAN	cena	EAN	cena	EAN	cena	EAN	cena	EAN	cena	EAN
standard	Kč €	5860,- 245,-	87934	5860,- 245,-	90811	6400,- 267,-	87873	6400,- 267,-	061277	7640,- 319,-	87996	7990,- 333,-	87965	8340,- 348,-	88023
WC	Kč €	6980,- 291,-	87941	6980,- 291,-	90828	7510,- 313,-	87880	7510,- 313,-	061284	8760,- 365,-	88009	9100,- 380,-	87972	9480,- 395,-	88030
protikus	Kč €	7100,- 296,-	87958	7100,- 296,-	90835	7640,- 319,-	87897	7640,- 319,-	061291	9060,- 378,-	88016	9400,- 392,-	87989	9770,- 408,-	88047

Pro tl. dveří 10 mm jsou v případě potřeby připraveny zámky se sníženou/užší střelkou o 2 mm... EAN 068498 příplatek ke katalogové ceně zámku + 730 Kč bez další slevy.



SNI matný nikl + protikus  
klika Mini-C



		SNI		Cr		Ms		TiN-K	
		cena / pár	EAN	cena / pár	EAN	cena / pár	EAN	cena / pár	EAN
Mini-V	Kč €	1170,- 49,-	19171	1260,- 53,-	19188	1260,- 53,-	061338	1510,- 63,-	19195
Mini-C	Kč €	930,- 39,-	19201	1010,- 43,-	19218	1010,- 43,-	061345	1260,- 53,-	19225
Mini-T	Kč €	1090,- 46,-	19232	1170,- 49,-	19249	1170,- 49,-	061352	1410,- 59,-	19256
Mini-S	Kč €	1010,- 43,-	19263	1090,- 46,-	19270	1090,- 46,-	061369	1340,- 56,-	19287

Klíky - rukojeti jsou připraveny se zvýhodněnou cca 50% slevou oproti klikám s rozetou. Uvedená cena je za pár klik - rukojetí. Všechny typy klik je možné kombinovat se všemi typy zámků (mimo samostatnou kolekci Minimal / Maximal).



SNI matný nikl  
západka s podlahovým pouzdem

západka + protikus do zárubně

### Západka k dvoukřídlým dveřím

Západka k dvoukřídlým dveřím		SNI		SNI - br.		Cr		Ms		TiN-C		TiN-K		TiN-B	
		cena / ks	EAN	cena / ks	EAN	cena / ks	EAN	cena / ks	EAN	cena / ks	EAN	cena / ks	EAN	cena / ks	EAN
pro tl. skla 8-10 mm bez vrtání skla	Kč €	5430,- 227,-	89440	5430,- 227,-	90842	5430,- 227,-	89457	5430,- 227,-	078954	6300,- 263,-	89471	6300,- 263,-	89464	6300,- 263,-	89488

Dveřní západka je univerzální pro tl. skla 8 - 10 mm bez vrtání skla. Součástí dodávky je podlahové pouzdro pro uchycení do podlahy.

Protikus do zárubně		SNI		SNI - br.		Cr		Ms		TiN-C		TiN-K		TiN-B	
		cena / ks	EAN	cena / ks	EAN	cena / ks	EAN	cena / ks	EAN	cena / ks	EAN	cena / ks	EAN	cena / ks	EAN
	Kč €	550,- 23,-	078879	550,- 23,-	078886	640,- 27,-	078893	640,- 27,-	078930	730,- 31,-	078916	730,- 31,-	078909	730,- 31,-	078923

Při montáži západky na horní část dveřního křídla s fixací do horní zárubně je nutno přibojednat protikus do zárubně.

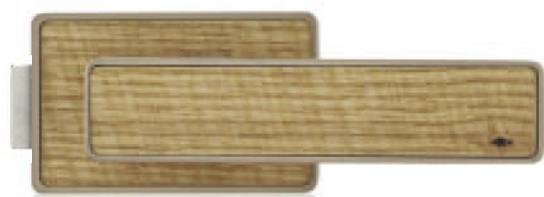

TiN-B titan braun mat + výplň dřevo - dýha 3D dub  
klika Maximal

**Zámek na sklo**

**Minimal**

7080,-



295,-

8200,-



342,-

**Maximal**

7580,-



316,-

7580,- Kč

316,- EUR

materiál: masivní mosaz  
povrch: SNi matný nikl

**Kč**

**EUR**



SNi matný nikl  
klika Minimal

**Výplň zámku na sklo**

**Maximal**

470,- Kč

20,- EUR



**Kliky**

**Minimal**

3920,-



164,-

**Maximal**

4350,-



182,-

4350,- Kč

182,- EUR

materiál: masivní mosaz  
povrch: SNi matný nikl

**Kč**

**EUR**



Cr lesklý chrom  
klika Minimal

**Výplň kliky**

**Maximal**

220,- Kč

9,2 EUR



**Protikus na sklo**

**Minimal**

7080,-



295,-

**Maximal**

7580,-



316,-

7580,- Kč

316,- EUR

materiál: masivní mosaz  
povrch: SNi matný nikl

**Kč**

**EUR**



Cr lesklý chrom + výplň efekt „sklo“ - bílá glanz  
klika Maximal

**Výplň protikusu na sklo**

**Maximal**

470,- Kč

20,- EUR





	SNI		SNI - broušeno		Cr		Ms		TiN-C		TiN-B		TiN-K		
	cena	EAN	cena	EAN	cena	EAN	cena	EAN	cena	EAN	cena	EAN	cena	EAN	
	pár		pár		pár		pár		pár		pár		pár		
Minimal standard	Kč €	7080,- 295,-	000788	7240,- 302,-	000795	7420,- 310,-	000801	7420,- 310,-	061413	8300,- 346,-	000818	8300,- 346,-	000825	8300,- 346,-	000832
Minimal WC	Kč €	8200,- 342,-	080797	8380,- 350,-	080803	8550,- 357,-	080810	8550,- 357,-	080827	9440,- 394,-	080841	9440,- 394,-	080865	9440,- 394,-	080858
Maximal standard	Kč €	7580,- 316,-	000856	7760,- 324,-	000863	7940,- 331,-	000870	7940,- 331,-	061420	8780,- 366,-	000887	8780,- 366,-	000894	8780,- 366,-	000900

Pro tl. dveří 10 mm jsou v případě potřeby připraveny zámky se sníženou/užší střílkou o 2 mm... EAN 068498 příplatek ke katalogové ceně zámku + 730 Kč bez další slevy.

	cena	EAN		cena	EAN		
	pár			pár			
dřevo	Kč €	470,- 20,-	000924	kůže	Kč €	560,- 24,-	000948
kov	Kč €	470,- 20,-	000931	efekt „sklo“	Kč €	560,- 24,-	000955

Kompletní sada **Minimal standard** na skleněné dveře se skládá ze zámku na sklo a klik s rozetou (tj. klika stejná jako u dřevěných dveří, která se i s rozetou montuje na zámeček na sklo).



	SNI		SNI - broušeno		Cr		Ms		TiN-C		TiN-B		TiN-K		
	cena	EAN	cena	EAN	cena	EAN	cena	EAN	cena	EAN	cena	EAN	cena	EAN	
	pár		pár		pár		pár		pár		pár		pár		
Minimal klika / klika	Kč €	3920,- 164,-	000009	4030,- 168,-	000016	4230,- 177,-	000023	4230,- 177,-	055115	5230,- 218,-	000030	5230,- 218,-	000047	5230,- 218,-	000054
Maximal klika / klika	Kč €	4350,- 182,-	000214	4440,- 185,-	000221	4670,- 195,-	000238	4670,- 195,-	062632	5640,- 235,-	000245	5640,- 235,-	000252	5640,- 235,-	000269

	cena	EAN	
	ks		
dřevo	Kč €	220,- 9,2	000429
kov	Kč €	220,- 9,2	000436
kůže	Kč €	320,- 14,-	000443
efekt „sklo“	Kč €	320,- 14,-	000450
RAL barvy	Kč €	320,- 14,-	022346

Kompletní sada **Minimal WC** na skleněné dveře se skládá ze zámku na sklo a klik Minimal s Al rozetou (tj. klika stejná jako na hliníkové a ocelové dveře, která se i s rozetou montuje na zámeček na sklo), str. 110 – 111.



	SNI		SNI - broušeno		Cr		Ms		TiN-C		TiN-B		TiN-K		
	cena	EAN	cena	EAN	cena	EAN	cena	EAN	cena	EAN	cena	EAN	cena	EAN	
	pár		pár		pár		pár		pár		pár		pár		
Minimal	Kč €	7080,- 295,-	000962	7240,- 302,-	000979	7420,- 310,-	000986	7420,- 310,-	061451	8300,- 346,-	000993	8300,- 346,-	001006	8300,- 346,-	001013
Maximal	Kč €	7580,- 316,-	001037	7760,- 324,-	001044	7940,- 331,-	001051	7940,- 331,-	061468	8780,- 366,-	001068	8780,- 366,-	001075	8780,- 366,-	001082

	cena	EAN	
	pár		
dřevo	Kč €	470,- 20,-	001105
kov	Kč €	470,- 20,-	001112
kůže	Kč €	560,- 24,-	001129
efekt „sklo“	Kč €	560,- 24,-	001136



SNI matný nikl + protikus klika Minimal



**SNi-broušeno** matný nikel broušeno  
klíka Trinity

**Zámek Trinity**

9400,- Kč  
392,- EUR

Kč	materiál: masivní mosaz povrch: SNi matný nikel	EUR
9400,-		392,-
9490,-		396,-
10540,-		440,-

**Klíky-rukojeti  
k zámkům na sklo**



**TiN-B** titan braun mat  
klíka Toro

Kč	materiál: masivní mosaz povrch: SNi matný nikel	EUR
830,-	Fábi	35,-
750,-	Burak	32,-
870,-	Garanti	37,-
750,-	Mia	32,-
630,-	Cesan	27,-
970,-	Lusy	41,-
830,-	Andy	35,-
970,-	Deny	41,-
920,-	Kemer	39,-
750,-	Meclis	32,-
1220,-	Mondeo	51,-
990,-	Maty	42,-
1180,-	Sogut	50,-
1380,-	Cherez	58,-
1430,-	Entero	60,-
1310,-	Lara	55,-





		SNI		SNI - broušeno		Cr		Ms		TiN-B	
		cena	EAN	cena	EAN	cena	EAN	cena	EAN	cena	EAN
standard	Kč €	9400,- 392,-	081275	9400,- 392,-	87590	9950,- 415,-	87552	9950,- 415,-	061499	11900,- 496,-	87613
cylindrický	Kč €	9490,- 396,-	081282	9490,- 396,-	90217	10030,- 418,-	90200	10030,- 418,-	061505	11970,- 499,-	90224
WC	Kč €	10540,- 440,-	081299	10540,- 440,-	87606	11070,- 462,-	87569	11070,- 462,-	061512	13030,- 543,-	87620

Pro tl. dveří 10 mm jsou v případě potřeby připraveny zámky se sníženou/užší střílkou o 2 mm... EAN 068498 příplatek ke katalogové ceně zámku + 730 Kč bez další slevy.



		SNI		SNI - broušeno		Cr		Ms		TiN-C		TiN-K		TiN-B	
		cena / pár	EAN	cena / pár	EAN	cena / pár	EAN	cena / pár	EAN	cena / pár	EAN	cena / pár	EAN	cena / pár	EAN
Fábi	Kč €	830,- 35,-	11007			880,- 37,-	11014	880,- 37,-	061550	1340,- 56,-	11021	1340,- 56,-	11038		
Burak	Kč €	750,- 32,-	11243			820,- 35,-	11250	820,- 35,-	061567	1270,- 53,-	11267	1270,- 53,-	11274		
Garanti	Kč €	870,- 37,-	11045			940,- 40,-	11052	940,- 40,-	061574	1380,- 58,-	11069	1380,- 58,-	11076		
Mia	Kč €	750,- 32,-	11281			820,- 35,-	11298	820,- 35,-	061581	1270,- 53,-	11304	1270,- 53,-	11311		
Cesan	Kč €	630,- 27,-	11083			670,- 28,-	11090	670,- 28,-	061598	1140,- 48,-	11106	1140,- 48,-	11113		
Lusy	Kč €	970,- 41,-	11328			1040,- 44,-	11335	1040,- 44,-	061604	1480,- 62,-	11342	1480,- 62,-	11359		
Andy	Kč €	830,- 35,-	11120			880,- 37,-	11137	880,- 37,-	061611	1340,- 56,-	11144	1340,- 56,-	11151		
Deny	Kč €	970,- 41,-	11373			1040,- 44,-	11380	1040,- 44,-	061628	1480,- 62,-	11397	1480,- 62,-	11403		
Kemer	Kč €	920,- 39,-	11168			980,- 41,-	11175	980,- 41,-	061635	1450,- 61,-	11182	1450,- 61,-	11199		
Meclis	Kč €	750,- 32,-	11427			820,- 35,-	11434	820,- 35,-	061642	1270,- 53,-	11441	1270,- 53,-	11458		
Mondeo	Kč €	1220,- 51,-	11205			1290,- 54,-	11212	1290,- 54,-	061659	1720,- 72,-	11229	1720,- 72,-	11236		
Maty	Kč €	990,- 42,-	12646			1080,- 45,-	12653	1080,- 45,-	061666	1540,- 65,-	12660	1540,- 65,-	12677		
Sogut	Kč €	1180,- 50,-	12684			1260,- 53,-	12691	1260,- 53,-	061673	1710,- 72,-	12707	1710,- 72,-	12714		
Cherez	Kč €	1380,- 58,-	12752			1450,- 61,-	12769	1450,- 61,-	061680	1970,- 83,-	12776	1970,- 83,-	12783		
Entero	Kč €	1430,- 60,-	12790	1480,- 62,-	12813	1540,- 65,-	12806	1540,- 65,-	061697	2060,- 86,-	12820	2060,- 86,-	12837	2060,- 86,-	12844
Lara	Kč €			1310,- 55,-	12875	1370,- 58,-	12868	1370,- 58,-	062625	1880,- 79,-	12882	1880,- 79,-	12899		

Kliky - rukojeti jsou připraveny se zvýhodněnou cca 50% slevou oproti klikám s rozetou. Uvedená cena je za pár klik - rukojeti. Všechny typy klik je možné kombinovat se všemi typy zámků (mimo samostatnou kolekci Minimal / Maximal).



Příbuzný sortiment

Klíky a zámky na skleněné dveře



Madla a koule na skleněné  
a dřevěné dveře



Madla dlouhá



## Panty na skleněné dveře

Materiál: masivní mosaz, hliník

Povrchy: SNI, Cr, SNI-broušeno, TiN-C, TiN-B, TiN-K, Ms, Ms-L, Ms-A, Ms-K, K-industrial, zakázkově TiN-A  
více info na [www.kliky-mt.cz/manufaktura/barvy-povrchy](http://www.kliky-mt.cz/manufaktura/barvy-povrchy)

Panty M&T na skleněné dveře doplňují nabídku zámků v designech, které dokonale dotváří jedinečnost interiéru. Pant Trinity a hranatý pant Entero jsou připraveny k zámkům ve všech typech povrchových úprav, což u těchto setů na skleněné dveře představuje jasnou výzvu pro milovníky pokročilého designu.

### Entero **TiN-K** titan černý mat



### Trinity **SNI** matný nikl



#### konstrukční varianty

- pro montáž na tl skla 8-10 mm
- tloušťku skla je potřeba specifikovat
- výkresy vrtání ve specializovaném katalogu M&T GLASS nebo na [www.kliky-mt.cz](http://www.kliky-mt.cz)
- záruka 3 roky, titany 15 let

roky **3 garance** let **15 garance**

Ochranné známky – registrované značky

**ENTERO®**

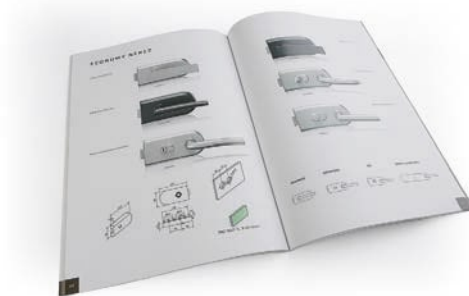
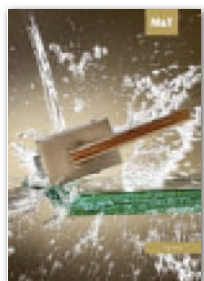
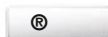

Více informací v kompletním katalogu kování na sklo M&T GLASS



**SNi** matný nikl



**TiN-K** titan černý mat

**Kč** materiál: masivní mosaz povrch: **SNi** matný nikl **EUR**

**Pant Entero**

5290,- Kč  
221,- EUR

5290,-



221,-



**TiN-B** titan braun mat

**Kč** materiál: masivní mosaz povrch: **SNi** matný nikl **EUR**

**Pant Trinity**

6410,- Kč  
268,- EUR

6410,-



268,-



**TiN-B** titan braun mat



**SNi** matný nikl



**TiN-C** titan chrom mat



	SNI		SNI - broušeno		Cr		Ms		TiN-C		TiN-K		TiN-B	
	cena / pár	EAN	cena / pár	EAN	cena / pár	EAN	cena / pár	EAN	cena / pár	EAN	cena / pár	EAN	cena / pár	EAN
Kč €	5290,- 221,-	88184	5290,- 221,-	90439	6390,- 267,-	88160	6390,- 267,-	061888	7770,- 324,-	88207	7770,- 324,-	88191	7770,- 324,-	88214

Součástí pantů a v ceně sady pantů je střední díl pantu a vložka závěsu.



SNI matný nikl - broušeno



Cr lesklý chrom



TiN-C titan chrom mat



	SNI		SNI - broušeno		Cr		Ms		TiN-C		TiN-K		TiN-B	
	cena / pár	EAN	cena / pár	EAN	cena / pár	EAN	cena / pár	EAN	cena / pár	EAN	cena / pár	EAN	cena / pár	EAN
Kč €	6410,- 268,-	88122	6410,- 268,-	90422	7500,- 313,-	88108	7500,- 313,-	061901	8780,- 366,-	88146	8780,- 366,-	88139	8780,- 366,-	88153

Součástí pantů a v ceně sady pantů je střední díl pantu a vložka závěsu.



SNI matný nikl - broušeno



TiN-K titan černý mat



Cr lesklý chrom



Celý projekt - jeden design

Dveřní kliky NEREZ



Nerezové kliky, zámky a panty na skleněné dveře



Mušle na posuvné dveře



Okenní kliky 3 a 4 polohové



Štitové kování NEREZ



Madla dlouhá



Kování pro hliníkové a ocelové dveře, kování na branky



Bezpečnostní rozety



Madla a koule na skleněné a dřevěné dveře



## Nerezové kliky, zámky a panty na skleněné dveře

Materiál: nerezová ocel

Povrchy: NRz, TiN-K, K-industrial

Sety nerezových klik, zámků a pantů M&T doplňují komplexní nabídku nerezového programu vhodného do všech projektů s důrazem na perfektní funkčnost a dlouhodobou životnost. Nadstandardem této řady kování je možnost povlakování žadáným titanovým povrchem v černé barvě TiN-K. V tomto povrchu se jedná o vrcholnou řadu kování vhodnou do špičkových projektů.

Zámek Economy Objekt  
**TiN-K**



Zámek Mini  
**NRz** nerez



Pant Economy Objekt  
**NRz** nerez



Pant Entero  
**NRz** nerez



Varianty provedení

Standard



Standard



Cylindrický



WC



Protikus na dvoukřídlé dveře



konstrukční varianty, materiálové provedení

- pro montáž na tl. skla 8-10 mm
- tloušťku skla je potřeba specifikovat
- výkresy vrtání ve specializovaném katalogu M&T GLASS nebo na [www.kliky-mt.cz](http://www.kliky-mt.cz)
- zámek Economy nerez a Mini nerez je možno kombinovat s jakoukoliv rukojetí nerez z produkce M&T
- záruka 5 let, titany 15 let

5 let **garance**

15 let **garance**

Ochranné známky – registrované značky

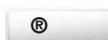

**ENTERO®**  
**MINI®**

Chráněné průmyslové vzory klik



**MORGAN**  
**TECHNO**  
**ENTERO**  
**SENZA**  
**PROMO**  
**NOVA**



Více informací v kompletním katalogu kování na sklo M&T GLASS







NRz nerez - broušeno  
klika Entero

**Zámek Economy Objekt**

9710,- Kč  
405,- EUR

materiál: nerezová ocel  
Kč povrch: NRz nerez - broušeno EUR

9710,-		405,-
9780,-		408,-
10620,-		443,-
10970,-		458,-



TIN-K titan černý mat  
klika Morgan



NRz nerez - broušeno cylindrický  
klika Deny



NRz nerez - broušeno WC  
klika Cesan



		Objekt nerez		Objekt titan		Objekt	
		NRz		TiN-K		K-industrial	
		cena / pár	EAN	cena / pár	EAN	cena / pár	EAN
standard	Kč €	9710,- 405,-	88092	11730,- 489,-	90385	11730,- 489,-	137699
cylindrický	Kč €	9780,- 408,-	90354	11800,- 492,-	90392	11800,- 492,-	137705
WC	Kč €	10620,- 443,-	90361	12630,- 527,-	90408	12630,- 527,-	137712
protikus	Kč €	10970,- 458,-	90378	12960,- 540,-	90415	12960,- 540,-	137729

Cena za set s panty Economy Objekt.

Pro tl. dveří 10 mm jsou v případě potřeby připraveny zámky se sníženou/uzší střílkou o 2 mm... EAN 068498 příplatek ke katalogové ceně zámku + 730 Kč bez další slevy.



NRz nerez - broušeno + protikus  
klíka Lusy

### Pant Economy Objekt



NRz nerez - broušeno



TiN-K titan černý mat



NRz nerez - broušeno  
klika Senza

**Zámek Mini**

6390,- Kč  
267,- EUR

materiál: nerezová ocel  
Kč povrch: NRz nerez - broušeno EUR

6390,-		267,-
7450,-		311,-
7370,-		308,-



TiN-K titan černý mat  
klika Morgan

**Kliky-rukojeti  
k zámkům na sklo**

400,- Kč  
17,- EUR

materiál: nerezová ocel  
Kč povrch: NRz nerez - broušeno EUR

400,-	Lusy	17,-
400,-	Deny	17,-
400,-	Meclis	17,-
590,-	Morgan	25,-
640,-	Jameson	27,-
810,-	Nova	34,-
720,-	Senza	30,-
810,-	Promo	34,-
1030,-	Entero	43,-
810,-	Kvadra	34,-
810,-	Techno	34,-
550,-	Cesan	23,-



NRz nerez - broušeno  
klika Kvadra



NRz nerez - broušeno  
klika Promo



NRz nerez - broušeno  
protikus zámek Mini

		Objekt nerez		Objekt titan		Objekt K-industrial	
		NRz		TiN-K		K-industrial	
		cena / pár	EAN	cena / pár	EAN	cena / pár	EAN
<b>standard</b>	Kč	6390,-	027532	9880,-	027549	9880,-	137736
Cena za set s 2 panty Entero.	€	267,-		412,-		412,-	
<b>WC</b>	Kč	7450,-	080889	10970,-	080896	10970,-	137743
Cena za set s 2 panty Entero.	€	311,-		458,-		458,-	
<b>protikus</b>	Kč	7370,-	066517	10880,-	066524	10880,-	137750
Cena za set s 2 panty Entero.	€	308,-		454,-		454,-	

Pro tl. dveří 10 mm jsou v případě potřeby připraveny zámky se sníženou/užší střílkou o 2 mm... EAN 068498 příplatek ke katalogové ceně zámku + 730 Kč bez další slevy.

		Objekt nerez		Objekt titan		Objekt K-industrial	
		NRz		TiN-K		K-industrial	
		cena / pár	EAN	cena / pár	EAN	cena / pár	EAN
<b>Lusy</b>	Kč	400,-	11366	780,-	90484	780,-	137521
	€	17,-		33,-		33,-	
<b>Deny</b>	Kč	400,-	11410	1110,-	90507	1110,-	137538
	€	17,-		47,-		47,-	
<b>Meclis</b>	Kč	400,-	11465	1260,-	90460	1260,-	137545
	€	17,-		53,-		53,-	
<b>Morgan</b>	Kč	590,-	12745	850,-	90453	850,-	137552
	€	25,-		36,-		36,-	
<b>Jameson</b>	Kč	640,-	91283	1330,-	91290	1330,-	137569
	€	27,-		56,-		56,-	
<b>Nova</b>	Kč	810,-	91306	1490,-	91313	1490,-	137576
	€	34,-		63,-		63,-	
<b>Senza</b>	Kč	720,-	91320			1410,-	137583
	€	30,-				59,-	
<b>Promo</b>	Kč	810,-	91344			1490,-	137590
	€	34,-				63,-	
<b>Entero</b>	Kč	1030,-	12851	1490,-	90491	1490,-	137606
	€	43,-		63,-		63,-	
<b>Kvadra</b>	Kč	810,-	91368	1490,-	91375	1490,-	137613
	€	34,-		63,-		63,-	
<b>Techno</b>	Kč	810,-	91382			1490,-	137620
	€	34,-				63,-	
<b>Cesan</b>	Kč	550,-	15982	1410,-	90477	1410,-	137637
	€	23,-		59,-		59,-	

Kličky - rukojeti jsou připraveny se zvýhodněnou cca 50% slevou oproti klikám s rozetou. Uvedená cena je za pár klik - rukojetí. Všechny typy nerezových klik je možné kombinovat s oběma typy nerezových zámků.

## Pant Entero



NRz nerez - broušeno



TiN-K titan černý mat



Příbuzný sortiment

Mušle Minimal / Maximal  
na skleněné posuvné dveře



Madla dlouhá



Posuvný systém MINIMA  
pro dřevěné a skleněné dveře



## Madla a koule na skleněné a dřevěné dveře

Materiál: masivní mosaz 

Povrchy: SNI, Cr, SNI-broušeno, TiN-C, TiN-B, TiN-K, Ms, Ms-L, zakázkově TiN-A, TiN-S  
více info na [www.kliky-mt.cz/manufaktura/barvy-povrchy](http://www.kliky-mt.cz/manufaktura/barvy-povrchy)

Materiál: nerezová ocel

Povrchy: NRz, TiN-K, K-industrial

Všechny madla a koule M&T na skleněné dveře a dřevěné dveře lze barevnostně a designově sladit s ostatními produkty M&T, což dodává těmto výrobkům naprostou výjimečnost a nezastupitelnost při navrhování kvalitních interiérů.

### Madlo Mimolimit **TiN-K** + dřevina ořech



madla

Minimal, Mimolimit, Maya, Toro, Entry, Entero

### koule Maty **SNI** matný nikl



koule

Maty, Kemer

#### konstrukční varianty, materiálové provedení

- pro montáž na tl. skla 8-12 mm
- tloušťku skla je potřeba specifikovat
- výkresy vrtání ve specializovaném katalogu M&T GLASS nebo na [www.kliky-mt.cz](http://www.kliky-mt.cz)
- pro montáž na dřevěné dveře tl. 37-85 mm
- koule Maty a madla Entero lze dodat i ve variantě NRz
- záruka 3 roky, titany 15 let

roky **3 garance** let **15 garance**

#### Ochranné známky – registrované značky

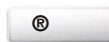

**ENTERO®**  
**MIMOLIMIT®**  
**MINIMAL®**

#### Chráněné průmyslové vzory model



**MIMOLIMIT**  
**MINIMAL**  
**ENTERO**





TiN-K titan černý mat + ořech



SNi matný nikl - broušeno + teak



SNi matný nikl - broušeno



SNi matný nikl - broušeno



TiN-K titan černý mat



SNi matný nikl

**Madlo Mimolimit**

4740,- Kč  
198,- EUR

**Madlo Maya**

4740,- Kč  
198,- EUR

**Madlo Toro**

4570,- Kč  
191,- EUR

**Madlo Entry**

4570,- Kč  
191,- EUR

**Madlo Entero**

4210,- Kč  
176,- EUR

**Madlo Minimal**

4880,- Kč  
204,- EUR

materiál: masivní mosaz  
Kč povrch: SNi matný nikl broušeno EUR

4740,-		198,-
4910,-		205,-
5080,-		212,-
5080,-		212,-

4740,-		198,-
4910,-		205,-
5080,-		212,-
5080,-		212,-

materiál: masivní mosaz  
Kč povrch: SNi matný nikl EUR

4570,-		191,-
4710,-		197,-
4880,-		204,-
4880,-		204,-

4570,-		191,-
4710,-		197,-
4880,-		204,-
4880,-		204,-

4210,-		176,-
4390,-		183,-
4570,-		191,-
4570,-		191,-

4880,-		204,-
5050,-		211,-
5210,-		218,-
5210,-		218,-



		SNI - broušeno		Ms		TiN-C		TiN-K		TiN-B	
		cena / pár	EAN	cena / pár	EAN	cena / pár	EAN	cena / pár	EAN	cena / pár	EAN
tloušťka dveří 37 - 50 mm	Kč €	4740,- 198,-	32040	4800,- 200,-	061925	5730,- 239,-	32088	5730,- 239,-	32125	5730,- 239,-	34174
tloušťka dveří 51 - 68 mm	Kč €	4910,- 205,-	32057	4930,- 206,-	061932	5910,- 247,-	32095	5910,- 247,-	32132	5910,- 247,-	34181
tloušťka dveří 69 - 85 mm	Kč €	5080,- 212,-	32064	5100,- 213,-	061949	6070,- 253,-	32101	6070,- 253,-	32149	6070,- 253,-	34198
tloušťka dveří 8 - 12 mm sklo	Kč €	5080,- 212,-	32071	5100,- 213,-	061956	6070,- 253,-	32118	6070,- 253,-	34167	6070,- 253,-	34204

Cena madla bez dřeva, dřevěná část se objednává samostatně. Tabulka dřevin na str. 93.

tloušťka dveří 37 - 50 mm	Kč €	4740,- 198,-	34211	4800,- 200,-	062007	5730,- 239,-	34259			5730,- 239,-	34297
tloušťka dveří 51 - 68 mm	Kč €	4910,- 205,-	34228	4930,- 206,-	062014	5910,- 247,-	34266			5910,- 247,-	34303
tloušťka dveří 69 - 85 mm	Kč €	5080,- 212,-	34235	5100,- 213,-	062021	6070,- 253,-	34273			6070,- 253,-	34310
tloušťka dveří 8 - 12 mm sklo	Kč €	5080,- 212,-	34242	5100,- 213,-	062038	6070,- 253,-	34280			6070,- 253,-	34327



		SNI		SNI - broušeno		Cr		Ms		TiN-C		TiN-K		TiN-B	
		cena / pár	EAN	cena / pár	EAN	cena / pár	EAN	cena / pár	EAN	cena / pár	EAN	cena / pár	EAN	cena / pár	EAN
tloušťka dveří 37 - 50 mm	Kč €	4570,- 191,-	027990	4590,- 192,-	34334	4590,- 192,-	34372	4590,- 192,-	062083	5580,- 233,-	34426	5580,- 233,-	34495	5580,- 233,-	34501
tloušťka dveří 51 - 68 mm	Kč €	4710,- 197,-	028003	4740,- 198,-	34341	4740,- 198,-	34389	4740,- 198,-	062090	5730,- 239,-	34440	5730,- 239,-	34518	5730,- 239,-	34525
tloušťka dveří 69 - 85 mm	Kč €	4880,- 204,-	028010	4910,- 205,-	34358	4910,- 205,-	34396	4910,- 205,-	062106	5910,- 247,-	34464	5910,- 247,-	34532	5910,- 247,-	34549
tloušťka dveří 8 - 12 mm sklo	Kč €	4880,- 204,-	028027	4910,- 205,-	34365	4910,- 205,-	34402	4910,- 205,-	062113	5910,- 247,-	34488	5910,- 247,-	34556	5910,- 247,-	34563
tloušťka dveří 37 - 50 mm	Kč €	4570,- 191,-	028034	4590,- 192,-	34570	4590,- 192,-	35003	4590,- 192,-	062168	5580,- 233,-	35089	5580,- 233,-	35126	5580,- 233,-	35164
tloušťka dveří 51 - 68 mm	Kč €	4710,- 197,-	028041	4740,- 198,-	34587	4740,- 198,-	35010	4740,- 198,-	062175	5730,- 239,-	35096	5730,- 239,-	35133	5730,- 239,-	35171
tloušťka dveří 69 - 85 mm	Kč €	4880,- 204,-	028058	4910,- 205,-	34594	4910,- 205,-	35027	4910,- 205,-	062182	5910,- 247,-	35102	5910,- 247,-	35140	5910,- 247,-	35188
tloušťka dveří 8 - 12 mm sklo	Kč €	4880,- 204,-	028065	4910,- 205,-	34990	4910,- 205,-	35034	4910,- 205,-	062199	5910,- 247,-	35119	5910,- 247,-	35157	5910,- 247,-	35195
tloušťka dveří 37 - 50 mm	Kč €	4210,- 176,-	028072	4240,- 177,-	69503	4240,- 177,-	69510	4240,- 177,-	062243	5240,- 219,-	69534	5240,- 219,-	69541	5240,- 219,-	69558
tloušťka dveří 51 - 68 mm	Kč €	4390,- 183,-	028089	4410,- 184,-	73975	4410,- 184,-	73999	4410,- 184,-	062250	5400,- 225,-	74033	5400,- 225,-	74057	5400,- 225,-	74071
tloušťka dveří 69 - 85 mm	Kč €	4570,- 191,-	028096	4590,- 192,-	73982	4590,- 192,-	74002	4590,- 192,-	062267	5580,- 233,-	74040	5580,- 233,-	74064	5580,- 233,-	74088
tloušťka dveří 8 - 12 mm sklo	Kč €	4570,- 191,-	028102	4590,- 192,-	35201	4590,- 192,-	35218	4590,- 192,-	062274	5580,- 233,-	35232	5580,- 233,-	35249	5580,- 233,-	35256
tloušťka dveří 38 - 50 mm	Kč €	4880,- 204,-	028119	4910,- 205,-	028157	4910,- 205,-	028195	4910,- 205,-	062328	5910,- 247,-	028270	5910,- 247,-	028317	5910,- 247,-	028355
tloušťka dveří 51 - 68 mm	Kč €	5050,- 211,-	028126	5080,- 212,-	028164	5080,- 212,-	028201	5080,- 212,-	062335	6070,- 253,-	028287	6070,- 253,-	028324	6070,- 253,-	028362
tloušťka dveří 69 - 85 mm	Kč €	5210,- 218,-	028133	5240,- 219,-	028171	5240,- 219,-	028218	5240,- 219,-	062342	6230,- 260,-	028294	6230,- 260,-	028331	6230,- 260,-	028379
tloušťka dveří 8 - 12 mm sklo	Kč €	5210,- 218,-	028140	5240,- 219,-	028188	5240,- 219,-	028225	5240,- 219,-	062359	6230,- 260,-	028300	6230,- 260,-	028348	6230,- 260,-	028386

Všechny varianty madel jsou pevné neotočné. Zakázkově lze připravit variantu s otočným madlem Entero.





SNi matný nikl



TiN-K titan černý mat

### Koule Maty

2220,- Kč  
93,- EUR

KČ	materiál: masivní mosaz povrch: SNi matný nikl	EUR
2220,-		93,-
2400,-		100,-
2550,-		107,-
2550,-		107,-





Cr lesklý chrom



SNi matný nikl

### Koule Kemer

1880,- Kč  
79,- EUR

KČ	materiál: masivní mosaz povrch: SNi matný nikl	EUR
1880,-		79,-
2060,-		86,-
2220,-		93,-
2220,-		93,-

Povrchy Ms-L, TiN-A, TiN-S – více na [www.kliky-mt.cz/katalog](http://www.kliky-mt.cz/katalog)





NRz nerez - broušeno



TiN-K titan černý mat

### Koule Maty

2080,- Kč  
87,- EUR

KČ	materiál: nerezová ocel povrch: NRz nerez - broušeno	EUR
2080,-		87,-
2250,-		94,-
2410,-		101,-
2410,-		101,-



NRz nerez - broušeno

### Madlo Entero

4000,- Kč  
167,- EUR

KČ	materiál: nerezová ocel povrch: NRz nerez - broušeno	EUR
4000,-		167,-
4160,-		174,-
4320,-		180,-
4320,-		180,-





		SNI		Cr		Ms		TiN-C		TiN-K	
		cena / pár	EAN	cena / pár	EAN	cena / pár	EAN	cena / pár	EAN	cena / pár	EAN
tloušťka dveří 37 - 50 mm	Kč €	2220,- 93,-	20283	2220,- 93,-	20290	2220,- 93,-	062403	3210,- 134,-	20689	3210,- 134,-	20696
tloušťka dveří 51 - 68 mm	Kč €	2400,- 100,-	73616	2400,- 100,-	73630	2400,- 100,-	062410	3390,- 142,-	73678	3390,- 142,-	73692
tloušťka dveří 69 - 85 mm	Kč €	2550,- 107,-	73623	2550,- 107,-	73647	2550,- 107,-	062427	3530,- 148,-	73685	3530,- 148,-	73708
tloušťka dveří 8 - 12 mm sklo	Kč €	2550,- 107,-	28586	2550,- 107,-	28593	2550,- 107,-	062434	3530,- 148,-	28616	3530,- 148,-	28623

Koule Maty na magnetických rozetách + 380 Kč příplatek.



		SNI		Cr		Ms		TiN-C		TiN-K	
		cena / pár	EAN	cena / pár	EAN	cena / pár	EAN	cena / pár	EAN	cena / pár	EAN
tloušťka dveří 37 - 50 mm	Kč €	1880,- 79,-	42698	1880,- 79,-	42704	1880,- 79,-	062489	2890,- 121,-	42728	2890,- 121,-	42735
tloušťka dveří 51 - 68 mm	Kč €	2060,- 86,-	73852	2060,- 86,-	73876	2060,- 86,-	062496	3050,- 128,-	73913	3050,- 128,-	73937
tloušťka dveří 69 - 85 mm	Kč €	2220,- 93,-	73869	2220,- 93,-	73883	2220,- 93,-	062502	3210,- 134,-	73920	3210,- 134,-	73944
tloušťka dveří 8 - 12 mm sklo	Kč €	2220,- 93,-	30237	2220,- 93,-	30244	2220,- 93,-	062519	3210,- 134,-	30978	3210,- 134,-	30985

		NRz		TiN-K		K-industrial	
		cena / pár	EAN	cena / pár	EAN	cena / pár	EAN
tloušťka dveří 37 - 50 mm	Kč €	2080,- 87,-	024982	3030,- 127,-	025026	3030,- 127,-	034486
tloušťka dveří 51 - 68 mm	Kč €	2250,- 94,-	024999	3180,- 133,-	025033	3180,- 133,-	034493
tloušťka dveří 69 - 85 mm	Kč €	2410,- 101,-	025002	3330,- 139,-	025040	3330,- 139,-	034509
tloušťka dveří 8 - 12 mm sklo	Kč €	2410,- 101,-	025019	3330,- 139,-	025057	3330,- 139,-	034516

Koule Maty na magnetických rozetách + 380 Kč příplatek.

		NRz		TiN-K		K-industrial	
		cena / pár	EAN	cena / pár	EAN	cena / pár	EAN
tloušťka dveří 37 - 50 mm	Kč €	4000,- 167,-	025064	4930,- 206,-	025101	4930,- 206,-	034523
tloušťka dveří 51 - 68 mm	Kč €	4160,- 174,-	025071	5090,- 213,-	025118	5090,- 213,-	034530
tloušťka dveří 69 - 85 mm	Kč €	4320,- 180,-	025088	5260,- 220,-	025125	5260,- 220,-	034547
tloušťka dveří 8 - 12 mm sklo	Kč €	4320,- 180,-	025095	5260,- 220,-	025132	5260,- 220,-	034554

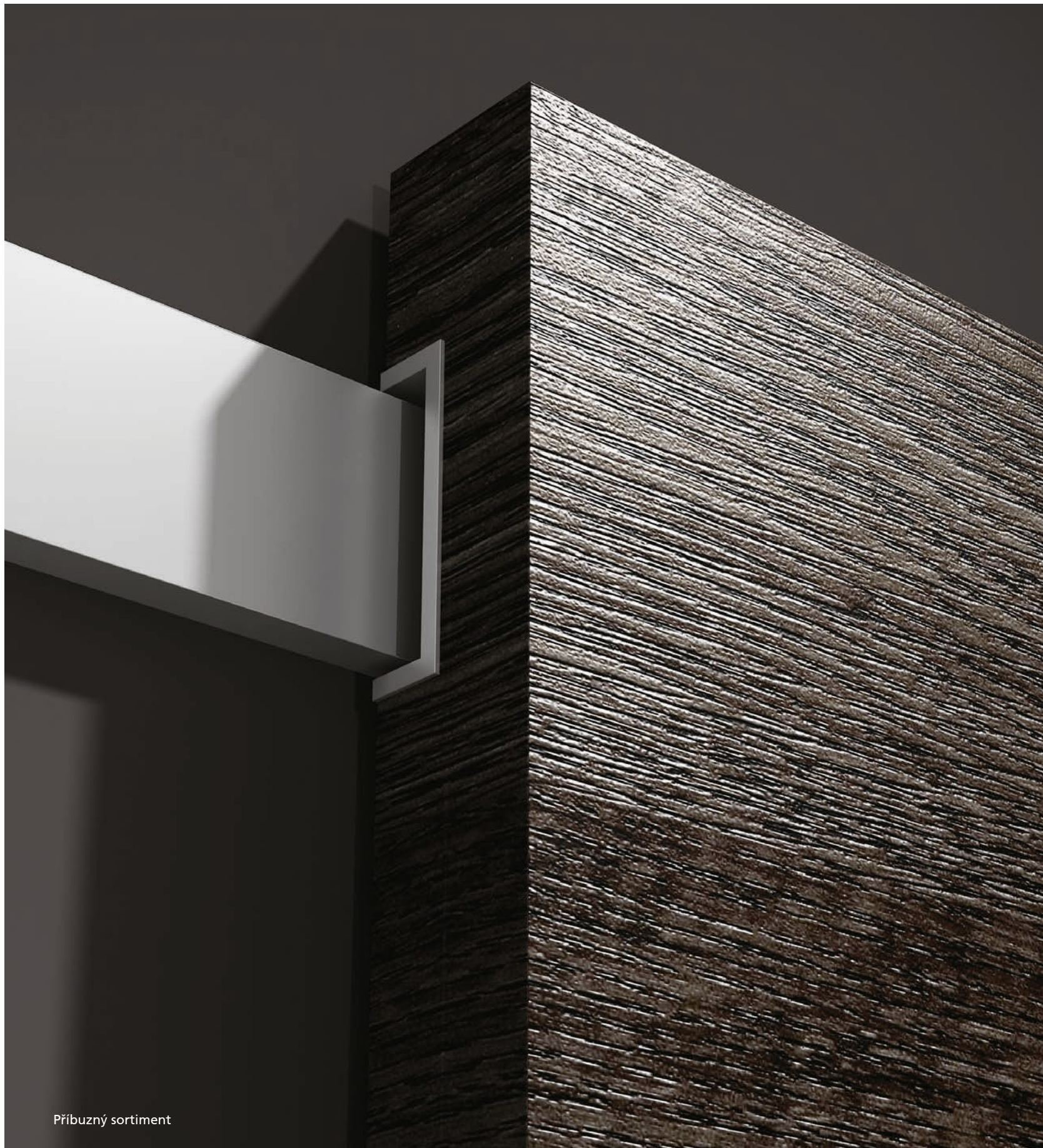

Příbuzný sortiment

Mušle Minimal / Maximal  
na skleněné posuvné dveře



Madla a koule na skleněné  
a dřevěné dveře



Mušle na posuvné dveře



Madla dlouhá



## Posuvný systém MINIMA 2.0 pro dřevěné a skleněné dveře

Materiál: hliník

Povrchy: stříbrný matný hliník, černý mat

Posuvný systém MINIMA 2.0 je inovativní svým řešením s perfektní funkčností a nepřehlédnutelným čistým designem, navazující na svého předchůdce posuv Minima. Posuv je konstruován s integrovaným zpomalovacím a tlumícím systémem při dojezdu v obou směrech. Vhodným doplňkem jsou ovládací mušle Minimal 2.0 vždy v barevném odstínu jako je posuv Minima. Perfektní volbou na skleněné dveře k posuvnému systému Minima je madlo Mimolimit, které v kombinaci masivní dřevo + sklo působí neopakovatelně. Výbornou volbou je také madlo Yes!

### MINIMA 2.0 na dřevěné dveře



### MINIMA 2.0 na skleněné dveře

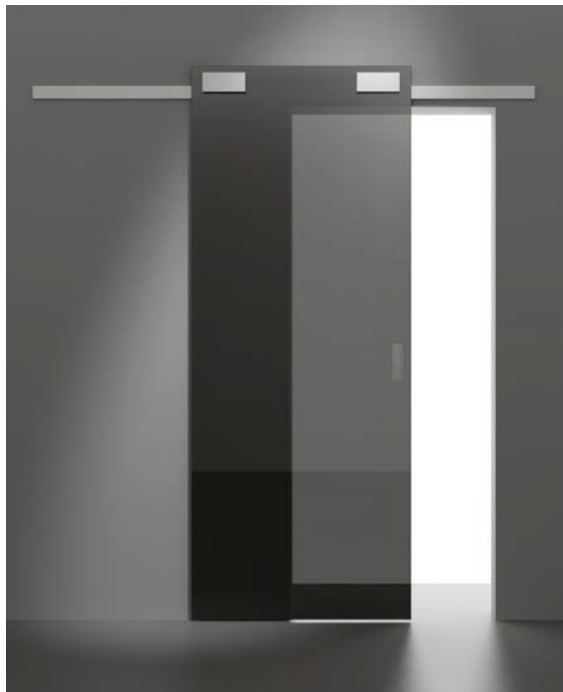

#### konstrukční varianty, materiálové provedení

- konstrukčně a montážně připraveno pro dveřní křídla do hmotnosti 80 kg
- univerzální systém pro dřevěné a skleněné dveře
- délky lišt 1700, 2000, 3000, 4000 a 6000 mm
- 2 varianty barevného provedení
- ovládací mušle a madla v identickém barevném provedení
- individuální rozměry délek lišt na základě požadavku
- záruka 3 roky

roky **3** garance

Ochranné známky – registrované značky

MINIMA®

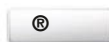

Patent



integrovaný zpomalovací a tlumící systém při dojezdu dveřního křídla v obou směrech

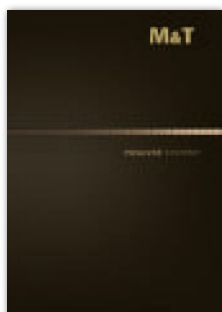

**Minima 2.0 pro dřevěné dveře**



posuv **černý mat**  
mušle Minimal **TiN-K** titan černý mat



posuv **černý mat**  
madlo Minimal **TiN-K** titan černý mat



posuv **stříbrný matný hliník**  
mušle Minimal **SNi** matný nikel

**Pojezdová nosná lišta**

2200,- Kč  
92,- EUR

**Kč** materiál: hliník povrch: stříbrný matný hliník **EUR**

2200,- 92,-

2420,- 101,-

3450,- 144,-

4290,- 179,-

5970,- 249,-

**Krycí lišta**

1890,- Kč  
79,- EUR

1890,- 79,-

2160,- 90,-

3350,- 140,-

4320,- 180,-

6270,- 262,-

**Kč** **EUR**

**Minima sada s tlumiči**

4500,- Kč  
188,- EUR

4500,- 188,-

**Spodní vodící lišta**

310,- Kč  
13,- EUR

**Kč** povrch: stříbrný TPE polymer **EUR**

310,- 13,-

	Stříbr. matný hliník			Černý mat	
		cena / ks	EAN	cena / ks	EAN
1700 mm	Kč €	2200,- 92,-	153217	2650,- 111,-	153262
2000 mm	Kč €	2420,- 101,-	153224	2890,- 121,-	153279
3000 mm	Kč €	3450,- 144,-	153231	3910,- 163,-	153286
4000 mm	Kč €	4290,- 179,-	153248	4730,- 198,-	153293
6000 mm	Kč €	5970,- 249,-	153255	6870,- 287,-	153309
1700 mm	Kč €	1890,- 79,-	153316	2650,- 111,-	153361
2000 mm	Kč €	2160,- 90,-	153323	2910,- 122,-	153378
3000 mm	Kč €	3350,- 140,-	153330	4110,- 172,-	153385
4000 mm	Kč €	4320,- 180,-	153347	5070,- 212,-	153392
6000 mm	Kč €	6270,- 262,-	153354	7760,- 324,-	153408

		cena / ks	EAN
80 kg pro dřevěné dveře	Kč €	4500,- 188,-	153422

	Stříbrný TPE polymer		
		cena / ks	EAN
1000 mm	Kč €	310,- 13,-	153439

Posuvný systém pro dveře se skládá z pojezdové nosné lišty + krycí lišty + sady s tlumiči a příslušenstvím. Z těchto tří komponentů se sestavuje kompletní posuv Minima. Pojezdová nosná lišta a krycí lišta jsou univerzální pro oba systémy, sada s tlumiči je odlišná pro dřevěné a skleněné dveře.

**Pozor! Posuvný systém Minima je nahrazen novou verzí Minima 2.0. Zároveň postupně dochází k doprodeji dosavadního posuvu Minima. O dostupnosti posuvu Minima se informujte vždy před objednáním.**



posuv **černý mat**  
madlo Mimolimit **TiN-K** titan černý mat + teak

**Minima 2.0 glass**

**Pojezdová nosná lišta**

2200,- Kč  
92,- EUR

**Krycí lišta**

1890,- Kč  
79,- EUR

**Minima glass sada s tlumiči**

6170,- Kč  
258,- EUR

**KČ** materiál: hliník povrch: stříbrný matný hliník **EUR**

2200,- 92,-

2420,- 101,-

3450,- 144,-

4290,- 179,-

5970,- 249,-

1890,- 79,-

2160,- 90,-

3350,- 140,-

4320,- 180,-

6270,- 262,-

**KČ** povrch: stříbrný matný hliník **EUR**

6170,- 258,-



posuv **stříbrný matný hliník**  
mušle Minimal **SNi** matný nikel

	Stříbr. matný hliník			Černý mat	
	cena / ks	EAN	cena / ks	EAN	
1700 mm	Kč €	2200,- 92,-	153217	2650,- 111,-	153262
2000 mm	Kč €	2420,- 101,-	153224	2890,- 121,-	153279
3000 mm	Kč €	3450,- 144,-	153231	3910,- 163,-	153286
4000 mm	Kč €	4290,- 179,-	153248	4730,- 198,-	153293
6000 mm	Kč €	5970,- 249,-	153255	6870,- 287,-	153309

1700 mm	Kč €	1890,- 79,-	153316	2650,- 111,-	153361
2000 mm	Kč €	2160,- 90,-	153323	2910,- 122,-	153378
3000 mm	Kč €	3350,- 140,-	153330	4110,- 172,-	153385
4000 mm	Kč €	4320,- 180,-	153347	5070,- 212,-	153392
6000 mm	Kč €	6270,- 262,-	153354	7760,- 324,-	153408

	Stříbr. matný hliník			Černý mat	
	cena / ks	EAN	cena / ks	EAN	
80 kg pro skleněné dveře	Kč €	6170,- 258,-	153453	6620,- 276,-	153446

Posuvný systém pro dveře se skládá z pojezdové nosné lišty + krycí lišty + sady s tlumiči a příslušenstvím. Z těchto tří komponentů se sestavuje kompletní posuv Minima. Součástí sady je i stavitelný vodící blok. K posuvnému systému doporučujeme mušle Minimal / Maximal v identické barvě povrchu jako je posuv.



posuv **Minima Glass** povrch černá mat

**Pozor! Posuvný systém Minima je nahrazen novou verzí Minima 2.0. Zároveň postupně dochází k doprodeji dosavadního posuvu Minima. O dostupnosti posuvu Minima se informujte vždy před objednáním.**

**Systém pro dřevěné dveře  
Minima 2.0**

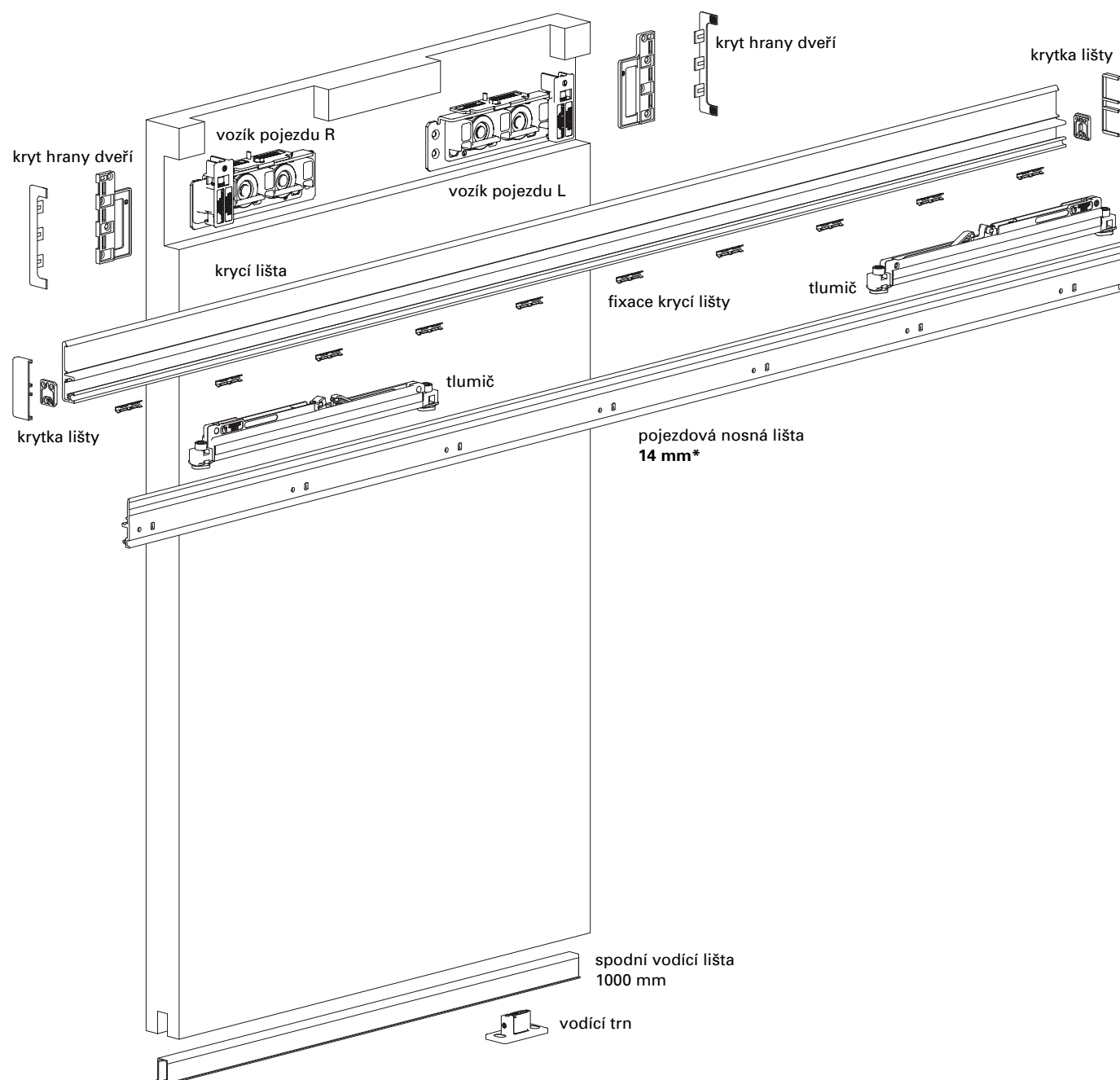

**\* rozměr 14 mm**

- je odsazení desky dveřního křídla od stěny
- po montáži na pojezdovou nosnou lištu

**vše ve stejném povrchu**

- krycí lišta
- pojezdová nosná lišta
- kryt hrany dveří
- krytka lišty

**délky lišt**

- 1700 mm
- 2000 mm
- 3000 mm
- 4000 mm
- 6000 mm

individuálně možnost jiného rozměru

**tlumič**

- pro dveře max. 80 kg

**povrchy - barvy**

- stříbrný matný hliník
- černý mat



**System pro skleněné dveře**  
**Minima 2.0 glass**

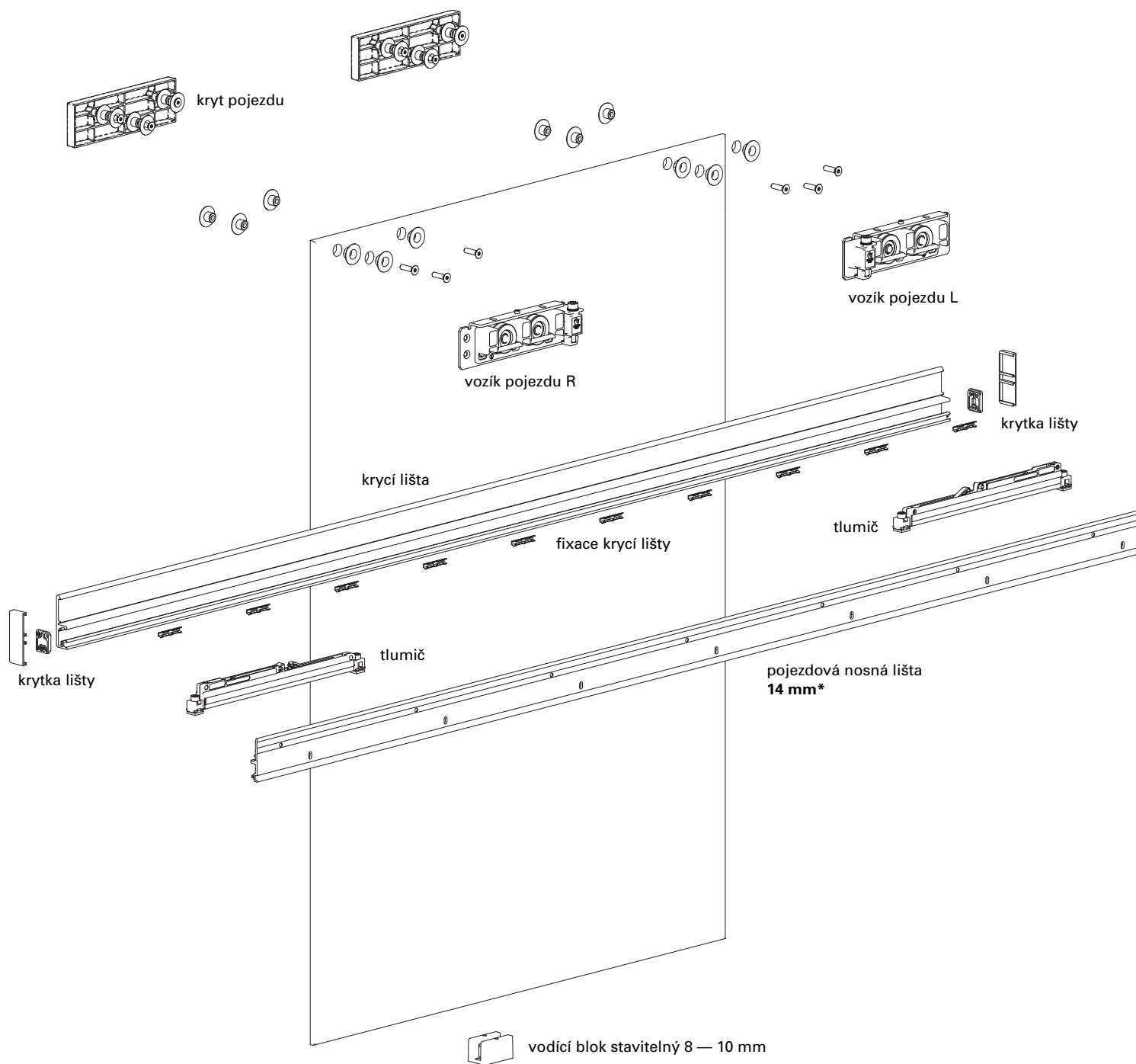

**vše ve stejném povrchu**

- kryt pojezdu
- krytka lišty
- krycí lišta
- pojezdová nosná lišta
- vodící blok

**délky lišt**

- 1700 mm
- 2000 mm
- 3000 mm
- 4000 mm

individuálně možnost jiného rozměru

**tlumič**

- pro dveře max. 80 kg

**povrchy - barvy**

- stříbrný matný hliník
- černý mat



Příbuzný sortiment

Systém Magnetic



reddot winner 2020

Ovládací madla Magnetic



Magnetické zámky



Dveřní kliky



Zapuštěné soklové lišty



## Neviditelné zárubně a sokly MINIMA

Vyvinuli jsme kompletní dveřní systém pro minimalistické interiéry – neviditelné zárubně MINIMA. Zásadní předností je komplexnost řešení. Rozměrově lze zárubně využít bez jakýchkoliv omezení do výšky 4000 mm. Pro technické prostory a objekty se zvýšenými požadavky jsou zárubně připraveny s certifikací požární odolnosti, akustickou a bezpečnostní odolností, s návazností na obklady okolních stěn a systémové zapuštěné podlahové lišty. Připraveno pro systém Magnetic.

Testováno ve vlastní robotické zkušebně na 40 let provozu.

Tento produkt je určen pouze pro partnery - smluvní výrobce dveří a není samostatně v prodeji. Každá zárubeň je vyráběna zakázkově v požadovaném rozměru, objednávaná přes clientské rozhraní, expedována s identifikací zadanou partnerem tj. místem určení, rozměrem, pozicí na stavbě, označením místnosti popř. dalšími požadovanými informacemi. Dodávána včetně všech důležitých montážních komponentů (perlinka, pružná stěrková hmota, lepidlo, hmoždinky, vruty), s kvalitním teflonovým těsněním.

**Materiál: hliník**

**Povrchy: černý mat, přírodní povrch bez eloxu**

### Minima 40

pro dveře tl. 40 mm varianty Classic a Revers



### Minima 60

pro dveře tl. 60 mm Classic a Revers



součástí zárubně je:

- nacvakávací lišta s armovací tkaninou pro napojení na ostatní stavební materiály (sádkartón, zdivo)
- pružná stěrková hmota Hard & Elastic s jedinečnými vlastnostmi zabráňujícími popraskání zdiva kolem zárubně (testováno se všemi druhy běžného zdiva)
- teflonové těsnění s výběrem 7 odstínů
- konstrukce s dutým U profilem pro vložení materiálu povrchové a barevně shodného s dveřmi
- Neviditelné zárubně Minima jsou prakticky neviditelné i při otevřených dveřích
- i po osazení zárubně lze měnit orientaci dveří L x P
- připraveno pro systém Magnetic
- zárubně vyráběny ve dvou provedeních tj. černá matná a přírodní hliník pro možnost nátěru

další speciální výhody zárubně Minima 60:

- požární odolnost 60 min do rozměru dveří 1050x2750, při tl. dveří 60 mm
- akustická odolnost
- bezpečnostní odolnost
- návaznost na okolní obložení zdiva až do tl. 12 mm (např. obklady koupelen)
- návaznost na systémovou zapuštěnou soklovou lištu Soclick
- u zárubně se nerozlišuje levé a pravé provedení

Pro dokonale hladký celek doporučujeme neviditelné zárubně doplnit systémem Soclick pro zapuštěné soklové lišty. Oba systémy se osazují do stavby současně. V případě kombinace zárubní a skrytých soklových lišt POZOR, u zárubní C40 a R40 je v rámci objednávky nutno specifikovat úpravu pro napojení soklových lišt.

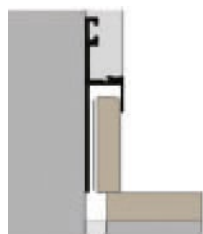

**Soclick Projekt**, profil s absencí detailu viditelné stínové spáry.

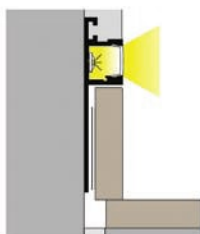

**Soclick LED**, inovovaná soklová lišta pro LED pásy, s kvalitními difuzory.

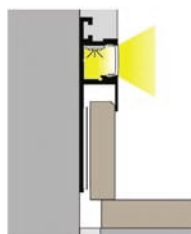

**Soclick LED Projekt**, stejné vlastnosti jako Soclick LED s absencí stínové spáry.

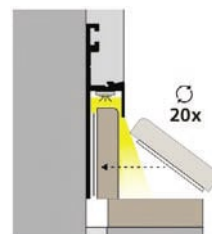

**Soclick Projekt** umožňuje opakovaný přístup k elektronickým součástkám.

## Konstrukce

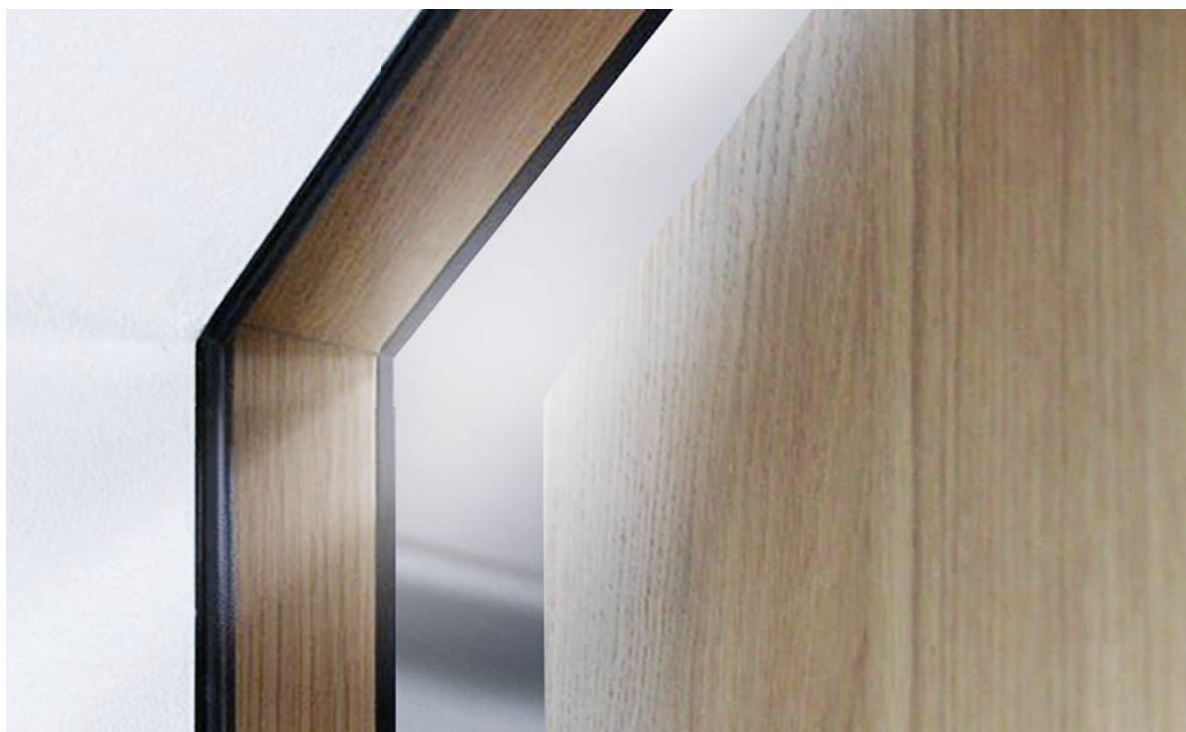

Patentovaná konstrukce zárubně, kdy se do hliníkové komory vkládá dřevěná vložka vyrobená podle požadavků na celkový design, tzn. s možností materiálové a barevné volby pro efekt neviditelné zárubně i při otevřených dveřích.

## Design



Společně s dveřním kováním Maximal Ize dosáhnout úplného sladění s dveřmi a zárubní

## Systemové řešení



Konstrukce je vybavena systémovou nacvakávací lištou s armovací tkaninou a stěrkovou elastickou hmotou Hard & Elastic zabráňující popraskání zdiva kolem zárubně.

## Technické přednosti

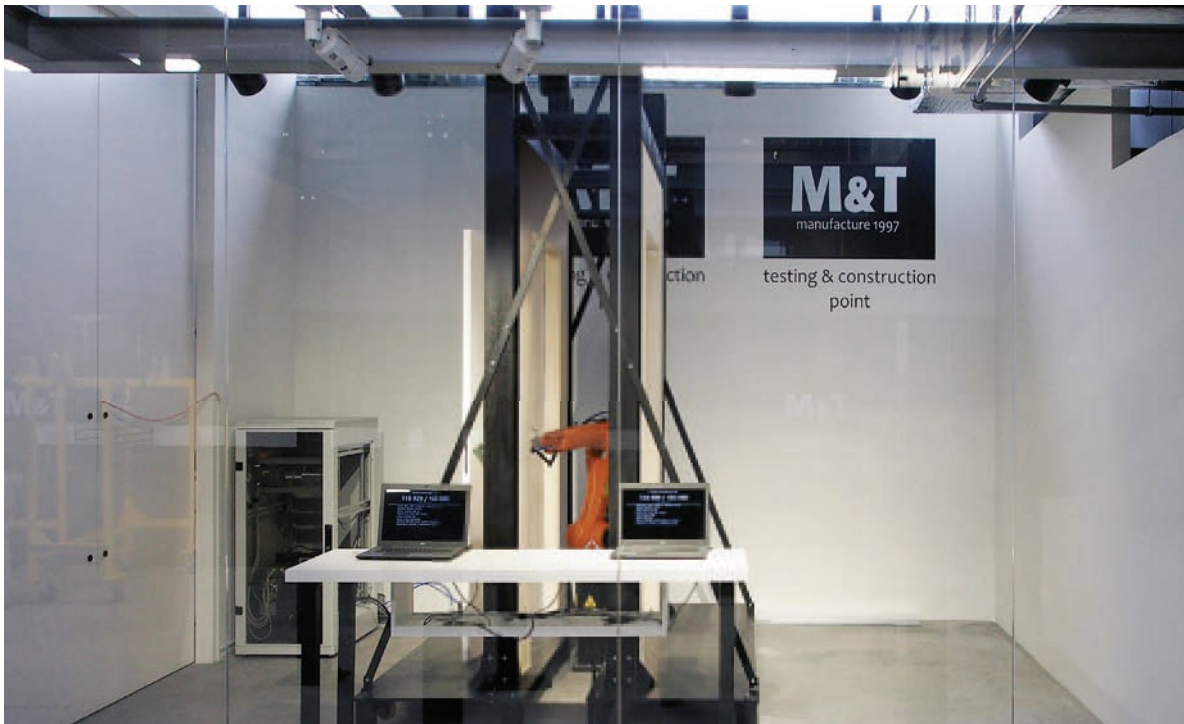

Zásadní je perfektní funkčnost celého systému. Proto jsme 8 měsíců testovali veškeré komponenty v různých podmínkách, se zárubní zabudovanou v různých typech zdiva, celkem přes 600.000 cyklů.



Soclick LED pro materiály do tloušťky až ~ 12,5 mm včetně lepidla

- výplň soklu o tloušťce až 12,5 mm s libovolnou výškou
- profil s komorou pro LED pásky, včetně difuzoru
- použitím dalších stavebnicových prvků je možné dosáhnout pestrých materiálových, ale i funkčních kombinací



Nosný profil 65 mm pro materiály do tloušťky až ~ 11,5 mm včetně lepidla

- flexibilní provedení umožňuje soklování zaoblených stěn i schodišť
- přímé schodové dílce pro přesnou a efektivní montáž

## K zárubním připraveny komponenty a systém skrytých soklů Soclick

3D panty stříbrné, černé, bílé Simonswerk Tectus 240. 340

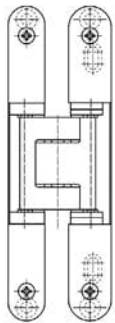

pant Tectus 240

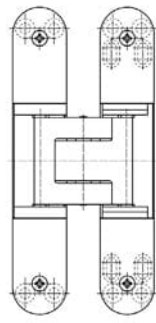

pant Tectus 340

Nápinák/ vyrovnavač dveří M&T ..  
stavebnicová konstrukce  
pro délky 1970 – 3000 mm

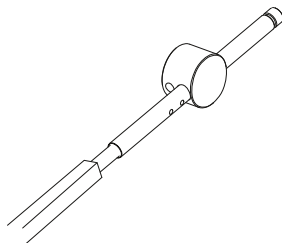

Padací lišty se zpožděním,  
protipožární lišty

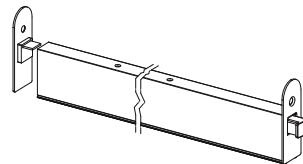

Protipožární teplotní zajišťovač  
dveří Firebold

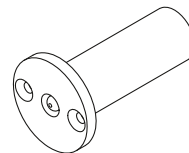

Magnetické zámky s protiplechy stříbrné, černé, bílé

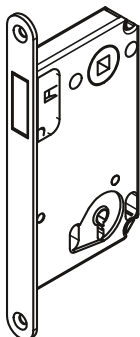

magnetický zámek  
dozický

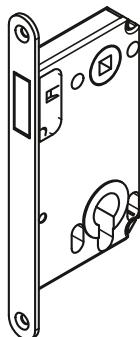

magnetický zámek  
cylindrický

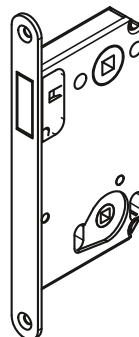

magnetický zámek  
WC

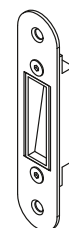

seřiditelný protiplech

Ucelený systém skrytých soklů



Nosný profil 65 mm



Soclick Projekt

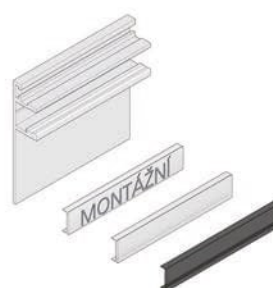

Soclick LED



Soclick LED Projekt



Napojení na skryté zárubně



Schodišťové dílce

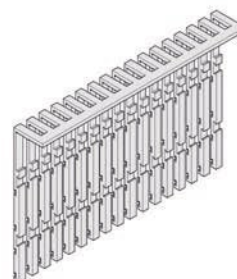

Flexibilní provedení pro obloukové stěny

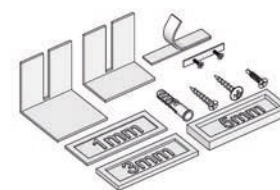

Montážní materiál s možností  
SNADNO DEMONTOVATELNÉ  
VÝPLNĚ soklové lišty

Více na [www.neviditelny-sokl.cz](http://www.neviditelny-sokl.cz)



Příbuzný sortiment

Dveřní kliky NEREZ



Dveřní kliky DESIGN 2000, 2004



Dveřní kliky DESIGN 2006



Dveřní kliky DESIGN 2009



Dveřní kliky DESIGN 2011  
řada MINI



Dveřní kliky DESIGN 2012  
ploché rozety



Dveřní kliky DESIGN 2012  
zapuštěné rozety



Dveřní kliky a kování DESIGN 2013  
řada MINIMAL/MAXIMAL





## Magnetické zámky

Povrchy: **broušený chrom Cr - broušeno, lesklý chrom Cr, černý K, stříbrný matný STř, bílý Wh**

Magnetické zámky přinášejí uživatelský komfort při obsluze dveří. Magnetické zámky M&T jsou konstrukčně připraveny jak pro polodrážkové/falcové, tak bezfalcové dveře. Vítanou inovací je seřiditelný protiplech pro bezfalcové dveře. Předností je barevnostní nabídka povrchů zámků, která koresponduje s povrchy dveřních klik. Zámky jsou připraveny ve všech variantách zamykání.

### Magnetický zámeček

Standard



### Protiplech

seřiditelný do stran

24 mm

22 mm



konstrukční varianty, materiálové provedení

- stejný rozměr a zádlab do dveří pro zámeček standard
- zavírání dveří bez použití kliky ... stačí pouze do dveří strčit a dveře se přesně dovřou
- bezchybná funkce střešky zámku ... zámeček je vysoce spolehlivý, bez možnosti zablokování dveří
- povrchy broušený chrom, lesklý chrom, černý matný, stříbrný matný, bílý
- garantovaná životnost 150 000 cyklů
- nabízené zámky jsou zámky interiérové, mezipokojevé - nevhodné pro vstupní dveře do objektů
- lze dodat i magnetické zámky do zátěžového prostředí

Doporučené použití při montáži kování

Po vrtání otvorů pro rozetové kování PROFÍ šablonou M&T skrze dveře, vyjměte zámeček ze dveří. Zámeček vyčistěte od dřevěných pilin a čistý namontujte zpět do dveří. Dřevěné piliny mohou mít za následek nepřesnou funkci zámku a klik. Zámeček nemazat tuky, které „zalepí“ zámeček.





Cr lesklý chrom dozický



K černý matný WC

**Zámek Standard**

440,- Kč  
19,- EUR



Cr - broušeno broušený chrom cylindrický

**Kč**    povrch: Cr chrom broušeno    **EUR**

440,-		19,-
440,-		19,-
440,-		19,-



**Seřiditelný protiplech 24 mm  
magnet**

290,- Kč  
13,- EUR

**Kč**    povrch: Cr chrom broušeno    **EUR**

290,-		13,-
-------	--	------

**Seřiditelný protiplech 22 mm  
magnet**

320,- Kč  
14,- EUR

**Kč**    povrch: Cr chrom broušeno    **EUR**

320,-		14,-
-------	--	------

		Cr - broušeno		Cr lesklý chrom		K černý matný		STř stříbrný matný		Wh bílý	
		cena / ks	EAN	cena / ks	EAN	cena / ks	EAN	cena / ks	EAN	cena / ks	EAN
dozický	Kč €	440,- 19,-	49307	440,- 19,-	49390	510,- 22,-	080902	400,- 17,-	080933	510,- 22,-	080964
cyklindrický	Kč €	440,- 19,-	49314	440,- 19,-	49406	510,- 22,-	080919	400,- 17,-	080940	510,- 22,-	080971
WC	Kč €	440,- 19,-	49383	440,- 19,-	49420	510,- 22,-	080926	400,- 17,-	080957	510,- 22,-	080988

Uváděné zámky jsou zámky interiérové, mezipokojové - nevhodné pro vstupní dveře do objektů.  
Cylindrické zámky nelze použít ke kombinaci koule/klika.

		Cr - broušeno		Cr lesklý chrom		K černý matný		STř stříbrný matný		Wh bílý	
		cena / ks	EAN	cena / ks	EAN	cena / ks	EAN	cena / ks	EAN	cena / ks	EAN
	Kč €	290,- 13,-	49192	290,- 13,-	49208	380,- 16,-	080995	290,- 13,-	081008	380,- 16,-	081015

Seřiditelný protiplech lze použít pouze na bezfalcové dveře. Šířka protiplechu je 24 mm. Seřízení do stran  $\pm 1$  mm.

		Cr - broušeno		Cr lesklý chrom		K černý matný		STř stříbrný matný		Wh bílý	
		cena / ks	EAN	cena / ks	EAN	cena / ks	EAN	cena / ks	EAN	cena / ks	EAN
	Kč €	320,- 14,-	086522	320,- 14,-	086515	320,- 14,-	081022	260,- 11,-	081039	320,- 14,-	081046

Seřiditelný protiplech lze použít pouze na bezfalcové dveře. Šířka protiplechu je 22 mm. Seřízení do stran  $\pm 1,5$  mm.



Příbuzný sortiment



Dveřní kliky NEREZ



Dveřní kliky DESIGN 2000, 2004



Dveřní kliky DESIGN 2006



Dveřní kliky DESIGN 2009



Dveřní kliky DESIGN 2011  
řada MINI



Dveřní kliky DESIGN 2012  
ploché rozety



Dveřní kliky DESIGN 2012  
zapuštěné rozety



Dveřní kliky a kování DESIGN 2013  
řada MINIMAL/MAXIMAL



## Panty na dřevěné dveře

Materiál: ocel  
Povrchy: SNI, Cr, TiN-K

Minimalistické hranaté panty jsou ideálním doplňkem dveří k hranatým klikám. Tento příznaný detail dodává dveřím koncepčnost a vyšší užitnou hodnotu. Pro oblíbené černé kliky je v nabídce také kulatý černý pant pro sladění interiéru.

MINI **SNI** matný nikl



MINI **TiN-K** titan černý mat



KULATÝ **TiN-K** titan černý mat



### konstrukční varianty

- doporučená nosnost pantů Mini .. 2 ks do hmotnosti dveřního křídla 40 kg
- panty jsou konstrukčně řešeny pro snadnou montáž na dveřní křídlo, stejně jako používané standardní panty
- záruka 3 roky, titany 15 let

roky **3 garance** let **15 garance**

Ochranné známky – registrované značky

MINI®





SNi matný nikel



Cr lesklý chrom



TiN-K titan černý mat

**Pant Mini**

430,- Kč  
18,- EUR

Kč	materiál: ocel povrch: SNI matný nikel	EUR
430,-		18,-
430,-		18,-



TiN-K titan černý mat

**Kulatý pant**

250,- Kč  
11,- EUR

Kč	materiál: ocel povrch: TiN-K titan černý mat	EUR
250,-		11,-



SNi matný nikel



Cr lesklý chrom

**Krytka pantu**

190,- Kč  
8,- EUR

Kč	materiál: masivní mosaz povrch: SNI matný nikel	EUR
190,-		8,-



TiN-S titan bronz mat

		Sni		Cr		TiN-K	
		cena / ks	EAN	cena / ks	EAN	cena / ks	EAN
pravý R	Kč €	430,- 18,-	86999	580,- 25,-	87019	720,- 30,-	87033
levý L	Kč €	430,- 18,-	87002	580,- 25,-	87026	720,- 30,-	87040

		TiN-K	
		cena / ks	EAN
	Kč €	250,- 11,-	070569

		Sni		Cr		Ms		Ms-L		TiN-C		TiN-K		TiN-B		TiN-A	
		cena	EAN	cena	EAN	cena	EAN	cena	EAN	cena	EAN	cena	EAN	cena	EAN	cena	EAN
		pár		pár		pár		pár		pár		pár		pár		pár	
Ø 15 mm dl. 48 mm	Kč €	190,- 8,-	72985	190,- 8,-	72992	470,- 20,-	062564	470,- 20,-	062571	400,- 17,-	73012	400,- 17,-	73029	400,- 17,-	91962	400,- 17,-	73036

Krytka je připravena ke standardním pantům TKZ Trio průměr 15 mm. Povrch TiN-A je matný, **nebroušený**.



TiN-C titan chrom mat



TiN-B titan braun mat



TiN-A titan mosaz mat



TiN-K titan černý mat



Příbuzný sortiment

Dveřní kliky NEREZ



Dveřní kliky DESIGN 2000, 2004



Dveřní kliky DESIGN 2006



Dveřní kliky DESIGN 2009



Dveřní kliky DESIGN 2011  
řada MINI



Dveřní kliky DESIGN 2017  
magnetické rozety



Dveřní kliky NEREZ + magnetické rozety



Dveřní kliky a kování DESIGN 2013  
řada MINIMAL/MAXIMAL





## Dveřní zarážky

Materiál: ocel, mosaz, TPE, masivní dřevo

Povrchy: SNI, Cr, SNI-broušeno, TiN-C, TiN-B, TiN-K, Ms, Ms-A, Ms-L, zakázkově TiN-A, TiN-S

více info na [www.kliky-mt.cz/manufaktura/barvy-povrchy](http://www.kliky-mt.cz/manufaktura/barvy-povrchy)

Dveřní zarážky M&T v navržených designech splňují i náročné požadavky investorů pro dokonalé sladění interiérů s dveřním kováním v jednotném designu i požadované barevnosti. Podobně tak i zarážky Wood z masivního dřeva s kovovou konstrukcí. Zarážky Minimal / Maximal jsou jasnou volbou pro milovníky designu, kde i na takovém detailu jakou je dveřní zarážka, lze navrhnout svůj osobitý design vložení libovolného materiálu do pohledové části zarážky. Zarážku Multi díky své struktuře a plastičnosti lze použít jak na podlahu, tak i na stěnu (materiál TPE - termoplastický elastomer).

LUSY



MINIMAL / MAXIMAL



MULTI



WOOD



### konstrukční varianty

- Lusy, Burak, Minimal / Maximal, Multi, Wood pro montáž do podlahy pomocí hmoždinky
- zarážka Multi s montáží i do stěny
- v nabídce také přídržovač M&T s hmotností 1,4 kg bez montáže na hmoždinku
- záruka 3 roky, titany 15 let

roky **3 garance** | let **15 garance**

Ochranné známky – registrované značky

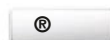

**MINIMAL®**  
**MAXIMAL®**

Chráněné průmyslové vzory zarážka



**MINIMAL**  
**MAXIMAL**



SNi matný nikel



**Dveřní zarážka Lusy**

420,- Kč  
18,- EUR

Kč	materiál: ocel povrch: SNi matný nikel	EUR
420,-		18,-



**Přidržovač dveří**

780,- Kč  
33,- EUR

Kč	materiál: ocel povrch: SNi matný nikel	EUR
780,-		33,-



jasan



ořech

**Dveřní zarážka Wood**

640,- Kč  
27,- EUR

Kč	materiál: masivní dřevo + ocel povrch: olejováno	EUR
640,-		27,-



bělený dub



dub

		SNI		NRz		Cr		TiN-C		TiN-K	
		cena / ks	EAN	cena / ks	EAN	cena / ks	EAN	cena / ks	EAN	cena / ks	EAN
výška / průměr 30 / 40 mm	Kč €	420,- 18,-	26001	420,- 18,-	43268	420,- 18,-	25981	560,- 24,-	25967	720,- 30,-	26285
výška / průměr 40 / 40 mm	Kč €	430,- 18,-	26018	430,- 18,-	43329	430,- 18,-	25998	590,- 25,-	25974	750,- 32,-	25950

		SNI		Cr		TiN-C		TiN-K	
		cena / ks	EAN	cena / ks	EAN	cena / ks	EAN	cena / ks	EAN
výška / průměr 42 / 80 mm	Kč €	780,- 33,-	78352	780,- 33,-	78369	1090,- 46,-	78383	1260,- 53,-	78390

Přidržovač dveří s hmotností 1,4 kg se nevtá do podlahy, pouze se na podlahu pokládá. Na spodní straně je opatřen protiskluzným materiálem, který zabraňuje snadnému posouvání po podlaze a zároveň jakémukoliv poškrábání podlahy.

		Teak		Dub		Ořech		Jasan		Bělený dub	
		cena / ks	EAN	cena / ks	EAN	cena / ks	EAN	cena / ks	EAN	cena / ks	EAN
	Kč €	640,- 27,-	028423	580,- 25,-	028430	580,- 25,-	028447	580,- 25,-	028454	620,- 26,-	028461

Zarážky Wood jsou vyráběny z masivního dřeva s kovovou konstrukcí garantující dlouhodobou životnost. Standardně dodáváno s černou gumou, možnost dodání s gumou šedou nebo čírou.



SNI matný nikel



Ti-B titan braun mat



Ms mosaz natural



MAXIMAL SNI matný nikel  
výplň kůže - hnědá čokoládová



**Dveřní zarážka**

**Minimal**

760,- Kč  
32,- EUR



Cr lesklý chrom

materiál: masivní mosaz  
povrch: SNI matný nikel

Kč

EUR

760,-



32,-



TiN-K titan černý mat

**Dveřní zarážka**

**Maximal**

830,- Kč  
35,- EUR

materiál: masivní mosaz  
povrch: SNI matný nikel

Kč

EUR

830,-



35,-

**Výplň zarážky  
Maximal**

95,- Kč  
4,- EUR



materiál: TPE  
povrch: různé barvy

Kč

EUR

430,-

18,-

**Dveřní zarážka MULTI**

430,- Kč  
18,- EUR



	<b>SNi</b>		<b>SNi - broušeno</b>		<b>Cr</b>		<b>Ms</b>		<b>Ms-A</b>		
	cena	EAN	cena	EAN	cena	EAN	cena	EAN	cena	EAN	
	ks		ks		ks		ks		ks		
Minimal	Kč €	760,- 32,-	003277	830,- 35,-	003284	840,- 35,-	003291	840,- 35,-	062588	980,- 41,-	101218

	<b>TiN-C</b>		<b>TiN-B</b>		<b>TiN-K</b>		<b>TiN-A</b>		
	cena	EAN	cena	EAN	cena	EAN	cena	EAN	
	ks		ks		ks		ks		
Minimal	Kč €	980,- 41,-	003307	1150,- 48,-	003314	1150,- 48,-	003321	1150,- 48,-	003338

Standardně dodáváno s černou gumou, možnost dodání s gumou šedou nebo čirou.



Ms-A mosaz antik



TiN-A titan mosaz mat



	<b>SNi</b>		<b>SNi - broušeno</b>		<b>Cr</b>		<b>Ms</b>		<b>Ms-A</b>		
	cena	EAN	cena	EAN	cena	EAN	cena	EAN	cena	EAN	
	ks		ks		ks		ks		ks		
Maximal	Kč €	830,- 35,-	003345	880,- 37,-	003352	920,- 39,-	003369	920,- 39,-	062601	1060,- 45,-	101386

	<b>TiN-C</b>		<b>TiN-B</b>		<b>TiN-K</b>		<b>TiN-A</b>		
	cena	EAN	cena	EAN	cena	EAN	cena	EAN	
	ks		ks		ks		ks		
Maximal	Kč €	1060,- 45,-	003376	1220,- 51,-	003383	1220,- 51,-	003390	1060,- 45,-	003406

	cena	EAN	
	ks		
dřevo	Kč €	95,- 4,-	003413
kov	Kč €	95,- 4,-	003420
kůže	Kč €	140,- 5,9	003437
efekt „sklo“	Kč €	140,- 5,9	003444
RAL barvy	Kč €	160,- 6,7	022537

	<b>Bílá</b>		<b>Černá</b>		<b>Hnědá</b>		
	cena	EAN	cena	EAN	cena	EAN	
	ks		ks		ks		
MULTI	Kč €	430,- 18,-	030778	430,- 18,-	030785	430,- 18,-	030792

Barevný odstín si ověřte u vašeho prodejce podle fyzického vzorku zarážky.



Příslušenství montážní šablony (lze objednat i samostatně)

**určeno pro každého montážníka**



profi-montážní utahovák  
červíků "červák" EAN 65499 cena 230,- Kč / 9,6 EUR

bit-imbus 3  
k červíku M6 pro montáž všech typů  
klik / rukojetí M&T  
EAN 65475 cena 59,- Kč / 2,5 EUR

bit-imbus 2 k červíku M4  
pro montáž rozet Minimal a dalších  
komponentů M&T  
EAN 91955 cena 59,- Kč / 2,5 EUR

bit-imbus 2,5 k červíku M5  
pro montáž všech  
WC mechanismů M&T  
EAN 65482 cena 59,- Kč / 2,5 EUR

## Montážní PROFI šablona

Použití: univerzální pro všechny typy zámků, na veškeré rozetové kování M&T

Montážní PROFI šablona M&T je určena pro vrtání přesných otvorů sloužících k rychlé a kvalitní montáži veškerého rozetového kování M&T. Jedinečná konstrukce vrtací šablony je připravena pro univerzální použití na všechny rozměry/rozteče dveřních zámků, které jsou dostupné na trhu. Zároveň je ihned použitelná pro všechny typy/varianty zámků. Dodává se v sadě s PROFI montážním utahovákem, sadou bitů a zajišťovacím gelem proti uvolnění šroubových spojů.

PROFI šablona M&T



kompletní montážní kufřík s PROFI šablonou M&T



### konstrukční varianty, materiálové provedení

- dokonalá konstrukce pro naprosto přesné vrtání požadovaných otvorů
- pohyblivé bloky šablony pro vrtání zámků všech rozměrů
- fixace polohy šablony bočními červíky pro opakované vrtání většího počtu stejných dveří
- zaslepovací magnetky pro eliminaci chybného vrtání
- celý sortiment rozetového kování M&T montován pomocí jedné univerzální PROFI šablony M&T
- PROFI šablona určena i pro bezpečnostní rozety
- vodící čep pro cylindrickou vložku lze nastavovat podle tl. dveří
- součástí montážního kufříku je sada všech potřebných vrtáků
- v sadě je dále PROFI montážní utahovák, sada bitů, zajišťovací gel
- přehledná animace montáže s veškerým použitím šablony

Patent

celková konstrukce šablony a systém použití

patent

Univerzální PROFI šablona M&T by neměla chybět u žádného prodejce, u žádného montážníka pracujícího s kvalitními produkty M&T.

Samozřejmostí je možnost zapůjčení PROFI šablony k montáži rozetového kování M&T všem prodejcům, montážníkům a koncovým zákazníkům viz. informace na [www.kliky-mt.cz/montaze-kovani](http://www.kliky-mt.cz/montaze-kovani).



kufřík s vrtací PROFI šablonou + PROFI utahovákem  
EAN 90255 cena 2840,- Kč / 119,- EUR



Animace použití šablony  
nebo na [www.kliky-mt.cz/montaze-kovani](http://www.kliky-mt.cz/montaze-kovani)

## Příslušenství a komponenty

Veškeré uváděné komponenty slouží pro dokonalý servis a dlouhodobou funkčnost a životnost kování. Komponenty M&T nejsou standardním obchodním artiklem a neposkytují se na ně obchodní slevy.

Pouzdro	cena ks	EAN
25 mm	Kč € 19,- 0,8	18099
40 mm	Kč € 30,- 1,3	007190
53 mm	Kč € 39,- 1,7	007206

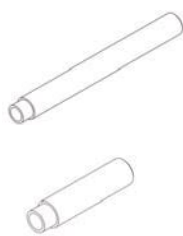

Šrouby M4 k pouzdrům	cena ks	EAN
4 x 16 mm	Kč € 5,- 0,3	034783
4 x 35 mm	Kč € 6,- 0,3	034790
4 x 50 mm	Kč € 7,- 0,3	034806



Vrutky ke štítkům	cena ks	EAN
SNi	Kč € 5,- 0,3	034875
NRz	Kč € 6,- 0,3	034882
černé	Kč € 5,- 0,3	034899



Pružina	cena ks	EAN
standard	Kč € 14,- 0,6	50365
pro Magnetické rozety	Kč € 17,- 0,8	157437



Rozpěrný čtyřhran pro jednostrannou kliku	cena ks	EAN
□ 8 x 8 mm délka od osy zámku 50 mm	Kč € 430,- 18,-	30206
□ 8 x 8 mm délka od osy zámku 70 mm	Kč € 520,- 22,-	14213
□ 8 x 8 mm délka od osy zámku 90 mm	Kč € 580,- 25,-	035247
□ 8 x 8 mm / 10 x 10 mm délka od osy zámku 50 mm	Kč € 580,- 25,-	30268
□ 8 x 8 mm / 10 x 10 mm délka od osy zámku 70 mm	Kč € 720,- 30,-	035254
□ 8 x 8 mm / 10 x 10 mm délka od osy zámku 90 mm	Kč € 850,- 36,-	035261

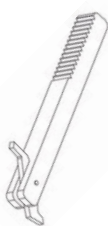

Rozpěrný čtyřhran se rozpirá / fixuje v očích zámku, ne za zámkem. Více informací na [www.kliky-mt.cz/montaze-kovani](http://www.kliky-mt.cz/montaze-kovani).

Kroužek pojistný (ségrovka)	cena ks	EAN
Ø 14	Kč € 7,- 0,3	50457



Plastové podrozety pod rukojeti (vnitřní)	cena pár	EAN
design 2000	Kč € 56,- 2,4	034813
design 2004	Kč € 65,- 2,8	034820
design 2006	Kč € 140,- 5,9	034837
design 2009	Kč € 140,- 5,9	034844
design 2011 / 2013	Kč € 140,- 5,9	034851



Šrouby M4 k pouzdrům Mini, Minimal, Maximal	cena ks	EAN
4 x 16 mm	Kč € 9,- 0,4	082340
4 x 35 mm	Kč € 10,- 0,5	082357
4 x 50 mm	Kč € 12,- 0,5	082364



Čtyřhran s drážkou □ 8 x 8 mm	Ocel cena / ks	EAN	Nerez cena / ks	EAN
80 mm	Kč € 37,- 1,6	28111	78,- 3,3	034622
83 mm	Kč € 37,- 1,6	034578	78,- 3,3	034639
85 mm	Kč € 37,- 1,6	50013	78,- 3,3	034646
90 mm	Kč € 37,- 1,6	28128	78,- 3,3	034653
95 mm	Kč € 37,- 1,6	50020	78,- 3,3	034660
100 mm	Kč € 44,- 1,9	28135	86,- 3,6	034677
105 mm	Kč € 52,- 2,2	50037	110,- 4,6	034684
110 mm	Kč € 59,- 2,5	28142	120,- 5,0	034691
120 mm	Kč € 65,- 2,8	28159	140,- 5,9	034707
130 mm	Kč € 73,- 3,1	28166	160,- 6,7	034714
140 mm	Kč € 81,- 3,4	28173	170,- 7,1	034721
150 mm	Kč € 86,- 3,6	28180	190,- 8,-	034738
160 mm	Kč € 94,- 4,0	034585	200,- 8,4	034745
170 mm	Kč € 110,- 4,6	034592	220,- 9,2	034752
180 mm	Kč € 120,- 5,0	034608	230,- 9,6	034769
190 mm	Kč € 120,- 5,0	034615	250,- 11,-	034776



Imbus klíč	cena ks	EAN
2	Kč 8,- € 0,4	034905
2,5	Kč 9,- € 0,4	50501
3	Kč 10,- € 0,5	27114

Protiplech různé typy podle typu kliky	cena ks	EAN
	Kč 12,- € 0,5	035063

Zajišťovač šroubových spojů	cena ks	EAN
0,5 ml	Kč 65,- € 2,8	034929
5 ml	Kč 120,- € 5,-	40090

Plastové podložky ke klikám	cena ks	EAN
černá	Kč 9,- € 0,4	043167
šedá	Kč 9,- € 0,4	043174

Různé druhy podle typu kliky.

Vložka závěsu kovová	cena ks	EAN
pro pant Metrik	Kč 72,- € 3,0	73111

Okenní mechanismus	cena ks	EAN
kovový 37 mm	Kč 160,- € 6,7	119770
kovový 42 mm	Kč 160,- € 6,7	119787
kovový 50 mm	Kč 170,- € 7,1	119794
kovový 61 mm	Kč 200,- € 8,4,-	119800
plastový	Kč 62,- € 2,6	90309

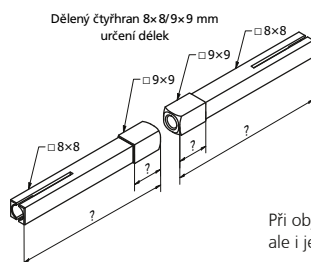
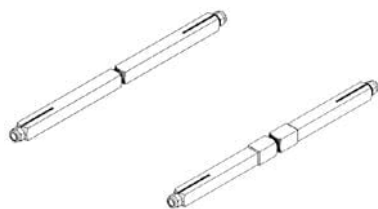

Montážní materiál pro rozetové kování	cena sada	EAN
tl. dveří 46-55 mm	Kč 44,- € 1,9	27978
56-71 mm	Kč 86,- € 3,6	27985
72-85 mm	Kč 170,- € 7,1	28005
86-126 mm	Kč 250,- € 11,-	91153

Montážní materiál pro sešroubování skrze dveře pro štitové kování	cena sada	EAN
tl. dveří 38-45 mm	Kč 59,- € 2,5	066401
46-55 mm	Kč 86,- € 3,6	066418
56-71 mm	Kč 120,- € 5,-	066425
72-85 mm	Kč 170,- € 7,1	066432
86-126 mm	Kč 250,- € 11,-	066449

Čtyřhran WC □ 6 x 6 mm	cena ks	EAN
45 mm	Kč 15,- € 0,7	035018
53 mm	Kč 15,- € 0,7	035025
63 mm	Kč 16,- € 0,7	50068
66 mm	Kč 17,- € 0,8	035032
70 mm	Kč 19,- € 0,8	50075
80 mm	Kč 23,- € 1,0	035049
85 mm	Kč 25,- € 1,1	035056

Červíky	Nerez cena / ks	EAN	Černý cena / ks	EAN
M4x4 plochý	Kč 14,- € 0,6	035148	8,- 0,4	035155
M4x5 plochý	Kč 14,- € 0,6	035162	8,- 0,4	035179
M4x6 plochý	Kč 16,- € 0,7	035186	9,- 0,4	035193
M5x6 s hrotem	Kč		9,- 0,4	50495
M6x7 s nosem	Kč 19,- € 0,8	035216		
M6x8 s hrotem	Kč 19,- € 0,8	035223		
M6x10 s nosem	Kč		14,- 0,6	50488

Při objednání děleného čtyřhranu je třeba upřesnit nejen celkovou délku, ale i jednotlivé dílčí délky jednotlivých částí čtyřhranu.

Dělený čtyřhran	45/40 mm	EAN	45/50 mm	EAN	55/50 mm	EAN	60/60 mm	EAN	70/70 mm	EAN	70/75 mm	EAN	75/75 mm	EAN
	cena / ks		cena / ks		cena / ks		cena / ks		cena / ks		cena / ks		cena / ks	
□ 8x8 / 9x9 mm	Kč 580,- € 25,-	74408	640,- 27,-	079982	640,- 27,-	74422	720,- 30,-	74446	780,- 33,-	080001	780,- 33,-	080025	780,- 33,-	062700
□ 8x8 mm	Kč 520,- € 22,-	74392	590,- 25,-	079999	590,- 25,-	74415	650,- 28,-	74439	720,- 30,-	080018	720,- 30,-	080032	720,- 30,-	062694

<b>Rozety Design 2000, 2004</b>	<b>SNi</b> cena / pár	<b>EAN</b>	<b>SNi - br.</b> cena / pár	<b>EAN</b>	<b>Cr</b> cena / pár	<b>EAN</b>	<b>TiN-S</b> cena / pár	<b>EAN</b>	<b>TiN-C</b> cena / pár	<b>EAN</b>	<b>TiN-K</b> cena / pár	<b>EAN</b>	<b>TiN-A</b> cena / pár	<b>EAN</b>	
kulatá dozická	Kč €	120,- 5,-	034936	120,- 5,-	037357	230,- 9,6	037142	470,- 20,-	034950	470,- 20,-	037180	470,- 20,-	037210	470,- 20,-	037241
kulatá cylindrická	Kč €	120,- 5,-	037128	120,- 5,-	037364	230,- 9,6	037159	470,- 20,-	037173	470,- 20,-	037197	470,- 20,-	037227	470,- 20,-	037258
kulatá WC	Kč €	860,- 36,-	104165	860,- 36,-	104196	1010,- 43,-	104219	1250,- 53,-	104233	1250,- 53,-	104257	1250,- 53,-	104271	1250,- 53,-	104349
čtvercová dozická	Kč €	230,- 9,6	034943	230,- 9,6	037388	320,- 14,-	037166	580,- 25,-	034967	580,- 25,-	037203	580,- 25,-	037234	580,- 25,-	037265
čtvercová cylindrická	Kč €	230,- 9,6	037135	230,- 9,6	72152	320,- 14,-	72176	580,- 25,-	72190	580,- 25,-	72213	580,- 25,-	72237	580,- 25,-	72251
čtvercová WC	Kč €	1080,- 45,-	104172	1080,- 45,-	104202	1220,- 51,-	104226	1470,- 62,-	104240	1470,- 62,-	104264	1470,- 62,-	104288	1470,- 62,-	104356

Spodní krycí rozety včetně plast. podrozet a vrutů (EAN spodních rozet dalších designových řad jsou uvedeny v tabulkách přímo u dveřních klik).

<b>Rozety NRz</b>	<b>NRz</b> cena / pár	<b>EAN</b>	<b>Objekt titan</b> cena / pár	<b>EAN</b>	<b>K-industrial</b> cena / pár EAN		
kulatá dozická	Kč €	120,- 5,-	034974	440,- 19,-	034998	440,- 19,-	037296
kulatá cylindrická	Kč €	120,- 5,-	037272	440,- 19,-	037333	440,- 19,-	037302
kulatá WC	Kč €	600,- 25,-	104363	920,- 39,-	105209	920,- 39,-	138559
čtvercová dozická	Kč €	220,- 9,2	034981	530,- 23,-	035001	530,- 23,-	037319
čtvercová cylindrická	Kč €	220,- 9,2	037289	530,- 23,-	037340	530,- 23,-	037326
čtvercová WC	Kč €	770,- 33,-	105193	1140,- 48,-	105216	1140,- 48,-	138566

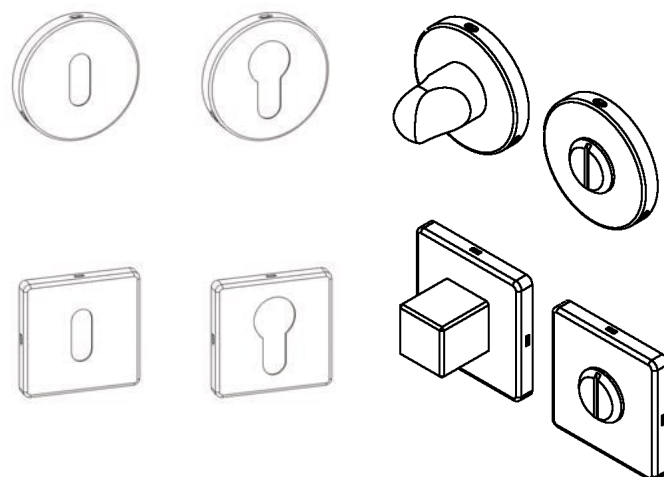

<b>Redukce</b>	<b>10 mm</b> cena / ks	<b>EAN</b>	<b>15 mm</b> cena / ks	<b>EAN</b>	<b>18 mm</b> cena / ks	<b>EAN</b>	<b>20 mm</b> cena / ks	<b>EAN</b>	<b>30 mm</b> cena / ks	<b>EAN</b>	
4/6 mm	Kč €	19,- 0,8	035070	22,- 1,-	035087						
5/6 mm	Kč €	19,- 0,8	035094	22,- 1,-	035100						
5/8 mm	Kč €								19,- 0,8	035117	
6/7 mm	Kč €			19,- 0,8	50570						
6/8 mm	Kč €					22,- 1,-	28050		25,- 1,1	035124	
8/8,5 mm	Kč €								25,- 1,1	50594	
8/9 mm	Kč €							30,- 1,3	28579	30,- 1,3	035131
8/10 mm	Kč €								30,- 1,3	50587	



Komponenty k zámkům a pantům na sklo

<b>Střední díl pantu</b>	cena ks	EAN
	Kč 64,- € 2,7	88221

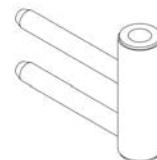

<b>Podložka pro kliku</b>	cena ks	EAN
černá	Kč 19,- € 0,8	88290
stříbrná	Kč 19,- € 0,8	88306



<b>Vanička do zárubně krycí</b>	cena ks	EAN
černá	Kč 29,- € 1,3	90897
stříbrná	Kč 29,- € 1,3	90903



<b>Vložka závěsu k pantům na sklo</b>	cena ks	EAN
	Kč 86,- € 3,6	88238

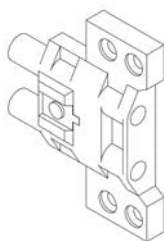

<b>Střední díl pantu do kovové zárubně</b>	cena ks	EAN
	Kč 78,- € 3,3	90866



<b>Spodní díl pantu</b>	cena ks	EAN
	Kč 64,- € 2,7	90873

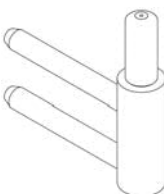

<b>Spodní díl pantu do kovové zárubně</b>	cena ks	EAN
	Kč 78,- € 3,3	90880

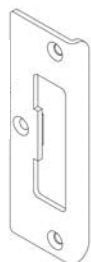
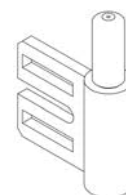

<b>Protiplech do dřevěné zárubně</b>	SNi cena / ks	EAN	SNi - br. cena / ks	EAN	Cr cena / ks	EAN	TiN-C cena / ks	EAN	TiN-K cena / ks	EAN	TiN-B cena / ks	EAN
	Kč 290,- € 13,-	88245	290,- 13,-	90859	370,- 16,-	88252	530,- 23,-	88276	580,- 25,-	88269	620,- 26,-	88283

<b>M&amp;T TITAN ochranný a čistící prostředek pro titanové a nerezové kování</b>	cena ks	EAN
125 ml	Kč 290,- € 13,-	034912



<b>M&amp;T SNI čistící prostředek pro kování s povrchem SNI matný nikl</b>	cena ks	EAN
50 ml	Kč 120,- € 5,-	132809



**M&T**

Maximal

MINIMAL

Maximal kůže

## Prezentační panely a vzorkovnice produktů

Prezentační systém M&T je připraven pro přehlednou prezentaci produktů, kde je možnost volby umístění – tzn. buď do prostoru, nebo na stěnu s možností výběru vystavených vzorků, které jsou umístěny na plexi destičkách. Výhodou je flexibilita při výměně vzorků, kdy stačí pouze vyměnit plexi destičku bez jakékoliv další montáže a demontáže. Samozřejmostí prezentací M&T je nadstandardní design prezentací, který odpovídá kvalitě vystavovaných produktů. K nejvyšším řadám kování jsou dále připraveny speciální vzorkové edice určené pro náročné zákazníky, kteří chtějí při vlastním výběru poznat možnosti povrchových úprav, barev a variant materiálů na produktech M&T.

Prezentační panel M&T oboustranný do prostoru



Prezentační panely M&T na stěnu



### konstrukční varianty, materiálové provedení

- vyměnitelné plexi destičky 140x235 mm, tl. 5 mm
- materiál plexi bílé lesklé opálové sklo pro zvýraznění produktu
- kování montováno se systémem vratných pružin jako na dveřích
- 9 pozic – destiček na jedné ploše prezentace
- panely na stěnu lze sestavovat vedle sebe v libovolném počtu
- panel do prostoru je oboustranný s 18 pozicemi plexi destiček
- materiál panelu přírodní dýha teak – olejováno
- rozměr panelu do prostoru - podstavec 300x400, výška panelu 1700 mm
- rozměr panelu na stěnu - šířka 380 mm, výška 1700 mm

Chráněné průmyslové vzory

design

prezentační panely M&T

se systémem vyměnitelných destiček

Využijte všech výhod a možností spolupráce a staňte se partnery M&T

Neustálé inovace v M&T



Klika Minimal light svítící 20 let, bez baterií, bez el. zdroje



**M&T 1997, a.s.**  
centrála  
Čs. odboje 1044  
518 01 Dobruška  
tel.: +420 491 474 632  
+420 774 700 258  
e-mail: info@kliky-mt.cz  
www.kliky-mt.cz

#### SHOWROOMY, PRODEJNÍ SKLADY

**M&T Praha**  
U Třešňovky 1795/2  
tel.: +420 286 840 726  
+420 776 741 233  
e-mail: obchod@kliky-mt-praha.cz  
www.kliky-mt-praha.cz

**M&T Plzeň**  
Guldenerova 23  
tel.: +420 377 243 423  
+420 602 414 149  
e-mail: objednavky@kliky-mt-plzen.cz  
www.kliky-mt-plzen.cz

**M&T Brno**  
Bratislavská 22  
tel.: +420 545 211 213  
e-mail: info@kliky-mt-brno.cz  
www.kliky-mt-brno.cz

**M&T Dobruška**  
Čs. odboje 1044  
tel.: +420 491 474 632  
+420 774 700 258  
e-mail: info@kliky-mt.cz  
www.kliky-mt.cz

**M&T Bratislava**  
Komplex NIDO-2  
Trnavská cesta 47  
tel.: +421 948 939 998  
+421 948 682 182  
e-mail: info@klucky-mt.sk  
www.klucky-mt.sk

Tento katalog / ceník je pouze informativní s možností změn a úprav během kalendářního roku. Tiskové chyby jsou vyhrazeny. Veškerá foto jsou pouze ilustrativní, přesné materiálové a barevné provedení výrobků si prohlédněte u svého prodejce kování M&T. Katalog / ceník neobsahuje kompletní údaje o rozměrech, konstrukčním provedení, použití, systémech montáže. Kompletní údaje o výrobcích M&T jsou uvedeny na [www.kliky-mt.cz](http://www.kliky-mt.cz).

Veškeré uváděné ceny v celém katalogu / ceníku jsou bez DPH.

# Jak funguje bezplatný doživotní servis?

1. Klíčky odmontujte u Vás ze dveří

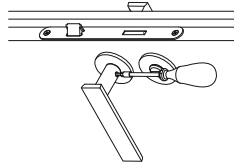

Před demontáží klíč si ověřte, že skutečně máte klíčky M&T. Identifikací je logo M&T vyražené na rozetě klíčky. V případě, že si nejste jisti, vyfoťte klíčky a zašlete foto k ověření na e-mail: [info@klucky-mtcz](mailto:info@klucky-mtcz)

2. Pečlivě je zabalte a vložte do zásilky vyplněný průvodní formulář se zpětnou adresou a telefonickým kontaktem na Vás

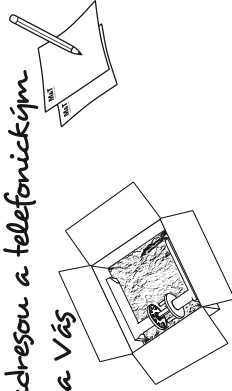

3. Zásilku doručte na některou z našich poboček

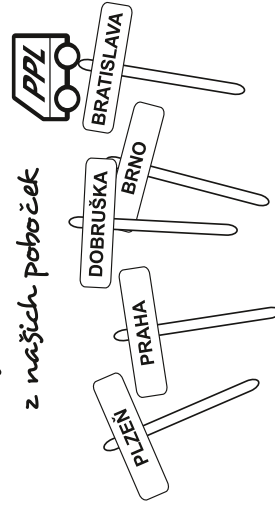

Adresy poboček jsou uvedeny na průvodním formuláři

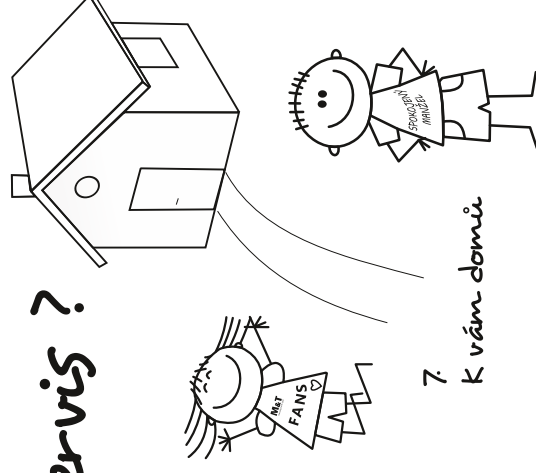

7. K vám domů

6. A zašleme zpět na naše náklady



5. Po té vaše klíčky zabalíme jako nové

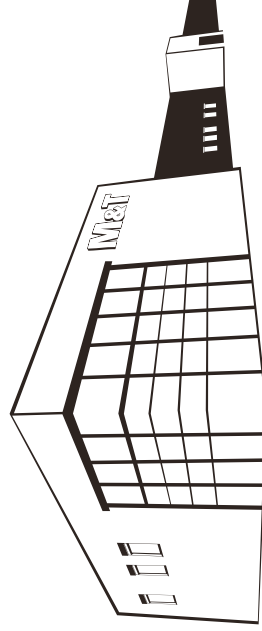
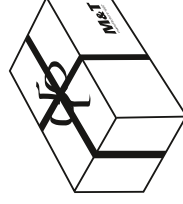

4. U nás v klikárně provedeme během 7 dní odborný servis, který obsahuje:

výměnu vrátných pružin



výměnu telefonových posudek



doplnění chybějících jstiček červíků



Promazání a čištění mechaniky nebo výměnu celých mechanik





