

2009



Platný od 1.3.2009



Pomocné pravítko

Odmerajte vzdialenosť medzi
osou kľučky a osou kľúča (rozteč)

Štandardné rozmery
sú zvýraznené červenou čiarou

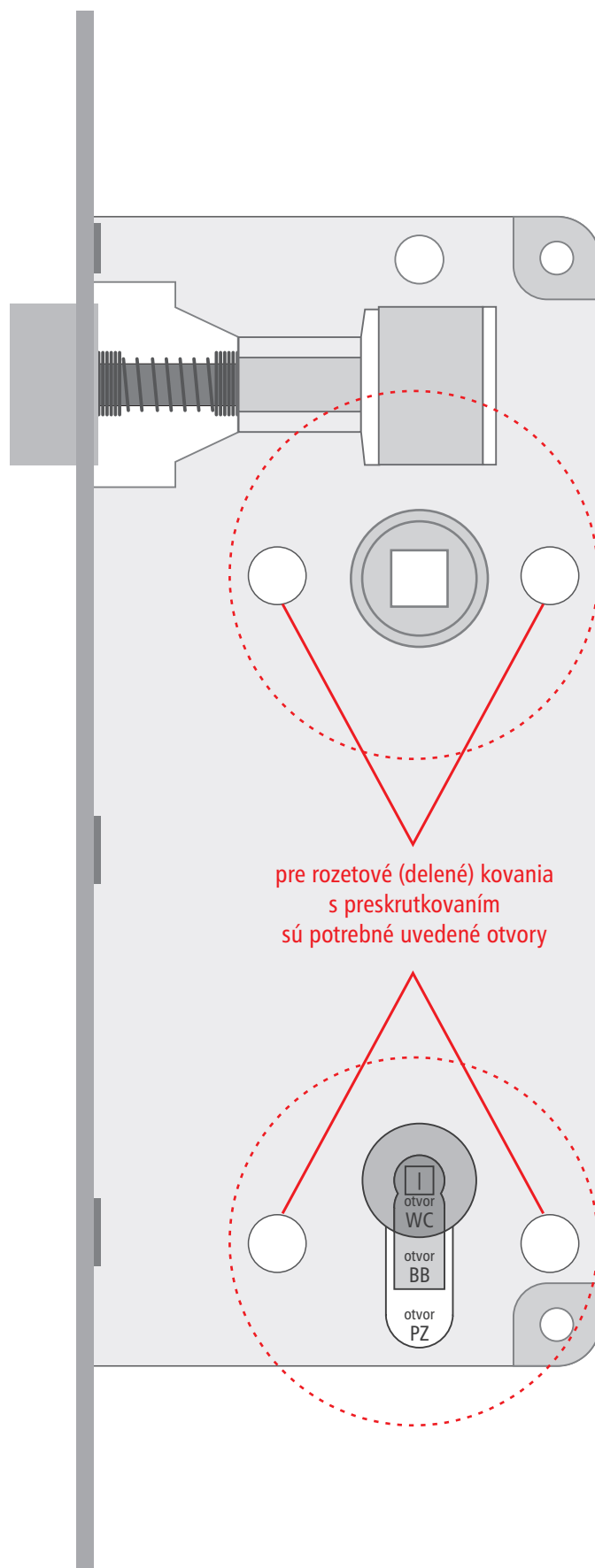
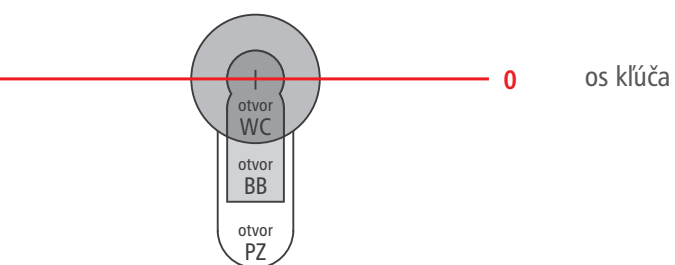
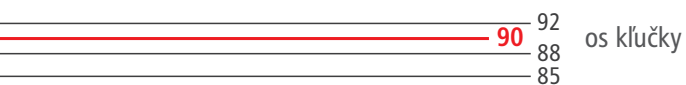

Vážení zákazníci,

formou nášho nového katalógu Vám chceme predstaviť sortiment, ktorý sme pre Vás pripravili. Našou snahou je vybrať tie najlepšie modely od renomovaných európskych výrobcov. Pri výbere sortimentu sme kládli dôraz na kvalitu, priaznivé ceny a zároveň zaujímavý dizajn.

Spoločnosť MP KOVANIA je firma so slovenským kapitálom založená v roku 2002. Od tohto obdobia pôsobí v oblasti dverných kovaní a doplnkov na celom území Slovenskej republiky a od roku 2008 aj na území Českej republiky. Prevádzkujeme veľkoobchodný a maloobchodný predaj so sieťou maloobchodných partnerov na celom území SR a ČR. V tejto oblasti dlhodobo budujeme meno kvalitného a spoľahlivého partnera. Naša spoločnosť vo svojej činnosti vsádza na stabilitu, spoľahlivosť v poskytovaní produktov a služieb, na kvalitnú a ochotnú predajnú i popredajnú starostlivosť.

S pozdravom kolektív MP KOVANIA

Niekoľko rád pred zakúpením kľučiek

Základné rozdelenie interiérových kľučiek:

Štítové kľučky | Pri štítových kľučkách je potrebné poznať vzdialenosť medzi osou kľučky a osou kľúča (rozteč). Štandardná vzdialenosť je 72, alebo 90 mm. Pri bezpečnostných kovaniach sa používa rozteč aj 92mm (prosím, zvýšte pozornosť pri meraní). Vzdialenosť (rozteč) si môžete odmerať pomocným pravítkom, ktoré nájdete na prvej strane katalógu.

UPOZORNENIE:

Nakoľko otvory do štítových kľučiek vyrážame na objednávku, je nevyhnutné, aby ste pri zadávaní objednávky presne uviedli typ a rozteč otvorov. Pokiaľ si objednáte nesprávne, nemusí byť ich výmena samozrejmosťou.

Rozetové kľučky | Rozetové, čiže delené kľučky, označujeme veľkým písmenom R (okružla rozeta) alebo HR (štvorcová rozeta). Nakoľko sa väčšina rozetových kľučiek upevňuje prešrôbovaním cez celú hrúbku dverí v mieste zámku, je potrebné, aby boli v zámku na to určené otvory. Sú znázornené v nákrese na prvej strane katalógu pri pomocnom pravítku.

Typy otvorov | Skratkou BB - označujeme otvor pre interiérový kľúč (dózický)

Skratkou PZ - označujeme otvor pre vložku (fabku)

Skratkou WC - označujeme WC sadu s vmontovaným kľúčom (k WC sade je potrebný zámok so spodným štvorhranným otvorom 6 x 6 mm)



BB



PZ



WC - sada

Guľa / Kľučka | Pri kľučkách s guľou uvádzame všetky predošlé údaje plus spresnenie, či sa jedná o kľučku pravú (označujeme RE) alebo ľavú (označujeme LI). Guľa, alebo madlo môže byť pevné alebo otočné.

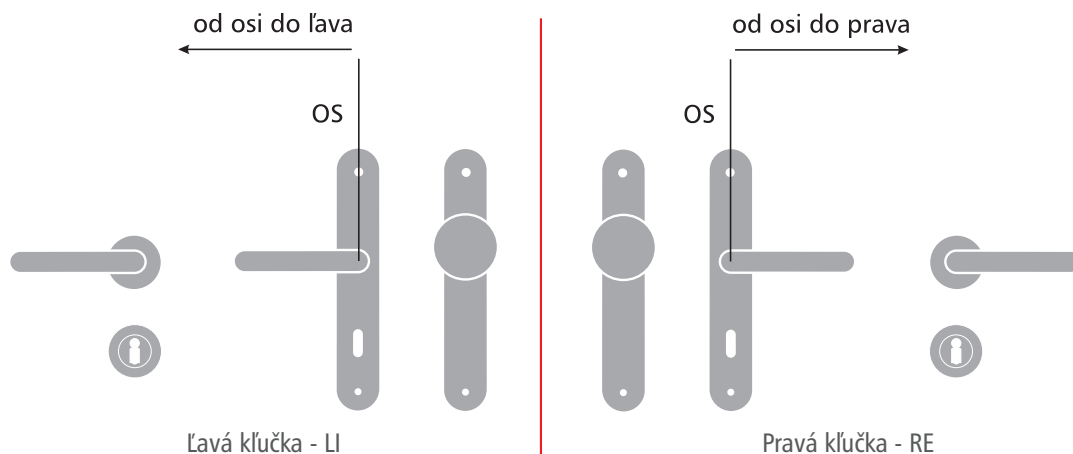

Povrchové úpravy

Vybraný sortiment v tomto katalógu je v rôznych povrchových úpravách. Výrobky sú ošetrené kvalitnými povrchovými úpravami, napriek tomu nie každá povrchová úprava je vhodná do každého prostredia. Pri každej povrchovej úprave sme vyznačili vhodnosť použitia symbolom:

- * určené pre domáce prostredie (byty, domy, malé penzióny)
- ** určené pre prostredie so zvýšenou frekvenciou pohybu ľudí (rodinné domy, hotely, ubytovne, menej frekventované administratívne priestory, penzióny)
- *** určené pre prostredie s vysokou frekvenciou pohybu ľudí (administratívne priestory, predajne, čerpacie stanice, nákupné centrá) a sú vhodné aj do vlhkého prostredia.

* Zlatá	– zlatý komaxit	** F1	– prírodný elox
* Biela	– biely komaxit	** F2	– šampáňo elox
* Strieborná	– strieborný komaxit	** F3	– zlatý elox
* Hnedá	– hnedý komaxit	** F4	– bronz elox
* Antik	– antik komaxit	** F9	– nerez elox
* ANS	– hliník poniklovaný	* OLV	– mosadz leštená a lakovaná
** AOC	– hliník pochromovaný	*** OLV/N	– mosadz leštená a lakovaná/nerez
* BVOC	– čierny velvet chróm	* OLV/OLS	– mosadz leštená a lakovaná/mosadz brúsená
*** LN	– leštená nerez	* ONL/ONS	– nikel lesklý/nikel brúsený
*** N	– nerez	* ONS	– nikel brúsený
*** N/OC/N	– nerez/chróm lesklý/nerez	* ONS/CH	– nikel brúsený/čerešňa
* OBA	– antik bronz	* ONS/W	– nikel brúsený/wenge
* BAN	– antik čierny	** ONS/OC	– nikel brúsený/chróm lesklý
** OC	– chróm lesklý	*** PVD INOX	– 10 rokov záruka
* OC/B	– chróm lesklý/čierny	*** PVD ZLATÁ	– 10 rokov záruka
* OC/BVOC	– chróm lesklý/čierny velvet chróm	** VOC	– velvet chróm
*** OC/N	– chróm lesklý/nerez	*** VOC/N	– velvet chróm/nerez
** OC/ONS	– chróm lesklý/nikel brúsený	** VONS	– velvet nikel
** OCS	– chróm brúsený	*** VONS/NL	– velvet nikel/nerez lesklá
* OCS/CH	– chróm brúsený/čerešňa	** B	– biely komaxit
* OCS/W	– chróm brúsený/wenge	*** Kovaná čierna	
** OCS/OC	– chróm brúsený/chróm lesklý	*** Kovaná sivá	
* OGR	– bronz česaný	** OC/OC/OCS	skratka pred prvým lomítkom označuje
** OGS	– bronz česaný mat	** OCS/OC/OCS	povrchovú úpravu štítu alebo rozety,
* OLS	– mosadz brúsená a lakovaná	* ONL/ONL/ONS	druhé dve skratky označujú kombináciu
*** OLS/N	– mosadz brúsená a lakovaná/nerez	* ONS/ONL/ONS	povrchov na kľučke

Pri niektorých produktoch s rovnakým označením povrchu (napr. F1 – prírodný elox) sa môžu vyskytnúť minimálne farebné odchýlky, nakoľko ide o produkty od rôznych výrobcov.

Montáž

Montáž je veľmi dôležitou súčasťou funkčnosti výrobku. Kladte, prosím, preto dôraz na jej správnosť, a to dôkladným, presným, priamym zameraním a vŕtaním otvorov. Odporúčame Vám používať montážne návody (sú súčasťou balenia kľúčiek, prípadne ich nájdete na našej webovej stránke, alebo sa poraďte u predajcu). Pri rozetových kovaniach odporúčame používať montážnu šablónu TUPAI (je vyobrazená v katalógu na strane 48). Neupravujte, prosím, kovanie pri montáži a použite na montáž príslušné diely, ktoré sa nachádzajú v balení. Nezapomnite pred inštaláciou mechaniku premazať univerzálnym mazivom napr. WD – 40.

Balenie tovaru

Pre dokonalé zaistenie ochrany výrobku a komfort prepravy sme pre Vás pripravili rozličné balenia výrobkov (sáčky, krabičky, kartóny, blistre atď.) Používame jednotný dizajn, ktorý je charakteristický pre značku MP KOVANIA.



Ošetrovanie

Na čistenie a ošetrovanie nepoužívajte žiadne agresívne chemikálie a čistiace prostriedky. Čistite len mäkkou vlhkou handrou. Pri vydávaní neštandardných (písklavých) zvukov alebo pri zadíhaní použite univerzálne mazivo napr. WD – 40.

Záruka

Záruka na výrobky uvedené v katalógu je minimálne 2 roky od dátumu predaja na pokladničnom doklade. Výrobky s predĺženou zárukou sú označené symbolom 3, 5 alebo 10 rokov.



Záruka sa nevzťahuje na poškodenie výrobku nesprávnym ošetrovaním, na opotrebovanie výrobku používaním, prípadne mechanickým poškodením (napr. kľúčmi, prstienkami a pod.) Záruka sa tiež nevzťahuje na výrobky, ktoré boli po zakúpení dodatočne upravované zákazníkom, alebo jeho montážnikom. Rovnako na výrobky znehodnotené nekvalitnou montážou, na znehodnotenie tovaru manipuláciou a vlastnou prepravou. Takisto na umiestnenie výrobku do nevhodného prostredia – pozrite „Povrchové úpravy - symboly“.

Garancia kvality

Pri dodržiavaní všetkých našich pokynov a upozornení (vhodný výber do prostredia, manipulácia s tovarom, kvalitná montáž a ošetrovanie výrobku) Vám garantujeme dlhodobú životnosť výrobkov.

Výmena tovaru

Pri akomkoľvek nároku na výmenu alebo reklamáciu tovaru žiadame zákazníkov, aby jednotlivé diely zabalili tak, aby nedošlo k ich ďalšiemu poškodeniu. V opačnom prípade poškodené diely nebudú vymenené.

Ceny

Ceny v katalógu sú platné od 1.3.2009. Sú uvedené za kompletný výrobok, v prípade kľúčiek za pár.

Ceny sú uvedené v: € bez DPH | € s DPH | SKK s DPH - informatívna cena.

Pri odbere tovaru v hodnote nižšej ako 100 € bez DPH (3126 Sk) bude k cene pripočítané prepravné vo výške 4,32 € bez DPH (130 Sk). Poplatok za dobierku platí zákazník pri prevzatí tovaru.

Z dôvodu nestability cien materiálov na svetovom trhu, si vyhradujeme právo na úpravu cien.

Aktualizácie cien a sortimentu nájdete na adrese: www.mp-kovania.sk

Tovar uvedený v katalógu je skladový sortiment, ale vzhľadom na širokú škálu môže dôjsť ku krátkodobým položkovým výpadkom tovaru.

Za pochopenie ďakujeme a veríme, že budete s naším tovarom a poskytovanými službami spokojní.

Ako správne objednávať kovania

Pri objednávke štítového kovania je dôležité uviesť rozteč, vzdialenosť v milimetroch od osy kľučky po os kľúča (na zmeranie Vám pomôže pravítko, ktoré nájdete na prednej strane katalógu).

Objednávka kľúčiek

Štítové kľučky:

1. Názov modelu – napr. LEA 1941 (vrátane príslušného číselného kódu výrobku – ak sa pri danom modeli uvádza)
2. Povrch – napr. OGS alebo OCS alebo OLV ...
3. Typ otvoru – BB alebo PZ alebo WC
4. Rozteč – 72 alebo 90 alebo 92 mm
5. Prevedenie kľučka/kľučka alebo guľa/kľučka alebo madlo/kľučka
6. Pri guľa/kľučka alebo madlo/kľučka uviesť či pravá alebo ľavá podľa obrázku na str. 2 v dolnej časti
7. Počet kusov – napr. 8ks

Objednávka bude potom vyzerat nasledovne:
LEA 1941 OGS BB 72 kľučka/kľučka - 8 ks



Rozetové kľučky (delené):

1. Názov modelu – napr. KLASIK - R (uviesť vrátane „R“ alebo „HR“ a príslušného číselného kódu výrobku – ak sa pri danom modeli uvádza)
2. Povrch – napr. F1 alebo OC alebo ONS ...
3. Typ otvoru – BB alebo PZ alebo WC
4. Prevedenie kľučka/kľučka alebo guľa/kľučka alebo madlo/kľučka
5. Pri guľa/kľučka alebo madlo/kľučka uviesť či pravá alebo ľavá podľa obrázku na str. 2 v dolnej časti
6. Počet kusov – napr. 10ks

Objednávka bude potom vyzerat nasledovne:
KLASIK - R F1 PZ guľa/kľučka pravá - 10 ks



Poznámka: Štandardná hrúbka interiérových dverí je 40mm. Pokiaľ máte inú hrúbku dverí, uveďte to prosím v objednávke.

Rozdelenie sérií

HLINÍK (str. 9 - 30)

jedná sa o ekonomickú triedu kľučiek. Vzhľadom na dobré a dlhodobé skúsenosti, ktoré máme viac ako šesť rokov, sme záruku zvýšili o ďalších 12 mesiacov.

NEREZ - NEHRDZAVEJÚCA OCEĽ (str. 31 - 36)

hlavné zastúpenie v tejto sérii kľučiek má portugalský výrobca TUPAI. Modely sú vyrobené z kvalitnej ušľachtilej nehrdzavejúcej ocele – nerez. Vo výrobkoch je použitá vysokokvalitná patentovaná mechanika uložená v zinkovom púzdre. Od roku 2009 v predaji s klikovým systémom nacvakávania krytiel mechaniky. Kľučky sú vhodné pre priestory s vysokou frekvenciou pohybu ľudí. Poskytovaná záruka je 5 rokov na kompletný výrobok.

NEREZ / MOSADZ alebo ZLIATINA ZINKU - kombinované (str. 37 - 47)

pri výrobe sú používané veľmi kvalitné materiály – nehrdzavejúca oceľ, mosadz alebo zliatina zinku. Mechanické časti kľučiek sú rovnako kvalitné ako v predchádzajúcej sérii NEREZ. Kľučky sú vhodné pre priestory s vysokou frekvenciou pohybu ľudí. Výrobca poskytuje zvýšenú záruku 5 rokov.

MOSADZ alebo ZLIATINA ZINKU (str. 49 - 100)

kľučky v tejto sérii sú starostlivo vyberané od renomovaných európskych výrobcov (TUPAI Portugalsko, MARIANI a iných poväčšine talianskych výrobcov). Uvedená séria zahŕňa jednoduchšie a lacnejšie modely, strednú triedu až po dizajnové kľučky.

Pri väčšine kľučiek z tejto série je použitá novo-vyvinutá šróbovací rozeta, ktorú oceníte pre jednoduchú montáž a dokonalú funkčnosť. Veľká časť kľučiek v tejto sérii (TUPAI) má nové zdokonalené uchytenie krytky rozety špeciálnym klikom (podrobnejší popis nájdete na strane 42).

V tejto sérii kľučiek je predovšetkým dôležité vybrať správny povrch kľučky vzhľadom na umiestnenie a použitie kľučky vo vybranom prostredí (informácie o povrchových úpravách nájdete v našom katalógu v časti „Povrchové úpravy“ na strane 3).

Na väčšinu uvedených modelov poskytujeme zvýšenú záruku (všimajte si, prosím, piktogramy označujúce dĺžku záruky). Podmienkou splnenia maximálnej záruky je dodržiavanie našich upozornení a odporúčaní.

GULE, MADLÁ A ROZETY (str. 101 - 113)

Gule a madlá - môžu byť pevné aj otočné. V našej ponuke nájdete rôzne dizajny, tvary, materiály a povrchové úpravy.

Rozety - sú použité pri jednotlivých sériách kľučiek a zároveň slúžia aj ako náhradné diely.

BEZPEČNOSTNÉ KOVANIA (str. 114 - 132)

v ponuke máme bohatý výber certifikovaných bezpečnostných kovaní v bezpečnostnej triede 3 (BT3). Kovania sú prispôbené na Slovensku používaným zámkom v roztečiach 72, 90, 92mm. Veľkou výhodou je možnosť ich zladenia s interiérovým kovaním v rôznych povrchových úpravách a farebných odtieňoch.

V ponuke máme aj rozetové (delené) bezpečnostné kovania.

Bezpečnostné kovanie sa montuje pomocou dlhých skrutiek z vnútornej strany. Z vonkajšej strany môže byť guľa, madlo alebo kľučka s ochranným štítom proti rozlomeniu a odvrtaniu bezpečnostnej vložky. Niektoré typy majú ochrannú krytku (prekrytie), ktorá zabraňuje nežiaducej manipulácii s vložkou.

KOVANÉ KĽUČKY (str. 133 - 135)

jedná sa o individuálnu sériu kľučiek vhodnú najmä pre vonkajšie použitie (bránky, vstupy do domov a budov s osobitým charakterom). Kľučky sú odolné voči poveternostným vplyvom a sú vhodné do akéhokoľvek prostredia.





OKENNÉ KĽUČKY (str. 136 - 146)

k väčšine kľučiek na dvere ponúkame na zladenie Vášho interiéru i kľučky na okná (prevažne na euro okná). Ceny jednotlivých okenných kľučiek si môžete všimnúť priamo v cenovke pri danom modeli kľučky na dvere, prípadne v časti venovanej okenným kľučkám.

































































DOPLNKY (str. 147 - 173)









v závere katalógu si môžete vybrať z množstva doplnkov k dverným kovaniam ako sú napr. zámky a vložky do dverí, hliníkové a plastové vetracie mriežky, samozatvárače dverí, zarážky dverí, držiaky drevených madiel, drevené madlá, nerezové madlá, okopové plechy, drevené prahy, číslice atď...

Abecedný zoznam kľúčiek











	séria	názov kľučky	strana	séria	názov kľučky	strana	séria	názov kľučky	strana	
A		A NOX CO - R	30		COMET	95-96		KLASIK - R	13	
		A NOX FA - HR	29		COMET - HR	95-96		KNUT - R OVÁL	134	
		A NOX FA - R	30		COSLAN	25		KONSTANZ	135	
		A NOX MO - R	30		COSLAN - R	25		KRISTINA 2	57-58	
		A NOX NE - HR	29		COSLAN - R 2000	32		KRISTINA 2 - R	57-58	
		A NOX NE - R	30		COSLAN - R OVÁL	25	L		LAGUNA - HR 2254 Q	35
		A NOX SW - HR	29		COSLAN - R OVÁL 2070	32			LAGUNA - R 2254	35
		A NOX SW - R	30		COSLAN 897	31		LAURA	9	
		A NOX WA - R	30		COSLAN ŠPECIAL 2003	31		LAURA - R	9	
		ADONIS - R	38		CRONO	18		LAURA 2	55-56	
		AGAVE	134		CRONO - R	18		LAURA 2 - R	55-56	
		ALBAN	133	D		DACAPO - HRN 791 A / Q	38		LEA - R 1948	75
		ALEX	50			DACAPO - R 791 / A	38		LEA 1941	75
		ALEX - R	50		DAFNE	22		LINHA 1 - HR 2736 Q	87	
		ALISSE - R	54		DAFNE - R	22		LINHA 2 - HR 2730 Q	88	
		ALT WIEN	52		DANIELA - HR 2253 Q	35		LUCIA	12	
		ARCH	19		DANIELA - R 2253	35		LUCIA - R	12	
		ARCH - R	19		DEA	71-72		LUXOR	11	
		ARTE	91-92		DEA - R	71-72		LUXOR - R	11	
		ARTE - HR	91-92		DENVER - R	47	M		MARENA - HR 794 Q	39
		ATZ 1 - HR 2277 Q	42		DIAGO - HR 793 Q	37			MARENA - R 794	39-40
		ATZ 2 - HR 2278 Q	42		DIAGO - HRN 793 Q	38		MARIANE - R	54	
		ATZ 1 - HRN 2277 Q	42		DIAGO - R 793	37		MEDOX	16	
		ATZ 2 - HRN 2278 Q	42		DIANA - HR 2251 Q	36		MEDOX - R	16	
	B		BALI - R	40		DIANA - R 2251	36		META 2055	41
		BALI HRN Q	40		DOTS - HR Q	81		META - HR 795 Q	41	
		BARON - R	40		DOTS - R	81		META - HRN 795 Q	41	
		BONA - R 311	81		DUCON - R	40		META - R 795	41	
		BREMEN	134	E		EAGLE - R	77		MICHAELA	10
		BREST - HR 2030 / B Q	43-44			ELIPSE - HR Q	34		MILA	73-74
		BREST - HR 2031 / A Q	43-44		ELIPSE - R	34		MILA - R	73-74	
		BREST - HR 2040 / C Q	43-44		ELEGANT	52		MILENA	51-52	
		BREST - HRN 2031 A / Q	38	F		FAN	69-70		MILENA - R	51-52
		BREST - R 2030 / B	43-44			FAN - R	69-70		MILLY	74
		BREST - R 2031 / A	43-44		FAVORIT	26		MILLY - R	74	
		BREST - R 2040/C	43-44		FAVORIT - HR 2002 Q	33		MIRA	15	
		BURACO 1 - HR 2737 Q	84		FAVORIT - R	26		MIRA - R	15	
		BURACO 2 - HR 2735 Q	84		FAVORIT - R 2002	33		MONA - R 2001	32	
C			CAIRO - HR 2731 Q	85		FAVORIT - R 2002 LN	32		MONA - R OVÁL 2071	32
			CARINA	73		FAVORIT - R OVÁL 2072	32		MONA 898	31
			CARINA - R	73		FAVORIT 899	31		MONA ŠPECIAL 2004	31
			CARLA - R 738	75		FAVORIT ŠPECIAL 2005	31		MONIKA	9-10
		CARLA 704	75		FLORENZ	135	N		NÁHRADNÝ DIEL NA DREVO	90
		CAST	65-66	G		GARDA		27		NERO - HR 2233 Q
		CAST - R	65-66			GARDA - R	27		NERO - R 2233	33
		CINTO - HR 2732 Q	86		GARDA - R ANS	26		NETUNO	28	
		CLAUDIA - R 1938	77		GARDA - R AOC	26		NETUNO - R	28	
		CLERMONT - HR 2026 / B Q	45-46		GIADA	61-62		NINA - R 1927	76	
		CLERMONT - HR 2027 / A Q	45-46		GIADA - R	61-62		NÜRBERG	134	
		CLERMONT - HR 2038 / C Q	45-46		GOLF	99	O		ORION 2	63-64
	CLERMONT - R 2026 / B	45-46		GOLF - HR	99			ORION 2 - R	63-64	
	CLERMONT - R 2027 / A	45-46	CH		CHERRY PRISMA - HR Q	90		OVER - HR	94	
	CLERMONT - R 2038 / C	45-46		J		JENNY - R 1929	80	P		PETRA 2
	CLOUD - HR	94	K			KLASIK	13			PETRA 2 - R

Abecedný zoznam kľúčiek

séria	názov kľučky	strana	séria	názov kľučky	strana	séria	názov kľučky	strana
	POLO - HR 2252 Q	36		SOUND - R	96		VERONA - R	23
	POLO - R 2252	36		SQUARE - HR 2275 Q	83		VERONA - R 1908	79
	PORT - R OVÁL	134		SUN 1 - HR	97		VERONA - R 2250	34
	PRADO - HR 792 Q	37		SUN 2 - HR	98		VIENNA	21
	PRADO - HRN 792 Q	38		SUN 3 - HR	98		VIENNA - R	21
	PRADO - R 792	37		SWING - HR 2232 Q	33		VIKTORIA - R 2032 / A	47
	PRELUDE 2	59-60		SWING - R 2232	33		VIKTORIA - R 2041 / C	47
	PRELUDE 2 - R	59-60		TARO - R 1977	79		VIKTORIA - R 2042 / B	47
	PRISMA - HR 1921 Q	89-90		TARO 1971	79		VIRGINIA - R 2221	47
R 	REAL	20		THEMA	49		VITO	24
	REAL - R	20		THEMA - R	49		VITO - R	24
	ROMBO - R	54		TILLY	133	W 	WENGE PRISMA - HR Q	90
S 	SABINA	17		TILLY - R OVÁL	133		WIGO - R	81
	SABINA - R	17		TILLY - ÚZKY ŠTÍT	133	X 	XENA - HR 2021 Q	36
	SAMBA	14		TORNÁDO - HR Q	35		XENA - R 2021	36
	SAMBA - R	14		TORNÁDO - R	35	Z 	ZANO	67-68
	SCAN - R	96		TRENDY - R	34		ZANO - R	67-68
	SECO - HR 1964 Q	82	U 	URBAN	134		ZENITH	93
	SECO - R 1964	82	V 	VEGA - HR 2230 Q	34		ZENITH - HR	93
	SINUA - R	96		VEGA - R 2230	34		ZOE	100
	SOFIA - R 1917	76		VERONA	23		ZOE - R	100
	SOFIA 1911	76						

	Hliník	strana	- 9 - 30		Bezpečnostné kovania	strana	- 114 - 132
	Nerez - nehrdzavejúca oceľ		- 31 - 36		Kované kľučky		- 133 - 135
	Nerez / mosadz alebo zliatina zinku		- 37 - 47		Okenné kľučky		- 136 - 146
	Mosadz alebo zliatina zinku		- 49 - 100		Doplňky		- 147 - 173
	Gule madlá a rozety		- 101 - 113		Šablóna TUPAI		- 48

Piktogramy - vysvetlivky

			záruka 3, 5 alebo 10 rokov		dodáciu lehotu si prosím preverte
	vratná pružina kľučky		certifikované kovanie bezpečnostná trieda 3		
	preskrutkovanie cez dvere		vhodný na protipožiariarne dvere (samozatvárače GEZE)		
	klikové nasadenie krytky rozety (TUPAI)		závitové nasadenie krytky rozety		



LAURA

povrch | zlatá

	Cena		
	bez DPH €	s DPH €	s DPH SK
BB-otvor pre kľúč	3,82	4,55	137,-
PZ-otvor pre vložku	3,82	4,55	137,-
otvor - WC sada	4,82	5,74	173,-
guľa / kľučka PZ	4,82	5,74	173,-



LAURA

povrch | biela

	Cena		
	bez DPH €	s DPH €	s DPH SK
BB-otvor pre kľúč	3,82	4,55	137,-
PZ-otvor pre vložku	3,82	4,55	137,-
otvor - WC sada	4,82	5,74	173,-
guľa / kľučka PZ	4,82	5,74	173,-



LAURA

povrch | strieborná

	Cena		
	bez DPH €	s DPH €	s DPH SK
BB-otvor pre kľúč	3,82	4,55	137,-
PZ-otvor pre vložku	3,82	4,55	137,-
otvor - WC sada	4,82	5,74	173,-
guľa / kľučka PZ	4,82	5,74	173,-



LAURA

povrch | hnedá

	Cena		
	bez DPH €	s DPH €	s DPH SK
BB-otvor pre kľúč	3,82	4,55	137,-
PZ-otvor pre vložku	3,82	4,55	137,-
otvor - WC sada	4,82	5,74	173,-
guľa / kľučka PZ	4,82	5,74	173,-



LAURA

povrch | antik

	Cena		
	bez DPH €	s DPH €	s DPH SK
BB-otvor pre kľúč	3,82	4,55	137,-
PZ-otvor pre vložku	3,82	4,55	137,-
otvor - WC sada	4,82	5,74	173,-
guľa / kľučka PZ	4,82	5,74	173,-



LAURA - R

povrch | strieborná

	Cena		
	bez DPH €	s DPH €	s DPH SK
BB-otvor pre kľúč	3,82	4,55	137,-
PZ-otvor pre vložku	3,82	4,55	137,-
otvor - WC sada	4,82	5,74	173,-
guľa / kľučka PZ	4,82	5,74	173,-



MONIKA

povrch | zlatá

	Cena		
	bez DPH €	s DPH €	s DPH SK
BB-otvor pre kľúč	3,82	4,55	137,-
PZ-otvor pre vložku	3,82	4,55	137,-
otvor - WC sada	4,82	5,74	173,-
guľa / kľučka PZ	4,82	5,74	173,-



MONIKA

povrch | biela

	Cena		
	bez DPH €	s DPH €	s DPH SK
BB-otvor pre kľúč	3,82	4,55	137,-
PZ-otvor pre vložku	3,82	4,55	137,-
otvor - WC sada	4,82	5,74	173,-
guľa / kľučka PZ	4,82	5,74	173,-



MONIKA

povrch | strieborná

	Cena		
	bez DPH €	s DPH €	s DPH SK
BB-otvor pre kľúč	3,82	4,55	137,-
PZ-otvor pre vložku	3,82	4,55	137,-
otvor - WC sada	4,82	5,74	173,-
guľa / kľučka PZ	4,82	5,74	173,-



MONIKA

povrch | hnedá

	Cena		
	bez DPH €	s DPH €	s DPH SK
BB-otvor pre kľúč	3,82	4,55	137,-
PZ-otvor pre vložku	3,82	4,55	137,-
otvor - WC sada	4,82	5,74	173,-
guľa / kľučka PZ	4,82	5,74	173,-



MONIKA

povrch | antik

	Cena		
	bez DPH €	s DPH €	s DPH SK
BB-otvor pre kľúč	3,82	4,55	137,-
PZ-otvor pre vložku	3,82	4,55	137,-
otvor - WC sada	4,82	5,74	173,-
guľa / kľučka PZ	4,82	5,74	173,-



MICHAELA

povrch | zlatá

	Cena		
	bez DPH €	s DPH €	s DPH SK
BB-otvor pre kľúč	3,82	4,55	137,-
PZ-otvor pre vložku	3,82	4,55	137,-
otvor - WC sada	4,82	5,74	173,-
guľa / kľučka PZ	4,82	5,74	173,-



MICHAELA

povrch | biela

	Cena		
	bez DPH €	s DPH €	s DPH SK
BB-otvor pre kľúč	3,82	4,55	137,-
PZ-otvor pre vložku	3,82	4,55	137,-
otvor - WC sada	4,82	5,74	173,-
guľa / kľučka PZ	4,82	5,74	173,-



MICHAELA

povrch | strieborná

	Cena		
	bez DPH €	s DPH €	s DPH SK
BB-otvor pre kľúč	3,82	4,55	137,-
PZ-otvor pre vložku	3,82	4,55	137,-
otvor - WC sada	4,82	5,74	173,-
guľa / kľučka PZ	4,82	5,74	173,-



MICHAELA

povrch | hnedá

	Cena		
	bez DPH €	s DPH €	s DPH SK
BB-otvor pre kľúč	3,82	4,55	137,-
PZ-otvor pre vložku	3,82	4,55	137,-
otvor - WC sada	4,82	5,74	173,-
guľa / kľučka PZ	4,82	5,74	173,-



MICHAELA

povrch | antik

	Cena		
	bez DPH €	s DPH €	s DPH SK
BB-otvor pre kľúč	3,82	4,55	137,-
PZ-otvor pre vložku	3,82	4,55	137,-
otvor - WC sada	4,82	5,74	173,-
guľa / kľučka PZ	4,82	5,74	173,-



LUXOR

povrch | F1 - prírodný elox



	Cena		
	bez DPH €	s DPH €	s DPH SK
BB-otvor pre kľúč	6,61	7,87	237,-
PZ-otvor pre vložku	6,61	7,87	237,-
otvor - WC sada	9,49	11,29	340,-
guľa / kľučka PZ	9,32	11,09	334,-



LUXOR

povrch | F2 - šampáňo elox



	Cena		
	bez DPH €	s DPH €	s DPH SK
BB-otvor pre kľúč	6,61	7,87	237,-
PZ-otvor pre vložku	6,61	7,87	237,-
otvor - WC sada	9,49	11,29	340,-
guľa / kľučka PZ	9,32	11,09	334,-



LUXOR

povrch | F4 - bronz elox



	Cena		
	bez DPH €	s DPH €	s DPH SK
BB-otvor pre kľúč	6,61	7,87	237,-
PZ-otvor pre vložku	6,61	7,87	237,-
otvor - WC sada	9,49	11,29	340,-
guľa / kľučka PZ	9,32	11,09	334,-



LUXOR

povrch | F9 - nerez elox



	Cena		
	bez DPH €	s DPH €	s DPH SK
BB-otvor pre kľúč	7,50	8,93	269,-
PZ-otvor pre vložku	7,50	8,93	269,-
otvor - WC sada	10,51	12,51	377,-
guľa / kľučka PZ	10,24	12,18	367,-

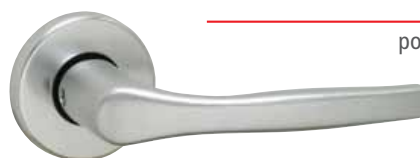

LUXOR - R

povrch | F1 - prírodný elox



	Cena		
	bez DPH €	s DPH €	s DPH SK
BB-otvor pre kľúč	7,65	9,10	274,-
PZ-otvor pre vložku	7,65	9,10	274,-
otvor - WC sada	11,21	13,34	402,-
guľa / kľučka PZ	12,81	15,24	459,-

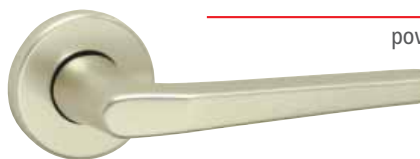

LUXOR - R

povrch | F2 - šampáňo elox



	Cena		
	bez DPH €	s DPH €	s DPH SK
BB-otvor pre kľúč	7,65	9,10	274,-
PZ-otvor pre vložku	7,65	9,10	274,-
otvor - WC sada	11,21	13,34	402,-
guľa / kľučka PZ	12,81	15,24	459,-



LUXOR - R

povrch | F4 - bronz elox



	Cena		
	bez DPH €	s DPH €	s DPH SK
BB-otvor pre kľúč	7,65	9,10	274,-
PZ-otvor pre vložku	7,65	9,10	274,-
otvor - WC sada	11,21	13,34	402,-
guľa / kľučka PZ	12,81	15,24	459,-



LUXOR - R

povrch | F9 - nerez elox



	Cena		
	bez DPH €	s DPH €	s DPH SK
BB-otvor pre kľúč	8,45	10,06	303,-
PZ-otvor pre vložku	8,45	10,06	303,-
otvor - WC sada	12,39	14,74	444,-
guľa / kľučka PZ	14,39	17,13	516,-





LUCIA

povrch | F1 - prírodný elox



	Cena		
	bez DPH €	s DPH €	s DPH SK
BB-otvor pre kľúč	7,31	8,70	262,-
PZ-otvor pre vložku	7,31	8,70	262,-
otvor - WC sada	10,07	11,98	361,-
guľa / kľučka PZ	9,62	11,45	345,-



LUCIA - R

povrch | F1 - prírodný elox



	Cena		
	bez DPH €	s DPH €	s DPH SK
BB-otvor pre kľúč	8,14	9,69	292,-
PZ-otvor pre vložku	8,14	9,69	292,-
otvor - WC sada	11,69	13,91	419,-
guľa / kľučka PZ	13,05	15,53	468,-



LUCIA

povrch | F2 - šampáňo elox



	Cena		
	bez DPH €	s DPH €	s DPH SK
BB-otvor pre kľúč	7,31	8,70	262,-
PZ-otvor pre vložku	7,31	8,70	262,-
otvor - WC sada	10,07	11,98	361,-
guľa / kľučka PZ	9,62	11,45	345,-

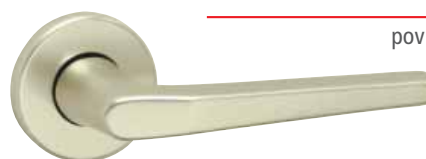

LUCIA - R

povrch | F2 - šampáňo elox



	Cena		
	bez DPH €	s DPH €	s DPH SK
BB-otvor pre kľúč	8,14	9,69	292,-
PZ-otvor pre vložku	8,14	9,69	292,-
otvor - WC sada	11,69	13,91	419,-
guľa / kľučka PZ	13,05	15,53	468,-



LUCIA

povrch | F4 - bronz elox



	Cena		
	bez DPH €	s DPH €	s DPH SK
BB-otvor pre kľúč	7,31	8,70	262,-
PZ-otvor pre vložku	7,31	8,70	262,-
otvor - WC sada	10,07	11,98	361,-
guľa / kľučka PZ	9,62	11,45	345,-

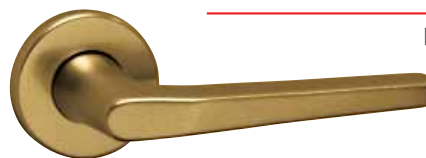

LUCIA - R

povrch | F4 - bronz elox



	Cena		
	bez DPH €	s DPH €	s DPH SK
BB-otvor pre kľúč	8,14	9,69	292,-
PZ-otvor pre vložku	8,14	9,69	292,-
otvor - WC sada	11,69	13,91	419,-
guľa / kľučka PZ	13,05	15,53	468,-



LUCIA

povrch | F9 - nerez elox



	Cena		
	bez DPH €	s DPH €	s DPH SK
BB-otvor pre kľúč	7,92	9,43	284,-
PZ-otvor pre vložku	7,92	9,43	284,-
otvor - WC sada	10,97	13,05	393,-
guľa / kľučka PZ	10,43	12,41	374,-

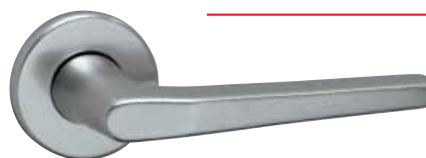

LUCIA - R

povrch | F9 - nerez elox



	Cena		
	bez DPH €	s DPH €	s DPH SK
BB-otvor pre kľúč	8,79	10,46	315,-
PZ-otvor pre vložku	8,79	10,46	315,-
otvor - WC sada	12,72	15,14	456,-
guľa / kľučka PZ	14,56	17,33	522,-



KLASIK

povrch | F1 - prírodný elox



	Cena		
	bez DPH €	s DPH €	s DPH SK
BB-otvor pre kľúč	8,59	10,22	308,-
PZ-otvor pre vložku	8,59	10,22	308,-
otvor - WC sada	11,44	13,61	410,-
guľa / kľučka PZ	10,27	12,22	368,-



KLASIK

povrch | F2 - šampáňo elox



	Cena		
	bez DPH €	s DPH €	s DPH SK
BB-otvor pre kľúč	8,59	10,22	308,-
PZ-otvor pre vložku	8,59	10,22	308,-
otvor - WC sada	11,44	13,61	410,-
guľa / kľučka PZ	10,27	12,22	368,-



KLASIK

povrch | F4 - bronz elox



	Cena		
	bez DPH €	s DPH €	s DPH SK
BB-otvor pre kľúč	8,59	10,22	308,-
PZ-otvor pre vložku	8,59	10,22	308,-
otvor - WC sada	11,44	13,61	410,-
guľa / kľučka PZ	10,27	12,22	368,-



KLASIK

povrch | F9 - nerez elox



	Cena		
	bez DPH €	s DPH €	s DPH SK
BB-otvor pre kľúč	9,57	11,39	343,-
PZ-otvor pre vložku	9,57	11,39	343,-
otvor - WC sada	12,55	14,94	450,-
guľa / kľučka PZ	11,27	13,41	404,-



KLASIK - R

povrch | F1 - prírodný elox



	Cena		
	bez DPH €	s DPH €	s DPH SK
BB-otvor pre kľúč	9,60	11,42	344,-
PZ-otvor pre vložku	9,60	11,42	344,-
otvor - WC sada	13,17	15,67	472,-
guľa / kľučka PZ	13,78	16,40	494,-



KLASIK - R

povrch | F2 - šampáňo elox



	Cena		
	bez DPH €	s DPH €	s DPH SK
BB-otvor pre kľúč	9,60	11,42	344,-
PZ-otvor pre vložku	9,60	11,42	344,-
otvor - WC sada	13,17	15,67	472,-
guľa / kľučka PZ	13,78	16,40	494,-



KLASIK - R

povrch | F4 - bronz elox



	Cena		
	bez DPH €	s DPH €	s DPH SK
BB-otvor pre kľúč	9,60	11,42	344,-
PZ-otvor pre vložku	9,60	11,42	344,-
otvor - WC sada	13,17	15,67	472,-
guľa / kľučka PZ	13,78	16,40	494,-



KLASIK - R

povrch | F9 - nerez elox



	Cena		
	bez DPH €	s DPH €	s DPH SK
BB-otvor pre kľúč	10,51	12,51	377,-
PZ-otvor pre vložku	10,51	12,51	377,-
otvor - WC sada	14,45	17,19	518,-
guľa / kľučka PZ	15,43	18,36	553,-





SAMBA

povrch | F1 - prírodný elox



	Cena		
	bez DPH €	s DPH €	s DPH SK
<i>Italy</i> BB-otvor pre kľúč	11,18	13,31	401,-
PZ-otvor pre vložku	11,18	13,31	401,-
otvor - WC sada	13,95	16,60	500,-
guľa / kľučka PZ	12,28	14,61	440,-



SAMBA - R

povrch | F1 - prírodný elox



	Cena		
	bez DPH €	s DPH €	s DPH SK
<i>Italy</i> BB-otvor pre kľúč	10,97	13,05	393,-
PZ-otvor pre vložku	10,97	13,05	393,-
otvor - WC sada	14,50	17,26	520,-
guľa / kľučka PZ	14,45	17,19	518,-



SAMBA

povrch | F4 - bronz elox



	Cena		
	bez DPH €	s DPH €	s DPH SK
<i>Italy</i> BB-otvor pre kľúč	11,18	13,31	401,-
PZ-otvor pre vložku	11,18	13,31	401,-
otvor - WC sada	13,95	16,60	500,-
guľa / kľučka PZ	12,28	14,61	440,-



SAMBA - R

povrch | F4 - bronz elox



	Cena		
	bez DPH €	s DPH €	s DPH SK
<i>Italy</i> BB-otvor pre kľúč	10,97	13,05	393,-
PZ-otvor pre vložku	10,97	13,05	393,-
otvor - WC sada	14,50	17,26	520,-
guľa / kľučka PZ	14,45	17,19	518,-



SAMBA

povrch | F9 - nerez elox



	Cena		
	bez DPH €	s DPH €	s DPH SK
<i>Italy</i> BB-otvor pre kľúč	12,35	14,70	443,-
PZ-otvor pre vložku	12,35	14,70	443,-
otvor - WC sada	15,37	18,29	551,-
guľa / kľučka PZ	13,42	15,97	481,-



SAMBA - R

povrch | F9 - nerez elox



	Cena		
	bez DPH €	s DPH €	s DPH SK
<i>Italy</i> BB-otvor pre kľúč	12,03	14,31	431,-
PZ-otvor pre vložku	12,03	14,31	431,-
otvor - WC sada	15,98	19,02	573,-
guľa / kľučka PZ	16,82	20,02	603,-





MIRA

povrch | F1 - prírodný elox



	Cena		
	bez DPH €	s DPH €	s DPH SK
<i>Italy</i> BB-otvor pre kľúč	9,76	11,62	350,-
PZ-otvor pre vložku	9,76	11,62	350,-
otvor - WC sada	12,52	14,90	449,-
guľa / kľučka PZ	11,52	13,71	413,-



MIRA - R

povrch | F1 - prírodný elox



	Cena		
	bez DPH €	s DPH €	s DPH SK
<i>Italy</i> BB-otvor pre kľúč	9,54	11,35	342,-
PZ-otvor pre vložku	9,54	11,35	342,-
otvor - WC sada	13,08	15,57	469,-
guľa / kľučka PZ	13,75	16,36	493,-



MIRA

povrch | F4 - bronz elox



	Cena		
	bez DPH €	s DPH €	s DPH SK
<i>Italy</i> BB-otvor pre kľúč	9,76	11,62	350,-
PZ-otvor pre vložku	9,76	11,62	350,-
otvor - WC sada	12,52	14,90	449,-
guľa / kľučka PZ	11,52	13,71	413,-



MIRA - R

povrch | F4 - bronz elox



	Cena		
	bez DPH €	s DPH €	s DPH SK
<i>Italy</i> BB-otvor pre kľúč	9,54	11,35	342,-
PZ-otvor pre vložku	9,54	11,35	342,-
otvor - WC sada	13,08	15,57	469,-
guľa / kľučka PZ	13,75	16,36	493,-



MIRA

povrch | F9 - nerez elox



	Cena		
	bez DPH €	s DPH €	s DPH SK
<i>Italy</i> BB-otvor pre kľúč	10,76	12,81	386,-
PZ-otvor pre vložku	10,76	12,81	386,-
otvor - WC sada	13,78	16,40	494,-
guľa / kľučka PZ	12,64	15,04	453,-



MIRA - R

povrch | F9 - nerez elox



	Cena		
	bez DPH €	s DPH €	s DPH SK
<i>Italy</i> BB-otvor pre kľúč	10,43	12,41	374,-
PZ-otvor pre vložku	10,43	12,41	374,-
otvor - WC sada	14,39	17,13	516,-
guľa / kľučka PZ	15,37	18,29	551,-





MEDOX

povrch | F1 - prírodný elox



	Cena		
	bez DPH €	s DPH €	s DPH SK
<i>Italy</i> BB-otvor pre kľúč	10,10	12,02	362,-
PZ-otvor pre vložku	10,10	12,02	362,-
otvor - WC sada	12,86	15,30	461,-
guľa / kľučka PZ	11,69	13,91	419,-



MEDOX - R

povrch | F1 - prírodný elox



	Cena		
	bez DPH €	s DPH €	s DPH SK
<i>Italy</i> BB-otvor pre kľúč	9,87	11,75	354,-
PZ-otvor pre vložku	9,87	11,75	354,-
otvor - WC sada	13,42	15,97	481,-
guľa / kľučka PZ	13,92	16,56	499,-



MEDOX

povrch | F4 - bronz elox



	Cena		
	bez DPH €	s DPH €	s DPH SK
<i>Italy</i> BB-otvor pre kľúč	10,10	12,02	362,-
PZ-otvor pre vložku	10,10	12,02	362,-
otvor - WC sada	12,86	15,30	461,-
guľa / kľučka PZ	11,69	13,91	419,-

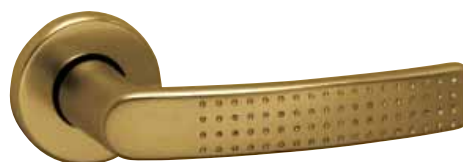

MEDOX - R

povrch | F4 - bronz elox



	Cena		
	bez DPH €	s DPH €	s DPH SK
<i>Italy</i> BB-otvor pre kľúč	9,87	11,75	354,-
PZ-otvor pre vložku	9,87	11,75	354,-
otvor - WC sada	13,42	15,97	481,-
guľa / kľučka PZ	13,92	16,56	499,-



MEDOX

povrch | F9 - nerez elox



	Cena		
	bez DPH €	s DPH €	s DPH SK
<i>Italy</i> BB-otvor pre kľúč	11,10	13,21	398,-
PZ-otvor pre vložku	11,10	13,21	398,-
otvor - WC sada	14,12	16,80	506,-
guľa / kľučka PZ	12,81	15,24	459,-



MEDOX - R

povrch | F9 - nerez elox



	Cena		
	bez DPH €	s DPH €	s DPH SK
<i>Italy</i> BB-otvor pre kľúč	10,76	12,81	386,-
PZ-otvor pre vložku	10,76	12,81	386,-
otvor - WC sada	14,73	17,53	528,-
guľa / kľučka PZ	15,54	18,49	557,-





SABINA

povrch | F1 - prírodný elox



	Cena		
	bez DPH €	s DPH €	s DPH SK
<i>Italy</i> BB-otvor pre kľúč	9,26	11,02	332,-
PZ-otvor pre vložku	9,26	11,02	332,-
otvor - WC sada	12,03	14,31	431,-
guľa / kľučka PZ	11,29	13,44	405,-



SABINA - R

povrch | F1 - prírodný elox



	Cena		
	bez DPH €	s DPH €	s DPH SK
<i>Italy</i> BB-otvor pre kľúč	9,03	10,75	324,-
PZ-otvor pre vložku	9,03	10,75	324,-
otvor - WC sada	12,58	14,97	451,-
guľa / kľučka PZ	13,50	16,07	484,-



SABINA

povrch | F4 - bronz elox



	Cena		
	bez DPH €	s DPH €	s DPH SK
<i>Italy</i> BB-otvor pre kľúč	9,26	11,02	332,-
PZ-otvor pre vložku	9,26	11,02	332,-
otvor - WC sada	12,03	14,31	431,-
guľa / kľučka PZ	11,29	13,44	405,-



SABINA - R

povrch | F4 - bronz elox



	Cena		
	bez DPH €	s DPH €	s DPH SK
<i>Italy</i> BB-otvor pre kľúč	9,03	10,75	324,-
PZ-otvor pre vložku	9,03	10,75	324,-
otvor - WC sada	12,58	14,97	451,-
guľa / kľučka PZ	13,50	16,07	484,-



SABINA

povrch | F9 - nerez elox



	Cena		
	bez DPH €	s DPH €	s DPH SK
<i>Italy</i> BB-otvor pre kľúč	10,57	12,58	379,-
PZ-otvor pre vložku	10,57	12,58	379,-
otvor - WC sada	13,59	16,17	487,-
guľa / kľučka PZ	12,52	14,90	449,-



SABINA - R

povrch | F9 - nerez elox



	Cena		
	bez DPH €	s DPH €	s DPH SK
<i>Italy</i> BB-otvor pre kľúč	10,24	12,18	367,-
PZ-otvor pre vložku	10,24	12,18	367,-
otvor - WC sada	14,20	16,90	509,-
guľa / kľučka PZ	15,26	18,16	547,-





CRONO

povrch | F1 - prírodný elox



	Cena		
	bez DPH €	s DPH €	s DPH SK
<i>Italy</i> BB-otvor pre kľúč	10,66	12,68	382,-
PZ-otvor pre vložku	10,66	12,68	382,-
otvor - WC sada	13,42	15,97	481,-
guľa / kľučka PZ	11,99	14,27	430,-



CRONO - R

povrch | F1 - prírodný elox



	Cena		
	bez DPH €	s DPH €	s DPH SK
<i>Italy</i> BB-otvor pre kľúč	10,43	12,41	374,-
PZ-otvor pre vložku	10,43	12,41	374,-
otvor - WC sada	13,97	16,63	501,-
guľa / kľučka PZ	14,20	16,90	509,-



CRONO

povrch | F4 - bronz elox



	Cena		
	bez DPH €	s DPH €	s DPH SK
<i>Italy</i> BB-otvor pre kľúč	10,66	12,68	382,-
PZ-otvor pre vložku	10,66	12,68	382,-
otvor - WC sada	13,42	15,97	481,-
guľa / kľučka PZ	11,99	14,27	430,-



CRONO - R

povrch | F4 - bronz elox



	Cena		
	bez DPH €	s DPH €	s DPH SK
<i>Italy</i> BB-otvor pre kľúč	10,43	12,41	374,-
PZ-otvor pre vložku	10,43	12,41	374,-
otvor - WC sada	13,97	16,63	501,-
guľa / kľučka PZ	14,20	16,90	509,-



CRONO

povrch | F9 - nerez elox



	Cena		
	bez DPH €	s DPH €	s DPH SK
<i>Italy</i> BB-otvor pre kľúč	11,80	14,04	423,-
PZ-otvor pre vložku	11,80	14,04	423,-
otvor - WC sada	14,82	17,63	531,-
guľa / kľučka PZ	13,17	15,67	472,-



CRONO - R

povrch | F9 - nerez elox



	Cena		
	bez DPH €	s DPH €	s DPH SK
<i>Italy</i> BB-otvor pre kľúč	11,46	13,64	411,-
PZ-otvor pre vložku	11,46	13,64	411,-
otvor - WC sada	15,43	18,36	553,-
guľa / kľučka PZ	16,54	19,68	593,-





ARCH

povrch | F1 - prírodný elox



	Cena		
	bez DPH €	s DPH €	s DPH SK
<i>Italy</i> BB-otvor pre kľúč	12,35	14,70	443,-
PZ-otvor pre vložku	12,35	14,70	443,-
otvor - WC sada	15,12	17,99	542,-
guľa / kľučka PZ	12,83	15,27	460,-



ARCH - R

povrch | F1 - prírodný elox



	Cena		
	bez DPH €	s DPH €	s DPH SK
<i>Italy</i> BB-otvor pre kľúč	12,13	14,44	435,-
PZ-otvor pre vložku	12,13	14,44	435,-
otvor - WC sada	15,67	18,65	562,-
guľa / kľučka PZ	15,03	17,89	539,-



ARCH

povrch | F4 - bronz elox



	Cena		
	bez DPH €	s DPH €	s DPH SK
<i>Italy</i> BB-otvor pre kľúč	12,35	14,70	443,-
PZ-otvor pre vložku	12,35	14,70	443,-
otvor - WC sada	15,12	17,99	542,-
guľa / kľučka PZ	12,83	15,27	460,-



ARCH - R

povrch | F4 - bronz elox



	Cena		
	bez DPH €	s DPH €	s DPH SK
<i>Italy</i> BB-otvor pre kľúč	12,13	14,44	435,-
PZ-otvor pre vložku	12,13	14,44	435,-
otvor - WC sada	15,67	18,65	562,-
guľa / kľučka PZ	15,03	17,89	539,-



ARCH

povrch | F9 - nerez elox



	Cena		
	bez DPH €	s DPH €	s DPH SK
<i>Italy</i> BB-otvor pre kľúč	13,61	16,20	488,-
PZ-otvor pre vložku	13,61	16,20	488,-
otvor - WC sada	16,66	19,82	597,-
guľa / kľučka PZ	14,06	16,73	504,-



ARCH - R

povrch | F9 - nerez elox



	Cena		
	bez DPH €	s DPH €	s DPH SK
<i>Italy</i> BB-otvor pre kľúč	13,28	15,80	476,-
PZ-otvor pre vložku	13,28	15,80	476,-
otvor - WC sada	17,24	20,51	618,-
guľa / kľučka PZ	16,79	19,98	602,-





REAL

povrch | F1 - prírodný elox



	Cena		
	bez DPH €	s DPH €	s DPH SK
BB-otvor pre kľúč	8,37	9,96	300,-
PZ-otvor pre vložku	8,37	9,96	300,-
otvor - WC sada	11,13	13,24	399,-
guľa / kľučka PZ	10,82	12,88	388,-



REAL - R

povrch | F1 - prírodný elox



	Cena		
	bez DPH €	s DPH €	s DPH SK
BB-otvor pre kľúč	8,14	9,69	292,-
PZ-otvor pre vložku	8,14	9,69	292,-
otvor - WC sada	11,69	13,91	419,-
guľa / kľučka PZ	13,05	15,53	468,-



REAL

povrch | F4 - bronz elox



	Cena		
	bez DPH €	s DPH €	s DPH SK
BB-otvor pre kľúč	8,37	9,96	300,-
PZ-otvor pre vložku	8,37	9,96	300,-
otvor - WC sada	11,13	13,24	399,-
guľa / kľučka PZ	10,82	12,88	388,-



REAL - R

povrch | F4 - bronz elox



	Cena		
	bez DPH €	s DPH €	s DPH SK
BB-otvor pre kľúč	8,14	9,69	292,-
PZ-otvor pre vložku	8,14	9,69	292,-
otvor - WC sada	11,69	13,91	419,-
guľa / kľučka PZ	13,05	15,53	468,-



REAL

povrch | F9 - nerez elox



	Cena		
	bez DPH €	s DPH €	s DPH SK
BB-otvor pre kľúč	9,79	11,65	351,-
PZ-otvor pre vložku	9,79	11,65	351,-
otvor - WC sada	12,81	15,24	459,-
guľa / kľučka PZ	12,16	14,47	436,-



REAL - R

povrch | F9 - nerez elox



	Cena		
	bez DPH €	s DPH €	s DPH SK
BB-otvor pre kľúč	9,45	11,25	339,-
PZ-otvor pre vložku	9,45	11,25	339,-
otvor - WC sada	13,42	15,97	481,-
guľa / kľučka PZ	14,87	17,69	533,-



VIENNA

povrch | F1 - prírodný elox



	Cena		
	bez DPH €	s DPH €	s DPH SK
<i>Italy</i> BB-otvor pre kľúč	10,13	12,05	363,-
PZ-otvor pre vložku	10,13	12,05	363,-
otvor - WC sada	13,45	16,00	482,-
guľa / kľučka PZ	14,25	16,96	511,-

VIENNA - R

povrch | F1 - prírodný elox



	Cena		
	bez DPH €	s DPH €	s DPH SK
<i>Italy</i> BB-otvor pre kľúč	9,18	10,92	329,-
PZ-otvor pre vložku	9,18	10,92	329,-
otvor - WC sada	12,72	15,14	456,-
guľa / kľučka PZ	13,55	16,13	486,-



VIENNA

povrch | F4 - bronz elox



	Cena		
	bez DPH €	s DPH €	s DPH SK
<i>Italy</i> BB-otvor pre kľúč	10,13	12,05	363,-
PZ-otvor pre vložku	10,13	12,05	363,-
otvor - WC sada	13,45	16,00	482,-
guľa / kľučka PZ	14,25	16,96	511,-

VIENNA - R

povrch | F4 - bronz elox



	Cena		
	bez DPH €	s DPH €	s DPH SK
<i>Italy</i> BB-otvor pre kľúč	9,18	10,92	329,-
PZ-otvor pre vložku	9,18	10,92	329,-
otvor - WC sada	12,72	15,14	456,-
guľa / kľučka PZ	13,55	16,13	486,-



VIENNA

povrch | F9 - nerez elox



	Cena		
	bez DPH €	s DPH €	s DPH SK
<i>Italy</i> BB-otvor pre kľúč	11,18	13,31	401,-
PZ-otvor pre vložku	11,18	13,31	401,-
otvor - WC sada	15,01	17,86	538,-
guľa / kľučka PZ	15,84	18,85	568,-

VIENNA - R

povrch | F9 - nerez elox



	Cena		
	bez DPH €	s DPH €	s DPH SK
<i>Italy</i> BB-otvor pre kľúč	10,10	12,02	362,-
PZ-otvor pre vložku	10,10	12,02	362,-
otvor - WC sada	14,06	16,73	504,-
guľa / kľučka PZ	15,84	18,85	568,-



DAFNE

povrch | F1 - prírodný elox



	Cena		
	bez DPH €	s DPH €	s DPH SK
<i>Italy</i> BB-otvor pre kľúč	10,66	12,68	382,-
PZ-otvor pre vložku	10,66	12,68	382,-
otvor - WC sada	13,42	15,97	481,-
guľa / kľučka PZ	11,99	14,27	430,-



DAFNE - R

povrch | F1 - prírodný elox



	Cena		
	bez DPH €	s DPH €	s DPH SK
<i>Italy</i> BB-otvor pre kľúč	10,43	12,41	374,-
PZ-otvor pre vložku	10,43	12,41	374,-
otvor - WC sada	13,97	16,63	501,-
guľa / kľučka PZ	14,17	16,86	508,-



DAFNE

povrch | F4 - bronz elox



	Cena		
	bez DPH €	s DPH €	s DPH SK
<i>Italy</i> BB-otvor pre kľúč	10,66	12,68	382,-
PZ-otvor pre vložku	10,66	12,68	382,-
otvor - WC sada	13,42	15,97	481,-
guľa / kľučka PZ	11,99	14,27	430,-



DAFNE - R

povrch | F4 - bronz elox



	Cena		
	bez DPH €	s DPH €	s DPH SK
<i>Italy</i> BB-otvor pre kľúč	10,43	12,41	374,-
PZ-otvor pre vložku	10,43	12,41	374,-
otvor - WC sada	13,97	16,63	501,-
guľa / kľučka PZ	14,17	16,86	508,-



DAFNE

povrch | F9 - nerez elox



	Cena		
	bez DPH €	s DPH €	s DPH SK
<i>Italy</i> BB-otvor pre kľúč	11,71	13,94	420,-
PZ-otvor pre vložku	11,71	13,94	420,-
otvor - WC sada	14,76	17,56	529,-
guľa / kľučka PZ	13,11	15,60	470,-



DAFNE - R

povrch | F9 - nerez elox



	Cena		
	bez DPH €	s DPH €	s DPH SK
<i>Italy</i> BB-otvor pre kľúč	11,41	13,58	409,-
PZ-otvor pre vložku	11,41	13,58	409,-
otvor - WC sada	15,34	18,26	550,-
guľa / kľučka PZ	15,84	18,85	568,-





VERONA

povrch | F1 - prírodný elox



	Cena		
	bez DPH €	s DPH €	s DPH SK
<i>Italy</i> BB-otvor pre kľúč	10,88	12,95	390,-
PZ-otvor pre vložku	10,88	12,95	390,-
otvor - WC sada	13,61	16,20	488,-
guľa / kľučka PZ	12,11	14,41	434,-

VERONA - R

povrch | F1 - prírodný elox



	Cena		
	bez DPH €	s DPH €	s DPH SK
<i>Italy</i> BB-otvor pre kľúč	10,63	12,65	381,-
PZ-otvor pre vložku	10,63	12,65	381,-
otvor - WC sada	14,20	16,90	509,-
guľa / kľučka PZ	14,29	17,00	512,-



VERONA

povrch | F4 - bronz elox



	Cena		
	bez DPH €	s DPH €	s DPH SK
<i>Italy</i> BB-otvor pre kľúč	10,88	12,95	390,-
PZ-otvor pre vložku	10,88	12,95	390,-
otvor - WC sada	13,61	16,20	488,-
guľa / kľučka PZ	12,11	14,41	434,-

VERONA - R

povrch | F4 - bronz elox



	Cena		
	bez DPH €	s DPH €	s DPH SK
<i>Italy</i> BB-otvor pre kľúč	10,63	12,65	381,-
PZ-otvor pre vložku	10,63	12,65	381,-
otvor - WC sada	14,20	16,90	509,-
guľa / kľučka PZ	14,29	17,00	512,-



VERONA

povrch | F9 - nerez elox



	Cena		
	bez DPH €	s DPH €	s DPH SK
<i>Italy</i> BB-otvor pre kľúč	11,82	14,07	424,-
PZ-otvor pre vložku	11,82	14,07	424,-
otvor - WC sada	14,84	17,66	532,-
guľa / kľučka PZ	13,17	15,67	472,-

VERONA - R

povrch | F9 - nerez elox



	Cena		
	bez DPH €	s DPH €	s DPH SK
<i>Italy</i> BB-otvor pre kľúč	11,50	13,68	412,-
PZ-otvor pre vložku	11,50	13,68	412,-
otvor - WC sada	15,45	18,39	554,-
guľa / kľučka PZ	15,90	18,92	570,-



VITO

povrch | F1 - prírodný elox



	Cena		
	bez DPH €	s DPH €	s DPH SK
BB-otvor pre kľúč	9,32	11,09	334,-
PZ-otvor pre vložku	9,32	11,09	334,-
otvor - WC sada	12,05	14,34	432,-
guľa / kľučka PZ	11,29	13,44	405,-



VITO - R

povrch | F1 - prírodný elox



	Cena		
	bez DPH €	s DPH €	s DPH SK
BB-otvor pre kľúč	9,07	10,79	325,-
PZ-otvor pre vložku	9,07	10,79	325,-
otvor - WC sada	12,64	15,04	453,-
guľa / kľučka PZ	13,53	16,10	485,-



VITO

povrch | F4 - bronz elox



	Cena		
	bez DPH €	s DPH €	s DPH SK
BB-otvor pre kľúč	9,32	11,09	334,-
PZ-otvor pre vložku	9,32	11,09	334,-
otvor - WC sada	12,05	14,34	432,-
guľa / kľučka PZ	11,29	13,44	405,-



VITO - R

povrch | F4 - bronz elox



	Cena		
	bez DPH €	s DPH €	s DPH SK
BB-otvor pre kľúč	9,07	10,79	325,-
PZ-otvor pre vložku	9,07	10,79	325,-
otvor - WC sada	12,64	15,04	453,-
guľa / kľučka PZ	13,53	16,10	485,-



VITO

povrch | F9 - nerez elox



	Cena		
	bez DPH €	s DPH €	s DPH SK
BB-otvor pre kľúč	10,24	12,18	367,-
PZ-otvor pre vložku	10,24	12,18	367,-
otvor - WC sada	13,25	15,77	475,-
guľa / kľučka PZ	12,35	14,70	443,-



VITO - R

povrch | F9 - nerez elox



	Cena		
	bez DPH €	s DPH €	s DPH SK
BB-otvor pre kľúč	9,90	11,78	355,-
PZ-otvor pre vložku	9,90	11,78	355,-
otvor - WC sada	13,87	16,50	497,-
guľa / kľučka PZ	15,12	17,99	542,-



COSLAN

povrch | F1 - prírodný elox



	Cena		
	bez DPH €	s DPH €	s DPH SK
<i>Italy</i> BB-otvor pre kľúč	10,51	12,51	377,-
PZ-otvor pre vložku	10,51	12,51	377,-
otvor - WC sada	13,25	15,77	475,-
guľa / kľučka PZ	11,88	14,14	426,-

COSLAN - R

povrch | F1 - prírodný elox



	Cena		
	bez DPH €	s DPH €	s DPH SK
<i>Italy</i> BB-otvor pre kľúč	10,27	12,22	368,-
PZ-otvor pre vložku	10,27	12,22	368,-
otvor - WC sada	13,83	16,46	496,-
guľa / kľučka PZ	14,12	16,80	506,-



COSLAN

povrch | F9 - nerez elox



	Cena		
	bez DPH €	s DPH €	s DPH SK
<i>Italy</i> BB-otvor pre kľúč	11,61	13,81	416,-
PZ-otvor pre vložku	11,61	13,81	416,-
otvor - WC sada	14,61	17,39	524,-
guľa / kľučka PZ	13,05	15,53	468,-

COSLAN - R

povrch | F9 - nerez elox



	Cena		
	bez DPH €	s DPH €	s DPH SK
<i>Italy</i> BB-otvor pre kľúč	11,27	13,41	404,-
PZ-otvor pre vložku	11,27	13,41	404,-
otvor - WC sada	15,23	18,12	546,-
guľa / kľučka PZ	15,79	18,79	566,-

COSLAN - R OVÁL

povrch | F1 - prírodný elox



	Cena		
	bez DPH €	s DPH €	s DPH SK
<i>Italy</i> otvor - PZ	11,58	13,78	415,-

COSLAN - R OVÁL

povrch | F9 - nerez elox



	Cena		
	bez DPH €	s DPH €	s DPH SK
<i>Italy</i> otvor - PZ	12,77	15,20	458,-



FAVORIT

povrch | F1 - prírodný elox



	Cena		
	bez DPH €	s DPH €	s DPH SK
<i>Italy</i> BB-otvor pre kľúč	10,99	13,08	394,-
PZ-otvor pre vložku	10,99	13,08	394,-
otvor - WC sada	13,75	16,36	493,-
guľa / kľučka PZ	12,16	14,47	436,-



FAVORIT - R

povrch | F1 - prírodný elox



	Cena		
	bez DPH €	s DPH €	s DPH SK
<i>Italy</i> BB-otvor pre kľúč	10,76	12,81	386,-
PZ-otvor pre vložku	10,76	12,81	386,-
otvor - WC sada	14,31	17,03	513,-
guľa / kľučka PZ	14,34	17,06	514,-



FAVORIT

povrch | F9 - nerez elox



	Cena		
	bez DPH €	s DPH €	s DPH SK
<i>Italy</i> BB-otvor pre kľúč	12,11	14,41	434,-
PZ-otvor pre vložku	12,11	14,41	434,-
otvor - WC sada	15,12	17,99	542,-
guľa / kľučka PZ	13,28	15,80	476,-



FAVORIT - R

povrch | F9 - nerez elox



	Cena		
	bez DPH €	s DPH €	s DPH SK
<i>Italy</i> BB-otvor pre kľúč	11,77	14,01	422,-
PZ-otvor pre vložku	11,77	14,01	422,-
otvor - WC sada	15,71	18,69	563,-
guľa / kľučka PZ	16,04	19,09	575,-



GARDA - R AOC

povrch | AOC - hliník pochrómovaný



	Cena		
	bez DPH €	s DPH €	s DPH SK
<i>Italy</i> BB-otvor pre kľúč	16,57	19,72	594,-
PZ-otvor pre vložku	16,57	19,72	594,-
otvor - WC sada	19,92	23,70	714,-
guľa / kľučka PZ	19,92	23,70	714,-



GARDA - R ANS

povrch | AOC - hliník poniklovaný



	Cena		
	bez DPH €	s DPH €	s DPH SK
<i>Italy</i> BB-otvor pre kľúč	16,57	19,72	594,-
PZ-otvor pre vložku	16,57	19,72	594,-
otvor - WC sada	19,92	23,70	714,-
guľa / kľučka PZ	19,92	23,70	714,-





GARDA

povrch | F1 - prírodný elox



	Cena		
	bez DPH €	s DPH €	s DPH SK
BB-otvor pre kľúč	9,93	11,82	356,-
PZ-otvor pre vložku	9,93	11,82	356,-
otvor - WC sada	12,64	15,04	453,-
guľa / kľučka PZ	11,63	13,84	417,-



GARDA - R

povrch | F1 - prírodný elox



	Cena		
	bez DPH €	s DPH €	s DPH SK
BB-otvor pre kľúč	9,62	11,45	345,-
PZ-otvor pre vložku	9,62	11,45	345,-
otvor - WC sada	11,63	13,84	417,-
guľa / kľučka PZ	10,46	12,45	375,-



GARDA

povrch | F4 - bronz elox



	Cena		
	bez DPH €	s DPH €	s DPH SK
BB-otvor pre kľúč	9,93	11,82	356,-
PZ-otvor pre vložku	9,93	11,82	356,-
otvor - WC sada	12,64	15,04	453,-
guľa / kľučka PZ	11,63	13,84	417,-



GARDA - R

povrch | F4 - bronz elox



	Cena		
	bez DPH €	s DPH €	s DPH SK
BB-otvor pre kľúč	9,62	11,45	345,-
PZ-otvor pre vložku	9,62	11,45	345,-
otvor - WC sada	11,63	13,84	417,-
guľa / kľučka PZ	10,46	12,45	375,-



GARDA

povrch | F9 - nerez elox



	Cena		
	bez DPH €	s DPH €	s DPH SK
BB-otvor pre kľúč	10,97	13,05	393,-
PZ-otvor pre vložku	10,97	13,05	393,-
otvor - WC sada	13,25	15,77	475,-
guľa / kľučka PZ	12,72	15,14	456,-



GARDA - R

povrch | F9 - nerez elox



	Cena		
	bez DPH €	s DPH €	s DPH SK
BB-otvor pre kľúč	10,63	12,65	381,-
PZ-otvor pre vložku	10,63	12,65	381,-
otvor - WC sada	12,52	14,90	449,-
guľa / kľučka PZ	11,63	13,84	417,-





NETUNO

povrch | F1 - prírodný elox



	Cena		
	bez DPH €	s DPH €	s DPH SK
BB-otvor pre kľúč	10,13	12,05	363,-
PZ-otvor pre vložku	10,13	12,05	363,-
otvor - WC sada	13,45	16,00	482,-
guľa / kľučka PZ	14,25	16,96	511,-

NETUNO - R

povrch | F1 - prírodný elox



	Cena		
	bez DPH €	s DPH €	s DPH SK
BB-otvor pre kľúč	9,18	10,92	329,-
PZ-otvor pre vložku	9,18	10,92	329,-
otvor - WC sada	12,72	15,14	456,-
guľa / kľučka PZ	13,55	16,13	486,-



NETUNO

povrch | F4 - bronz elox



	Cena		
	bez DPH €	s DPH €	s DPH SK
BB-otvor pre kľúč	10,13	12,05	363,-
PZ-otvor pre vložku	10,13	12,05	363,-
otvor - WC sada	13,45	16,00	482,-
guľa / kľučka PZ	14,25	16,96	511,-



NETUNO - R

povrch | F4 - bronz elox



	Cena		
	bez DPH €	s DPH €	s DPH SK
BB-otvor pre kľúč	9,18	10,92	329,-
PZ-otvor pre vložku	9,18	10,92	329,-
otvor - WC sada	12,72	15,14	456,-
guľa / kľučka PZ	13,55	16,13	486,-



NETUNO

povrch | F9 - nerez elox



	Cena		
	bez DPH €	s DPH €	s DPH SK
BB-otvor pre kľúč	11,18	13,31	401,-
PZ-otvor pre vložku	11,18	13,31	401,-
otvor - WC sada	15,01	17,86	538,-
guľa / kľučka PZ	15,84	18,85	568,-



NETUNO - R

povrch | F9 - nerez elox



	Cena		
	bez DPH €	s DPH €	s DPH SK
BB-otvor pre kľúč	10,10	12,02	362,-
PZ-otvor pre vložku	10,10	12,02	362,-
otvor - WC sada	14,06	16,73	504,-
guľa / kľučka PZ	15,84	18,85	568,-

A♦NOX® FA - HR

povrch | ANOX, F1 - prírodný elox



	Cena		
	bez DPH €	s DPH €	s DPH SK
TUPAI BB-otvor pre kľúč	19,24	22,90	690,-
PZ-otvor pre vložku	19,24	22,90	690,-
otvor - WC sada	24,21	28,81	868,-
guľa / kľučka PZ	27,48	32,70	985,-

A♦NOX® FA - HR

povrch | ANOX, F9 - nerez elox



	Cena		
	bez DPH €	s DPH €	s DPH SK
TUPAI BB-otvor pre kľúč	19,24	22,90	690,-
PZ-otvor pre vložku	19,24	22,90	690,-
otvor - WC sada	24,21	28,81	868,-
madlo / kľučka PZ	27,48	32,70	985,-

A♦NOX® NE - HR

povrch | ANOX, F1 - prírodný elox



	Cena		
	bez DPH €	s DPH €	s DPH SK
TUPAI BB-otvor pre kľúč	19,24	22,90	690,-
PZ-otvor pre vložku	19,24	22,90	690,-
otvor - WC sada	24,21	28,81	868,-
guľa / kľučka PZ	27,48	32,70	985,-

A♦NOX® NE - HR

povrch | ANOX, F9 - nerez elox



	Cena		
	bez DPH €	s DPH €	s DPH SK
TUPAI BB-otvor pre kľúč	19,24	22,90	690,-
PZ-otvor pre vložku	19,24	22,90	690,-
otvor - WC sada	24,21	28,81	868,-
madlo / kľučka PZ	27,48	32,70	985,-

A♦NOX® SW - HR

povrch | ANOX, F1 - prírodný elox



	Cena		
	bez DPH €	s DPH €	s DPH SK
TUPAI BB-otvor pre kľúč	19,24	22,90	690,-
PZ-otvor pre vložku	19,24	22,90	690,-
otvor - WC sada	24,21	28,81	868,-
guľa / kľučka PZ	27,48	32,70	985,-

A♦NOX® SW - HR

povrch | ANOX, F9 - nerez elox



	Cena		
	bez DPH €	s DPH €	s DPH SK
TUPAI BB-otvor pre kľúč	19,24	22,90	690,-
PZ-otvor pre vložku	19,24	22,90	690,-
otvor - WC sada	24,21	28,81	868,-
madlo / kľučka PZ	27,48	32,70	985,-

A♦NOX® FA - R

povrch | ANOX, F1 - prírodný elox



	Cena		
	bez DPH €	s DPH €	s DPH SK
TUPAI BB-otvor pre kľúč	14,95	17,79	536,-
PZ-otvor pre vložku	14,95	17,79	536,-
otvor - WC sada	20,84	24,80	747,-
guľa / kľučka PZ	23,79	28,31	853,-

A♦NOX® WA - R

povrch | ANOX, F1 - prírodný elox



	Cena		
	bez DPH €	s DPH €	s DPH SK
TUPAI BB-otvor pre kľúč	14,95	17,79	536,-
PZ-otvor pre vložku	14,95	17,79	536,-
otvor - WC sada	20,84	24,80	747,-
guľa / kľučka PZ	23,79	28,31	853,-

A♦NOX® NE - R

povrch | ANOX, F1 - prírodný elox



	Cena		
	bez DPH €	s DPH €	s DPH SK
TUPAI BB-otvor pre kľúč	14,95	17,79	536,-
PZ-otvor pre vložku	14,95	17,79	536,-
otvor - WC sada	20,84	24,80	747,-
guľa / kľučka PZ	23,79	28,31	853,-

A♦NOX® MO - R

povrch | ANOX, F1 - prírodný elox



	Cena		
	bez DPH €	s DPH €	s DPH SK
TUPAI BB-otvor pre kľúč	14,95	17,79	536,-
PZ-otvor pre vložku	14,95	17,79	536,-
otvor - WC sada	20,84	24,80	747,-
guľa / kľučka PZ	23,79	28,31	853,-

A♦NOX® SW - R

povrch | ANOX, F1 - prírodný elox



	Cena		
	bez DPH €	s DPH €	s DPH SK
TUPAI BB-otvor pre kľúč	14,95	17,79	536,-
PZ-otvor pre vložku	14,95	17,79	536,-
otvor - WC sada	20,84	24,80	747,-
guľa / kľučka PZ	23,79	28,31	853,-

A♦NOX® CO - R

povrch | ANOX, F1 - prírodný elox



	Cena		
	bez DPH €	s DPH €	s DPH SK
TUPAI BB-otvor pre kľúč	14,95	17,79	536,-
PZ-otvor pre vložku	14,95	17,79	536,-
otvor - WC sada	20,84	24,80	747,-
guľa / kľučka PZ	23,79	28,31	853,-

FAVORIT ŠPECIAL 2005

povrch | N - Nerez (16)



TUPAI

	Cena		
	bez DPH €	s DPH €	s DPH SK
BB-otvor pre kľúč	32,52	38,70	1166,-
PZ-otvor pre vložku	32,52	38,70	1166,-
otvor - WC sada	38,22	45,48	1370,-
guľa / kľučka PZ	43,04	51,22	1543,-
kľučka na eurookno	12,61	15,00	452,-

FAVORIT 899

povrch | N - Nerez (16)



TUPAI

	Cena		
	bez DPH €	s DPH €	s DPH SK
BB-otvor pre kľúč	21,59	25,69	774,-
PZ-otvor pre vložku	21,59	25,69	774,-
otvor - WC sada	28,23	33,59	1012,-
kľučka na eurookno	12,61	15,00	452,-

MONA ŠPECIAL 2004

povrch | N - Nerez (16)



TUPAI

	Cena		
	bez DPH €	s DPH €	s DPH SK
BB-otvor pre kľúč	32,52	38,70	1166,-
PZ-otvor pre vložku	32,52	38,70	1166,-
otvor - WC sada	38,22	45,48	1370,-
guľa / kľučka PZ	43,04	51,22	1543,-
kľučka na eurookno	12,61	15,00	452,-

MONA 898

povrch | N - Nerez (16)



TUPAI

	Cena		
	bez DPH €	s DPH €	s DPH SK
BB-otvor pre kľúč	21,59	25,69	774,-
PZ-otvor pre vložku	21,59	25,69	774,-
otvor - WC sada	28,23	33,59	1012,-
kľučka na eurookno	12,61	15,00	452,-

COSLAN ŠPECIAL 2003

povrch | N - Nerez (16)



TUPAI

	Cena		
	bez DPH €	s DPH €	s DPH SK
BB-otvor pre kľúč	32,52	38,70	1166,-
PZ-otvor pre vložku	32,52	38,70	1166,-
otvor - WC sada	38,22	45,48	1370,-
guľa / kľučka PZ	43,04	51,22	1543,-
kľučka na eurookno	12,61	15,00	452,-

COSLAN 897

povrch | N - Nerez (16)



TUPAI

	Cena		
	bez DPH €	s DPH €	s DPH SK
BB-otvor pre kľúč	21,59	25,69	774,-
PZ-otvor pre vložku	21,59	25,69	774,-
otvor - WC sada	28,23	33,59	1012,-
kľučka na eurookno	12,61	15,00	452,-

FAVORIT - R 2002 LN

povrch | LN - Leštená nerez (58)



	Cena		
	bez DPH €	s DPH €	s DPH SK
TUPAI BB-otvor pre kľúč	21,25	25,29	762,-
PZ-otvor pre vložku	21,25	25,29	762,-
otvor - WC sada	28,76	34,22	1031,-
guľa / kľučka PZ	48,90	58,19	1753,-
kľučka na eurookno	14,82	17,63	531,-

FAVORIT - R OVÁL 2072

povrch | N - Nerez (16)



	Cena		
	bez DPH €	s DPH €	s DPH SK
TUPAI PZ-otvor pre vložku	21,59	25,69	774,-
kľučka na eurookno	12,61	15,00	452,-
samostatné rozety ovál			
oválna rozeta PZ pár	4,18	4,98	150,-
oválna záslepka pár	4,18	4,98	150,-

MONA - R 2001

povrch | N - Nerez (16)



	Cena		
	bez DPH €	s DPH €	s DPH SK
TUPAI BB-otvor pre kľúč	16,57	19,72	594,-
PZ-otvor pre vložku	16,57	19,72	594,-
otvor - WC sada	23,21	27,62	832,-
guľa / kľučka PZ	36,49	43,42	1308,-
kľučka na eurookno	12,61	15,00	452,-

MONA - R OVÁL 2071

povrch | N - Nerez (16)



	Cena		
	bez DPH €	s DPH €	s DPH SK
TUPAI PZ-otvor pre vložku	21,59	25,69	774,-
kľučka na eurookno	12,61	15,00	452,-
samostatné rozety ovál			
oválna rozeta PZ pár	4,18	4,98	150,-
oválna záslepka pár	4,18	4,98	150,-

COSLAN - R 2000

povrch | N - Nerez (16)



	Cena		
	bez DPH €	s DPH €	s DPH SK
TUPAI BB-otvor pre kľúč	16,57	19,72	594,-
PZ-otvor pre vložku	16,57	19,72	594,-
otvor - WC sada	23,21	27,62	832,-
guľa / kľučka PZ	36,49	43,42	1308,-
kľučka na eurookno	12,61	15,00	452,-

COSLAN - R OVÁL 2070

povrch | N - Nerez (16)



	Cena		
	bez DPH €	s DPH €	s DPH SK
TUPAI PZ-otvor pre vložku	21,59	25,69	774,-
kľučka na eurookno	12,61	15,00	452,-
samostatné rozety ovál			
oválna rozeta PZ pár	4,18	4,98	150,-
oválna záslepka pár	4,18	4,98	150,-

FAVORIT - R 2002

povrch | N - Nerez (16)



TUPAI

Cena

	bez DPH €	s DPH €	s DPH SK
BB-otvor pre kľúč	16,57	19,72	594,-
PZ-otvor pre vložku	16,57	19,72	594,-
otvor - WC sada	23,21	27,62	832,-
guľa / kľučka PZ	36,49	43,42	1308,-
kľučka na eurookno	12,61	15,00	452,-

FAVORIT - HR 2002 Q

povrch | N - Nerez (16)



TUPAI

Cena

	bez DPH €	s DPH €	s DPH SK
BB-otvor pre kľúč	31,52	37,51	1130,-
PZ-otvor pre vložku	31,52	37,51	1130,-
otvor - WC sada	37,52	44,65	1345,-
madlo / kľučka PZ	37,52	44,65	1345,-
kľučka na eurookno	12,61	15,00	452,-

NERO - R 2233

povrch | N - Nerez (16)



TUPAI

Cena

	bez DPH €	s DPH €	s DPH SK
BB-otvor pre kľúč	16,57	19,72	594,-
PZ-otvor pre vložku	16,57	19,72	594,-
otvor - WC sada	23,21	27,62	832,-
guľa / kľučka PZ	36,49	43,42	1308,-
kľučka na eurookno	12,61	15,00	452,-

NERO - HR 2233 Q

povrch | N - Nerez (16)



TUPAI

Cena

	bez DPH €	s DPH €	s DPH SK
BB-otvor pre kľúč	31,52	37,51	1130,-
PZ-otvor pre vložku	31,52	37,51	1130,-
otvor - WC sada	37,52	44,65	1345,-
madlo / kľučka PZ	37,52	44,65	1345,-
kľučka na eurookno	12,61	15,00	452,-

SWING - R 2232

povrch | N - Nerez (16)



TUPAI

Cena

	bez DPH €	s DPH €	s DPH SK
BB-otvor pre kľúč	16,57	19,72	594,-
PZ-otvor pre vložku	16,57	19,72	594,-
otvor - WC sada	23,21	27,62	832,-
guľa / kľučka PZ	36,49	43,42	1308,-
kľučka na eurookno	12,61	15,00	452,-

SWING - HR 2232 Q

povrch | N - Nerez (16)



TUPAI

Cena

	bez DPH €	s DPH €	s DPH SK
BB-otvor pre kľúč	31,52	37,51	1130,-
PZ-otvor pre vložku	31,52	37,51	1130,-
otvor - WC sada	37,52	44,65	1345,-
madlo / kľučka PZ	37,52	44,65	1345,-
kľučka na eurookno	12,61	15,00	452,-

VEGA - R 2230

povrch | N - Nerez (16)



TUPAI

	Cena		
	bez DPH €	s DPH €	s DPH SK
BB-otvor pre kľúč	16,57	19,72	594,-
PZ-otvor pre vložku	16,57	19,72	594,-
otvor - WC sada	23,21	27,62	832,-
guľa / kľučka PZ	36,49	43,42	1308,-
kľučka na eurookno	12,61	15,00	452,-

VEGA - HR 2230 Q

povrch | N - Nerez (16)



TUPAI

	Cena		
	bez DPH €	s DPH €	s DPH SK
BB-otvor pre kľúč	31,52	37,51	1130,-
PZ-otvor pre vložku	31,52	37,51	1130,-
otvor - WC sada	37,52	44,65	1345,-
madlo / kľučka PZ	37,52	44,65	1345,-
kľučka na eurookno	12,61	15,00	452,-

ELIPSE - R

povrch | N - Nerez (16)



TUPAI

	Cena		
	bez DPH €	s DPH €	s DPH SK
BB-otvor pre kľúč	16,57	19,72	594,-
PZ-otvor pre vložku	16,57	19,72	594,-
otvor - WC sada	23,21	27,62	832,-
guľa / kľučka PZ	36,49	43,42	1308,-
kľučka na eurookno	12,61	15,00	452,-

ELIPSE - HR Q

povrch | N - Nerez (16)



TUPAI

	Cena		
	bez DPH €	s DPH €	s DPH SK
BB-otvor pre kľúč	31,52	37,51	1130,-
PZ-otvor pre vložku	31,52	37,51	1130,-
otvor - WC sada	37,52	44,65	1345,-
madlo / kľučka PZ	37,52	44,65	1345,-
kľučka na eurookno	12,61	15,00	452,-

TRENDY - R 2276

povrch | N - Nerez (16)



TUPAI

	Cena		
	bez DPH €	s DPH €	s DPH SK
BB-otvor pre kľúč	26,00	30,94	932,-
PZ-otvor pre vložku	26,00	30,94	932,-
otvor - WC sada	31,29	37,24	1122,-
guľa / kľučka PZ	43,21	51,42	1549,-

špeciálne na protipožiarne dvere

VERONA - R 2250

povrch | N - Nerez (16)



TUPAI

	Cena		
	bez DPH €	s DPH €	s DPH SK
BB-otvor pre kľúč	39,81	47,37	1427,-
PZ-otvor pre vložku	39,81	47,37	1427,-
otvor - WC sada	47,81	56,89	1714,-
guľa / kľučka PZ	47,81	56,89	1714,-
kľučka na eurookno	23,13	27,52	829,-

TORNÁDO - R

povrch | N - Nerez



	Cena		
	bez DPH €	s DPH €	s DPH SK
BB-otvor pre kľúč	29,26	34,82	1049,-
PZ-otvor pre vložku	29,26	34,82	1049,-
otvor - WC sada	38,24	45,51	1371,-
guľa / kľučka PZ	47,50	56,53	1703,-

TORNÁDO - HR Q

povrch | N - Nerez



	Cena		
	bez DPH €	s DPH €	s DPH SK
BB-otvor pre kľúč	43,49	51,75	1559,-
PZ-otvor pre vložku	43,49	51,75	1559,-
otvor - WC sada	57,88	68,88	2075,-
madlo / kľučka PZ	61,76	73,49	2214,-

DANIELA - R 2253

povrch | N - Nerez (16)



	Cena		
	bez DPH €	s DPH €	s DPH SK
BB-otvor pre kľúč	42,82	50,95	1535,-
PZ-otvor pre vložku	42,82	50,95	1535,-
otvor - WC sada	49,66	59,09	1780,-
guľa / kľučka PZ	49,66	59,09	1780,-
kľučka na eurookno	24,49	29,14	878,-

DANIELA - HR 2253 Q

povrch | N - Nerez (16)



	Cena		
	bez DPH €	s DPH €	s DPH SK
BB-otvor pre kľúč	46,13	54,90	1654,-
PZ-otvor pre vložku	46,13	54,90	1654,-
otvor - WC sada	53,78	64,00	1928,-
madlo / kľučka PZ	53,78	64,00	1928,-
kľučka na eurookno	24,49	29,14	878,-

LAGUNA - R 2254

povrch | N - Nerez (16)



	Cena		
	bez DPH €	s DPH €	s DPH SK
BB-otvor pre kľúč	42,82	50,95	1535,-
PZ-otvor pre vložku	42,82	50,95	1535,-
otvor - WC sada	49,66	59,09	1780,-
guľa / kľučka PZ	49,66	59,09	1780,-
kľučka na eurookno	24,49	29,14	878,-

LAGUNA - HR 2254 Q

povrch | N - Nerez (16)



	Cena		
	bez DPH €	s DPH €	s DPH SK
BB-otvor pre kľúč	46,13	54,90	1654,-
PZ-otvor pre vložku	46,13	54,90	1654,-
otvor - WC sada	53,78	64,00	1928,-
madlo / kľučka PZ	53,78	64,00	1928,-
kľučka na eurookno	24,49	29,14	878,-

XENA - R 2021

povrch | N - Nerez (16)



TUPAI

	Cena		
	bez DPH €	s DPH €	s DPH SK
BB-otvor pre kľúč	37,02	44,05	1327,-
PZ-otvor pre vložku	37,02	44,05	1327,-
otvor - WC sada	44,16	52,55	1583,-
guľa / kľučka PZ	44,16	52,55	1583,-
kľučka na eurookno	21,82	25,96	782,-

XENA - HR 2021 Q

povrch | N - Nerez (16)



TUPAI

	Cena		
	bez DPH €	s DPH €	s DPH SK
BB-otvor pre kľúč	40,50	48,20	1452,-
PZ-otvor pre vložku	40,50	48,20	1452,-
otvor - WC sada	48,26	57,43	1730,-
madlo / kľučka PZ	48,26	57,43	1730,-
kľučka na eurookno	21,82	25,96	782,-

DIANA - R 2251

povrch | N - Nerez (16)



TUPAI

	Cena		
	bez DPH €	s DPH €	s DPH SK
BB-otvor pre kľúč	42,82	50,95	1535,-
PZ-otvor pre vložku	42,82	50,95	1535,-
otvor - WC sada	49,66	59,09	1780,-
guľa / kľučka PZ	49,66	59,09	1780,-
kľučka na eurookno	24,49	29,14	878,-

DIANA - HR 2251 Q

povrch | N - Nerez (16)



TUPAI

	Cena		
	bez DPH €	s DPH €	s DPH SK
BB-otvor pre kľúč	46,13	54,90	1654,-
PZ-otvor pre vložku	46,13	54,90	1654,-
otvor - WC sada	53,78	64,00	1928,-
madlo / kľučka PZ	53,78	64,00	1928,-
kľučka na eurookno	24,49	29,14	878,-

POLO - R 2252

povrch | N - Nerez (16)



TUPAI

	Cena		
	bez DPH €	s DPH €	s DPH SK
BB-otvor pre kľúč	42,82	50,95	1535,-
PZ-otvor pre vložku	42,82	50,95	1535,-
otvor - WC sada	49,66	59,09	1780,-
guľa / kľučka PZ	49,66	59,09	1780,-
kľučka na eurookno	24,49	29,14	878,-

POLO - HR 2252 Q

povrch | N - Nerez (16)



TUPAI

	Cena		
	bez DPH €	s DPH €	s DPH SK
BB-otvor pre kľúč	46,13	54,90	1654,-
PZ-otvor pre vložku	46,13	54,90	1654,-
otvor - WC sada	53,78	64,00	1928,-
madlo / kľučka PZ	53,78	64,00	1928,-
kľučka na eurookno	24,49	29,14	878,-

DIAGO - R 793

povrch | OC / N - Chróm lesklý / nerez (67)



	Cena		
	bez DPH €	s DPH €	s DPH SK
BB-otvor pre kľúč	35,06	41,72	1257,-
PZ-otvor pre vložku	35,06	41,72	1257,-
otvor - WC sada	42,76	50,89	1533,-
guľa / kľučka PZ	42,76	50,89	1533,-
kľučka na eurookno	20,97	24,96	752,-

DIAGO - HR 793 Q

povrch | OC / N - Chróm lesklý / nerez (67)

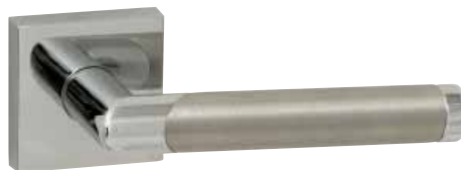

	Cena		
	bez DPH €	s DPH €	s DPH SK
BB-otvor pre kľúč	38,50	45,81	1380,-
PZ-otvor pre vložku	38,50	45,81	1380,-
otvor - WC sada	46,45	55,27	1665,-
madlo / kľučka PZ	46,45	55,27	1665,-
kľučka na eurookno	20,97	24,96	752,-

PRADO - R 792

povrch | OC / N - Chróm lesklý / nerez (67)



	Cena		
	bez DPH €	s DPH €	s DPH SK
BB-otvor pre kľúč	30,66	36,48	1099,-
PZ-otvor pre vložku	30,66	36,48	1099,-
otvor - WC sada	38,18	45,44	1369,-
guľa / kľučka PZ	38,18	45,44	1369,-
kľučka na eurookno	18,66	22,21	669,-

PRADO - HR 792 Q

povrch | OC / N - Chróm lesklý / nerez (67)



	Cena		
	bez DPH €	s DPH €	s DPH SK
BB-otvor pre kľúč	33,87	40,30	1214,-
PZ-otvor pre vložku	33,87	40,30	1214,-
otvor - WC sada	42,20	50,22	1513,-
madlo / kľučka PZ	42,20	50,22	1513,-
kľučka na eurookno	18,66	22,21	669,-

PRADO - R 792

povrch | VOC / N - Velvet chróm / nerez (81)



	Cena		
	bez DPH €	s DPH €	s DPH SK
BB-otvor pre kľúč	32,19	38,31	1154,-
PZ-otvor pre vložku	32,19	38,31	1154,-
otvor - WC sada	39,83	47,40	1428,-
guľa / kľučka PZ	39,83	47,40	1428,-
kľučka na eurookno	19,89	23,67	713,-

PRADO - HR 792 Q

povrch | VOC / N - Velvet chróm / nerez (81)



	Cena		
	bez DPH €	s DPH €	s DPH SK
BB-otvor pre kľúč	36,79	43,78	1319,-
PZ-otvor pre vložku	36,79	43,78	1319,-
otvor - WC sada	44,77	53,28	1605,-
madlo / kľučka PZ	44,77	53,28	1605,-
kľučka na eurookno	19,89	23,67	713,-

DIAGO - HRN 793 Q

povrch | N / OC / N - Chróm / nerez (123)



TUPAI

Cena

bez DPH € s DPH € s DPH SK

BB-otvor pre kľúč	38,50	45,81	1380,-
PZ-otvor pre vložku	38,50	45,81	1380,-
otvor - WC sada	46,45	55,27	1665,-
madlo / kľučka PZ	46,45	55,27	1665,-
kľučka na eurookno	20,97	24,96	752,-

BREST - HRN 2031 A / Q

povrch | N / OC / N - Chróm / nerez (123)



TUPAI

Cena

bez DPH € s DPH € s DPH SK

BB-otvor pre kľúč	44,77	53,28	1605,-
PZ-otvor pre vložku	44,77	53,28	1605,-
otvor - WC sada	51,41	61,18	1843,-
madlo / kľučka PZ	54,73	65,13	1962,-
kľučka na eurookno	23,15	27,55	830,-

PRADO - HRN 792 Q

povrch | N / OC / N - Chróm / nerez (123)



TUPAI

Cena

bez DPH € s DPH € s DPH SK

BB-otvor pre kľúč	33,87	40,30	1214,-
PZ-otvor pre vložku	33,87	40,30	1214,-
otvor - WC sada	42,20	50,22	1513,-
madlo / kľučka PZ	42,20	50,22	1513,-
kľučka na eurookno	18,66	22,21	669,-

DACAPO - HRN 791 A / Q

povrch | N / OC / N - Chróm / nerez (123)



TUPAI

Cena

bez DPH € s DPH € s DPH SK

BB-otvor pre kľúč	34,00	40,46	1219,-
PZ-otvor pre vložku	34,00	40,46	1219,-
otvor - WC sada	42,54	50,62	1525,-
madlo / kľučka PZ	42,54	50,62	1525,-
kľučka na eurookno	16,26	19,35	583,-

ADONIS - R

povrch | OC / N - Chróm lesklý / nerez



Cena

bez DPH € s DPH € s DPH SK

BB-otvor pre kľúč	38,75	46,11	1389,-
PZ-otvor pre vložku	38,75	46,11	1389,-
otvor - WC sada	51,24	60,98	1837,-
guľa / kľučka PZ	64,77	77,08	2322,-

DACAPO - R 791 / A

povrch | OC / N - Chróm lesklý / nerez (67)



TUPAI

Cena

bez DPH € s DPH € s DPH SK

BB-otvor pre kľúč	24,57	29,24	881,-
PZ-otvor pre vložku	24,57	29,24	881,-
otvor - WC sada	29,85	35,52	1070,-
guľa / kľučka PZ	34,87	41,49	1250,-
kľučka na eurookno	16,26	19,35	583,-

MARENA - R 794

povrch | OC / N - Chróm lesklý / nerez (67)



	Cena		
	bez DPH €	s DPH €	s DPH SK
BB-otvor pre kľúč	28,23	33,59	1012,-
PZ-otvor pre vložku	28,23	33,59	1012,-
otvor - WC sada	36,18	43,05	1297,-
guľa / kľučka PZ	37,18	44,25	1333,-
kľučka na eurookno	17,93	21,34	643,-

MARENA - HR 794 Q

povrch | OC / N - Chróm lesklý / nerez (67)



	Cena		
	bez DPH €	s DPH €	s DPH SK
BB-otvor pre kľúč	33,17	39,47	1189,-
PZ-otvor pre vložku	33,17	39,47	1189,-
otvor - WC sada	39,50	47,00	1416,-
madlo / kľučka PZ	50,80	60,45	1821,-
kľučka na eurookno	17,93	21,34	643,-

MARENA - R 794

povrch | VOC / N - Velvet chróm / nerez (81)



	Cena		
	bez DPH €	s DPH €	s DPH SK
BB-otvor pre kľúč	32,52	38,70	1166,-
PZ-otvor pre vložku	32,52	38,70	1166,-
otvor - WC sada	41,50	49,39	1488,-
guľa / kľučka PZ	42,48	50,55	1523,-
kľučka na eurookno	19,86	23,63	712,-

MARENA - HR 794 Q

povrch | VOC / N - Velvet chróm / nerez (81)

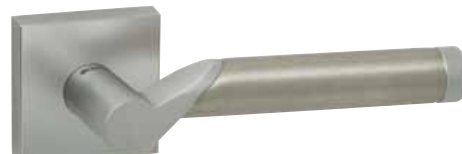

	Cena		
	bez DPH €	s DPH €	s DPH SK
BB-otvor pre kľúč	34,87	41,49	1250,-
PZ-otvor pre vložku	34,87	41,49	1250,-
otvor - WC sada	42,82	50,95	1535,-
madlo / kľučka PZ	50,80	60,45	1821,-
kľučka na eurookno	19,86	23,63	712,-

MARENA - R 794

povrch | VONS / NL - Nikel velvet / nerez lesklá (105)

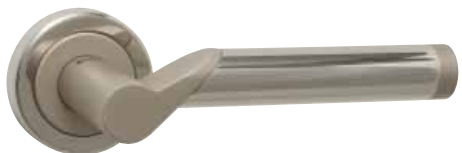

	Cena		
	bez DPH €	s DPH €	s DPH SK
BB-otvor pre kľúč	39,81	47,37	1427,-
PZ-otvor pre vložku	39,81	47,37	1427,-
otvor - WC sada	48,09	57,23	1724,-
guľa / kľučka PZ	48,09	57,23	1724,-
kľučka na eurookno	23,21	27,62	832,-

MARENA - HRN 794 Q

povrch | N / OC / N - Chróm / nerez (123)



	Cena		
	bez DPH €	s DPH €	s DPH SK
BB-otvor pre kľúč	33,17	39,47	1189,-
PZ-otvor pre vložku	33,17	39,47	1189,-
otvor - WC sada	39,50	47,00	1416,-
madlo / kľučka PZ	50,80	60,45	1821,-
kľučka na eurookno	17,93	21,34	643,-

MARENA - R 794

povrch | OLV / N - Mosadz leštená a lakovaná / nerez (65)



TUPAI

Cena

	bez DPH €	s DPH €	s DPH SK
BB-otvor pre kľúč	39,81	47,37	1427,-
PZ-otvor pre vložku	39,81	47,37	1427,-
otvor - WC sada	48,09	57,23	1724,-
guľa / kľučka PZ	48,09	57,23	1724,-
kľučka na eurookno	23,21	27,62	832,-

MARENA - R 794

povrch | OLS / N - Mosadz brúsená a lakovaná/nerez (68)



TUPAI

Cena

	bez DPH €	s DPH €	s DPH SK
BB-otvor pre kľúč	39,81	47,37	1427,-
PZ-otvor pre vložku	39,81	47,37	1427,-
otvor - WC sada	48,09	57,23	1724,-
guľa / kľučka PZ	48,09	57,23	1724,-
kľučka na eurookno	23,21	27,62	832,-

BARON - R

povrch | OC / B - Chróm lesklý / čierny



Cena

	bez DPH €	s DPH €	s DPH SK
BB-otvor pre kľúč	39,50	47,00	1416,-
PZ-otvor pre vložku	39,50	47,00	1416,-
otvor - WC sada	50,02	59,52	1793,-
guľa / kľučka PZ	62,26	74,09	2232,-

DUKON - R

povrch | OC / B - Chróm lesklý / čierny



Cena

	bez DPH €	s DPH €	s DPH SK
BB-otvor pre kľúč	39,50	47,00	1416,-
PZ-otvor pre vložku	39,50	47,00	1416,-
otvor - WC sada	50,02	59,52	1793,-
guľa / kľučka PZ	62,26	74,09	2232,-

BALI - R

povrch | OC / ONS - Chróm / nikel brúsený



Cena

	bez DPH €	s DPH €	s DPH SK
BB-otvor pre kľúč	34,76	41,36	1246,-
PZ-otvor pre vložku	34,76	41,36	1246,-
otvor - WC sada	44,74	53,24	1604,-
guľa / kľučka PZ	62,26	74,09	2232,-
kľučka na eurookno	16,13	19,19	578,-

BALI - HRN Q

povrch | OC / ONS - Chróm / nikel brúsený



Cena

	bez DPH €	s DPH €	s DPH SK
BB-otvor pre kľúč	46,97	55,90	1684,-
PZ-otvor pre vložku	46,97	55,90	1684,-
otvor - WC sada	62,26	74,09	2232,-
madlo / kľučka PZ	81,87	97,42	2935,-
kľučka na eurookno	16,13	19,19	578,-

séria | NEREZ / MOSADZ alebo ZLIATINA ZINKU (kombinované)

META - R 795

povrch | OC / N - Chróm lesklý / nerez (67)



	Cena		
	bez DPH €	s DPH €	s DPH SK
BB-otvor pre kľúč	33,17	39,47	1189,-
PZ-otvor pre vložku	33,17	39,47	1189,-
otvor - WC sada	39,81	47,37	1427,-
guľa / kľučka PZ	43,13	51,32	1546,-
kľučka na eurookno	20,08	23,90	720,-

META - HR 795 Q

povrch | OC / N - Chróm lesklý / nerez (67)



	Cena		
	bez DPH €	s DPH €	s DPH SK
BB-otvor pre kľúč	36,51	43,45	1309,-
PZ-otvor pre vložku	36,51	43,45	1309,-
otvor - WC sada	41,70	49,62	1495,-
madlo / kľučka PZ	48,09	57,23	1724,-
kľučka na eurookno	20,08	23,90	720,-

META - R 795

povrch | VOC / N - Velvet chróm / nerez (81)



	Cena		
	bez DPH €	s DPH €	s DPH SK
BB-otvor pre kľúč	36,51	43,45	1309,-
PZ-otvor pre vložku	36,51	43,45	1309,-
otvor - WC sada	41,70	49,62	1495,-
guľa / kľučka PZ	41,70	49,62	1495,-
kľučka na eurookno	21,65	25,76	776,-

META - HR 795 Q

povrch | VOC / N - Velvet chróm / nerez (81)



	Cena		
	bez DPH €	s DPH €	s DPH SK
BB-otvor pre kľúč	39,81	47,37	1427,-
PZ-otvor pre vložku	39,81	47,37	1427,-
otvor - WC sada	46,45	55,27	1665,-
madlo / kľučka PZ	48,09	57,23	1724,-
kľučka na eurookno	21,65	25,76	776,-

META 2055

povrch | OC / N - Chróm lesklý / nerez (67)



	Cena		
	bez DPH €	s DPH €	s DPH SK
BB-otvor pre kľúč	43,13	51,32	1546,-
PZ-otvor pre vložku	43,13	51,32	1546,-
otvor - WC sada	48,14	57,28	1726,-
guľa / kľučka PZ	48,14	57,28	1726,-
kľučka na eurookno	20,08	23,90	720,-

META - HRN 795 Q

povrch | N / OC / N - Nerez/chróm lesklý/nerez (123)

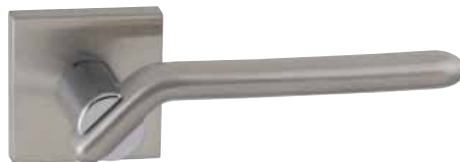

	Cena		
	bez DPH €	s DPH €	s DPH SK
BB-otvor pre kľúč	36,51	43,45	1309,-
PZ-otvor pre vložku	36,51	43,45	1309,-
otvor - WC sada	41,70	49,62	1495,-
madlo / kľučka PZ	48,09	57,23	1724,-
kľučka na eurookno	20,08	23,90	720,-

ATZ 1 - HR 2277 Q

povrch | OC / N - Chróm lesklý / nerez (67)

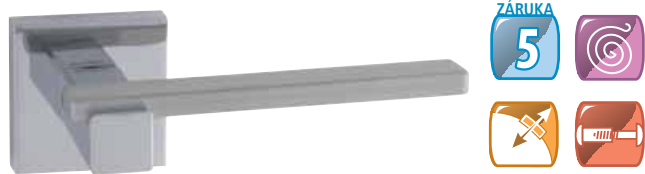

	Cena		
	bez DPH €	s DPH €	s DPH SK
BB-otvor pre kľúč	61,06	72,66	2189,-
PZ-otvor pre vložku	61,06	72,66	2189,-
otvor - WC sada	68,31	81,29	2449,-
madlo / kľučka PZ	73,05	86,93	2619,-
kľučka na eurookno	32,89	39,14	1179,-

ATZ 1 - HRN 2277 Q

povrch | N / OC / N - Nerez/chróm lesklý/nerez (123)



	Cena		
	bez DPH €	s DPH €	s DPH SK
BB-otvor pre kľúč	61,06	72,66	2189,-
PZ-otvor pre vložku	61,06	72,66	2189,-
otvor - WC sada	68,31	81,29	2449,-
madlo / kľučka PZ	73,05	86,93	2619,-
kľučka na eurookno	32,89	39,14	1179,-

ATZ 2 - HR 2278 Q

povrch | OC / N - Chróm lesklý / nerez (67)



	Cena		
	bez DPH €	s DPH €	s DPH SK
BB-otvor pre kľúč	61,06	72,66	2189,-
PZ-otvor pre vložku	61,06	72,66	2189,-
otvor - WC sada	68,31	81,29	2449,-
madlo / kľučka PZ	73,05	86,93	2619,-
kľučka na eurookno	32,89	39,14	1179,-

ATZ 2 - HRN 2278 Q

povrch | N / OC / N - Nerez/chróm lesklý/nerez (123)

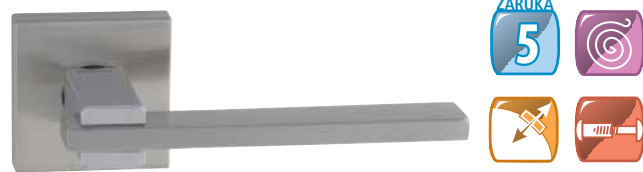

	Cena		
	bez DPH €	s DPH €	s DPH SK
BB-otvor pre kľúč	61,06	72,66	2189,-
PZ-otvor pre vložku	61,06	72,66	2189,-
otvor - WC sada	68,31	81,29	2449,-
madlo / kľučka PZ	73,05	86,93	2619,-
kľučka na eurookno	32,89	39,14	1179,-



preskrutkovanie
cez dvere

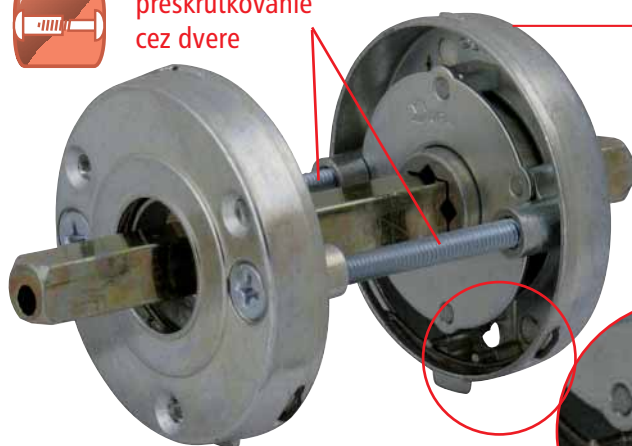

TUPAI

TUPAI rozetová mechanika

vzhľadom na doterajšie skúsenosti a požiadavky zákazníkov, sme pri kľúčoch značky TUPAI v spolupráci s výrobcom zdokonalili systém uchytenia krytky rozety špeciálnym mechanickým pružinovým klikom, ktorý Vám uľahčí namontovať a opätovne demontovať krytku bez poškodenia. V mechanike sa nachádza pružinka, ktorá dotláča krytku rozety a zabraňuje jej vypadnutiu. Pri demontáži krytky stačí jednoducho zasunúť plochý skrutkovač na príslušné miesto a miernym pootočením ju bez poškodenia vylúpnúť.



klik

nové od 2009

BREST - R 2031 / A

povrch | OC / N - Chróm lesklý / nerez (67)



	Cena		
	bez DPH €	s DPH €	s DPH SK
BB-otvor pre kľúč	39,81	47,37	1427,-
PZ-otvor pre vložku	39,81	47,37	1427,-
otvor - WC sada	46,45	55,27	1665,-
guľa / kľučka PZ	46,45	55,27	1665,-
kľučka na eurookno	23,15	27,55	830,-

BREST - HR 2031 / A Q

povrch | OC / N - Chróm lesklý / nerez (67)



	Cena		
	bez DPH €	s DPH €	s DPH SK
BB-otvor pre kľúč	44,77	53,28	1605,-
PZ-otvor pre vložku	44,77	53,28	1605,-
otvor - WC sada	51,41	61,18	1843,-
madlo / kľučka PZ	54,73	65,13	1962,-
kľučka na eurookno	23,15	27,55	830,-

BREST - R 2030 / B

povrch | OC / N - Chróm lesklý / nerez (67)



	Cena		
	bez DPH €	s DPH €	s DPH SK
BB-otvor pre kľúč	45,13	53,71	1618,-
PZ-otvor pre vložku	45,13	53,71	1618,-
otvor - WC sada	51,77	61,61	1856,-
guľa / kľučka PZ	51,77	61,61	1856,-
kľučka na eurookno	25,52	30,37	915,-

BREST - HR 2030 / B Q

povrch | OC / N - Chróm lesklý / nerez (67)



	Cena		
	bez DPH €	s DPH €	s DPH SK
BB-otvor pre kľúč	48,14	57,29	1726,-
PZ-otvor pre vložku	48,14	57,29	1726,-
otvor - WC sada	55,09	65,56	1975,-
madlo / kľučka PZ	56,43	67,15	2023,-
kľučka na eurookno	25,52	30,37	915,-

BREST - R 2040 / C

povrch | OC / N - Chróm lesklý / nerez (67)



	Cena		
	bez DPH €	s DPH €	s DPH SK
BB-otvor pre kľúč	45,13	53,71	1618,-
PZ-otvor pre vložku	45,13	53,71	1618,-
otvor - WC sada	51,77	61,61	1856,-
guľa / kľučka PZ	51,77	61,61	1856,-
kľučka na eurookno	25,52	30,37	915,-

BREST - HR 2040 / C Q

povrch | OC / N - Chróm lesklý / nerez (67)



	Cena		
	bez DPH €	s DPH €	s DPH SK
BB-otvor pre kľúč	48,14	57,29	1726,-
PZ-otvor pre vložku	48,14	57,29	1726,-
otvor - WC sada	55,09	65,56	1975,-
madlo / kľučka PZ	56,43	67,15	2023,-
kľučka na eurookno	25,52	30,37	915,-

BREST - R 2031 / A

povrch | VOC / N - Velvet chróm / nerez (81)



	Cena		
	bez DPH €	s DPH €	s DPH SK
BB-otvor pre kľúč	39,81	47,37	1427,-
PZ-otvor pre vložku	39,81	47,37	1427,-
otvor - WC sada	46,45	55,27	1665,-
guľa / kľučka PZ	46,45	55,27	1665,-
kľučka na eurookno	23,15	27,55	830,-

BREST - HR 2031 / A Q

povrch | VOC / N - Velvet chróm / nerez (81)

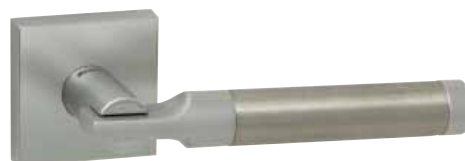

	Cena		
	bez DPH €	s DPH €	s DPH SK
BB-otvor pre kľúč	42,82	50,95	1535,-
PZ-otvor pre vložku	42,82	50,95	1535,-
otvor - WC sada	49,76	59,22	1784,-
madlo / kľučka PZ	51,41	61,18	1843,-
kľučka na eurookno	23,15	27,55	830,-

BREST - R 2030 / B

povrch | VOC / N - Velvet chróm / nerez (81)



	Cena		
	bez DPH €	s DPH €	s DPH SK
BB-otvor pre kľúč	45,13	53,71	1618,-
PZ-otvor pre vložku	45,13	53,71	1618,-
otvor - WC sada	51,77	61,61	1856,-
guľa / kľučka PZ	51,77	61,61	1856,-
kľučka na eurookno	25,52	30,37	915,-

BREST - HR 2030 / B Q

povrch | VOC / N - Velvet chróm / nerez (81)

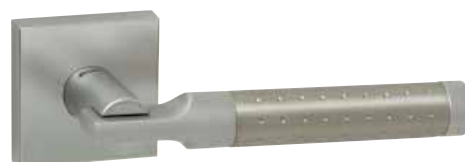

	Cena		
	bez DPH €	s DPH €	s DPH SK
BB-otvor pre kľúč	48,14	57,29	1726,-
PZ-otvor pre vložku	48,14	57,29	1726,-
otvor - WC sada	55,09	65,56	1975,-
madlo / kľučka PZ	56,43	67,15	2023,-
kľučka na eurookno	25,52	30,37	915,-

BREST - R 2040 / C

povrch | VOC / N - Velvet chróm / nerez (81)



	Cena		
	bez DPH €	s DPH €	s DPH SK
BB-otvor pre kľúč	45,13	53,71	1618,-
PZ-otvor pre vložku	45,13	53,71	1618,-
otvor - WC sada	51,77	61,61	1856,-
guľa / kľučka PZ	51,77	61,61	1856,-
kľučka na eurookno	25,52	30,37	915,-

BREST - HR 2040 / C Q

povrch | VOC / N - Velvet chróm / nerez (81)



	Cena		
	bez DPH €	s DPH €	s DPH SK
BB-otvor pre kľúč	48,14	57,29	1726,-
PZ-otvor pre vložku	48,14	57,29	1726,-
otvor - WC sada	55,09	65,56	1975,-
madlo / kľučka PZ	56,43	67,15	2023,-
kľučka na eurookno	25,52	30,37	915,-

CLERMONT - R 2027 / A

povrch | OC / N - Chróm / nerez (67)



	Cena		
	bez DPH €	s DPH €	s DPH SK
TUPAI BB-otvor pre kľúč	39,81	47,37	1427,-
PZ-otvor pre vložku	39,81	47,37	1427,-
otvor - WC sada	46,45	55,27	1665,-
guľa / kľučka PZ	46,45	55,27	1665,-
kľučka na eurookno	23,15	27,55	830,-

CLERMONT - HR 2027 / A Q

povrch | OC / N - Chróm / nerez (67)



	Cena		
	bez DPH €	s DPH €	s DPH SK
TUPAI BB-otvor pre kľúč	42,82	50,95	1535,-
PZ-otvor pre vložku	42,82	50,95	1535,-
otvor - WC sada	49,76	59,22	1784,-
madlo / kľučka PZ	51,41	61,18	1843,-
kľučka na eurookno	23,15	27,55	830,-

CLERMONT - R 2026 / B

povrch | OC / N - Chróm / nerez (67)



	Cena		
	bez DPH €	s DPH €	s DPH SK
TUPAI BB-otvor pre kľúč	45,13	53,71	1618,-
PZ-otvor pre vložku	45,13	53,71	1618,-
otvor - WC sada	51,77	61,61	1856,-
guľa / kľučka PZ	51,77	61,61	1856,-
kľučka na eurookno	25,52	30,37	915,-

CLERMONT - HR 2026 / B Q

povrch | OC / N - Chróm / nerez (67)



	Cena		
	bez DPH €	s DPH €	s DPH SK
TUPAI BB-otvor pre kľúč	48,14	57,29	1726,-
PZ-otvor pre vložku	48,14	57,29	1726,-
otvor - WC sada	55,09	65,56	1975,-
madlo / kľučka PZ	56,43	67,15	2023,-
kľučka na eurookno	25,52	30,37	915,-

CLERMONT - R 2038 / C

povrch | OC / N - Chróm / nerez (67)



	Cena		
	bez DPH €	s DPH €	s DPH SK
TUPAI BB-otvor pre kľúč	45,13	53,71	1618,-
PZ-otvor pre vložku	45,13	53,71	1618,-
otvor - WC sada	51,77	61,61	1856,-
guľa / kľučka PZ	51,77	61,61	1856,-
kľučka na eurookno	25,52	30,37	915,-

CLERMONT - HR 2038 / C Q

povrch | OC / N - Chróm / nerez (67)



	Cena		
	bez DPH €	s DPH €	s DPH SK
TUPAI BB-otvor pre kľúč	48,14	57,29	1726,-
PZ-otvor pre vložku	48,14	57,29	1726,-
otvor - WC sada	55,09	65,56	1975,-
madlo / kľučka PZ	56,43	67,15	2023,-
kľučka na eurookno	25,52	30,37	915,-

CLERMONT - R 2027 / A

povrch | VOC / N - Velvet chróm / nerez (81)



	Cena		
	bez DPH €	s DPH €	s DPH SK
TUPAI BB-otvor pre kľúč	39,81	47,37	1427,-
PZ-otvor pre vložku	39,81	47,37	1427,-
otvor - WC sada	46,45	55,27	1665,-
guľa / kľučka PZ	46,45	55,27	1665,-
kľučka na eurookno	23,15	27,55	830,-

CLERMONT - HR 2027 / A Q

povrch | VOC / N - Velvet chróm / nerez (81)



	Cena		
	bez DPH €	s DPH €	s DPH SK
TUPAI BB-otvor pre kľúč	42,82	50,95	1535,-
PZ-otvor pre vložku	42,82	50,95	1535,-
otvor - WC sada	49,76	59,22	1784,-
madlo / kľučka PZ	51,41	61,18	1843,-
kľučka na eurookno	23,15	27,55	830,-

CLERMONT - R 2026 / B

povrch | VOC / N - Velvet chróm / nerez (81)



	Cena		
	bez DPH €	s DPH €	s DPH SK
TUPAI BB-otvor pre kľúč	45,13	53,71	1618,-
PZ-otvor pre vložku	45,13	53,71	1618,-
otvor - WC sada	51,77	61,61	1856,-
guľa / kľučka PZ	51,77	61,61	1856,-
kľučka na eurookno	25,52	30,37	915,-

CLERMONT - HR 2026 / B Q

povrch | VOC / N - Velvet chróm / nerez (81)



	Cena		
	bez DPH €	s DPH €	s DPH SK
TUPAI BB-otvor pre kľúč	48,14	57,29	1726,-
PZ-otvor pre vložku	48,14	57,29	1726,-
otvor - WC sada	55,09	65,56	1975,-
madlo / kľučka PZ	56,43	67,15	2023,-
kľučka na eurookno	25,52	30,37	915,-

CLERMONT - R 2038 / C

povrch | VOC / N - Velvet chróm / nerez (81)



	Cena		
	bez DPH €	s DPH €	s DPH SK
TUPAI BB-otvor pre kľúč	45,13	53,71	1618,-
PZ-otvor pre vložku	45,13	53,71	1618,-
otvor - WC sada	51,77	61,61	1856,-
guľa / kľučka PZ	51,77	61,61	1856,-
kľučka na eurookno	25,52	30,37	915,-

CLERMONT - HR 2038 / C Q

povrch | VOC / N - Velvet chróm / nerez (81)



	Cena		
	bez DPH €	s DPH €	s DPH SK
TUPAI BB-otvor pre kľúč	48,14	57,29	1726,-
PZ-otvor pre vložku	48,14	57,29	1726,-
otvor - WC sada	55,09	65,56	1975,-
madlo / kľučka PZ	56,43	67,15	2023,-
kľučka na eurookno	25,52	30,37	915,-

DENVER - R

povrch | OC / ONS - Chróm lesklý / nikel brúsený



	Cena		
	bez DPH €	s DPH €	s DPH SK
BB-otvor pre kľúč	34,76	41,36	1246,-
PZ-otvor pre vložku	34,76	41,36	1246,-
sada s WC kľúčom	44,74	53,24	1604,-
guľa / kľučka PZ	62,26	74,09	2232,-

VIKTORIA - R 2032 / A

povrch | OC / N - Chróm / nerez (67)



	Cena		
	bez DPH €	s DPH €	s DPH SK
BB-otvor pre kľúč	39,81	47,37	1427,-
PZ-otvor pre vložku	39,81	47,37	1427,-
sada s WC kľúčom	46,45	55,27	1665,-
guľa / kľučka PZ	46,45	55,27	1665,-
klučka na eurookno	23,13	27,52	829,-

VIRGINIA - R 2221

povrch | OC / N - Chróm / nerez (67)



	Cena		
	bez DPH €	s DPH €	s DPH SK
BB-otvor pre kľúč	42,82	50,95	1535,-
PZ-otvor pre vložku	42,82	50,95	1535,-
sada s WC kľúčom	49,45	58,85	1773,-
guľa / kľučka PZ	49,45	58,85	1773,-
klučka na eurookno	24,49	29,14	878,-

VIKTORIA - R 2042 / B

povrch | OC / N - Chróm / nerez (67)



	Cena		
	bez DPH €	s DPH €	s DPH SK
BB-otvor pre kľúč	44,16	52,55	1583,-
PZ-otvor pre vložku	44,16	52,55	1583,-
sada s WC kľúčom	51,24	60,98	1837,-
guľa / kľučka PZ	51,24	60,98	1837,-
klučka na eurookno	25,10	29,87	900,-

VIRGINIA - R 2221

povrch | VOC / N - Velvet chróm / nerez (81)



	Cena		
	bez DPH €	s DPH €	s DPH SK
BB-otvor pre kľúč	42,82	50,95	1535,-
PZ-otvor pre vložku	42,82	50,95	1535,-
sada s WC kľúčom	49,45	58,85	1773,-
guľa / kľučka PZ	49,45	58,85	1773,-
klučka na eurookno	24,49	29,14	878,-

VIKTORIA - R 2041 / C

povrch | OC / N - Chróm / nerez (67)



	Cena		
	bez DPH €	s DPH €	s DPH SK
BB-otvor pre kľúč	44,16	52,55	1583,-
PZ-otvor pre vložku	44,16	52,55	1583,-
sada s WC kľúčom	51,24	60,98	1837,-
guľa / kľučka PZ	51,24	60,98	1837,-
klučka na eurookno	25,10	29,87	900,-

šablóna je určená na vrtanie montážnych otvorov pre rozetové kľučky. Zabezpečuje presné vyvrtanie otvorov.

	Cena		
	bez DPH €	s DPH €	s DPH SK
neruzová šablóna	6,64	7,90	238,-

Postupy pri vrtaní

BB 72 a PZ 72

Ak chcete navŕtať otvory pre rozetovú kľučku BB alebo PZ s roztečou zámku 72mm, zaveste šablónu na štvorhran kľučky štvorcovým otvorom na šablóne označeným značkou „N° 1“ a vyvrtajte 2 diery vodorovne vo vrchnej časti označenej „N° 1“ a 2 diery v spodnej časti označenej písmenom „A“.

WC 72

Ak chcete navŕtať otvory pre rozetovú kľučku WC s roztečou zámku 72mm, zaveste šablónu na štvorhran kľučky štvorcovým otvorom na šablóne označeným značkou „N° 3“ a vyvrtajte 2 diery vodorovne vo vrchnej časti označenej „N° 3“ a 2 diery v spodnej časti označenej písmenom „C“.

BB 90 a PZ 90

Ak chcete navŕtať otvory pre rozetovú kľučku BB alebo PZ s roztečou zámku 90mm, zaveste šablónu na štvorhran kľučky štvorcovým otvorom na šablóne označeným značkou „N° 2“ a vyvrtajte 2 diery vodorovne vo vrchnej časti označenej „N° 2“ a 2 diery v spodnej časti označenej písmenom „D“.

WC 90

Ak chcete navŕtať otvory pre rozetovú kľučku WC s roztečou zámku 90mm, zaveste šablónu na štvorhran kľučky štvorcovým otvorom na šablóne označeným značkou „N° 1“ a vyvrtajte 2 diery vodorovne vo vrchnej časti označenej „N° 1“ a 2 diery v spodnej časti označenej písmenom „B“.

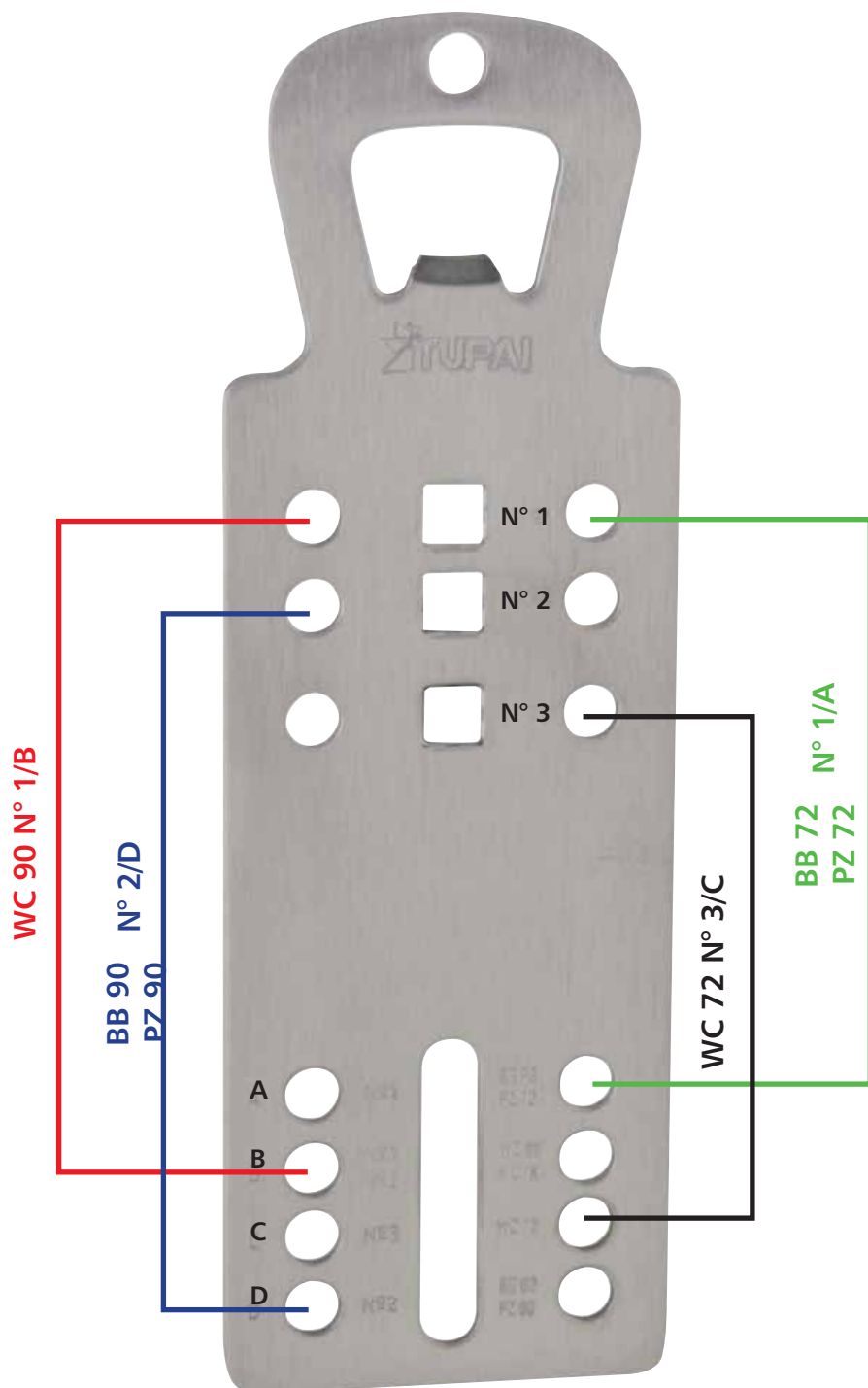

BB



PZ



WC





THEMA

povrch | OC - Chrom lesklý



<i>Made in Italy</i>	Cena		
	bez DPH €	s DPH €	s DPH SK
BB-otvor pre kľúč	13,00	15,47	466,-
PZ-otvor pre vložku	13,00	15,47	466,-
sada s WC kľúčom	21,01	25,00	753,-
guľa / kľučka PZ	21,50	25,59	771,-
kľučka na eurookno	7,50	8,93	269,-



THEMA - R

povrch | OC - Chrom lesklý



<i>Made in Italy</i>	Cena		
	bez DPH €	s DPH €	s DPH SK
BB-otvor pre kľúč	13,00	15,47	466,-
PZ-otvor pre vložku	13,00	15,47	466,-
sada s WC kľúčom	21,01	25,00	753,-
guľa / kľučka PZ	21,50	25,59	771,-
kľučka na eurookno	7,50	8,93	269,-



THEMA

povrch | OCS - Chrom brúsený



<i>Made in Italy</i>	Cena		
	bez DPH €	s DPH €	s DPH SK
BB-otvor pre kľúč	13,00	15,47	466,-
PZ-otvor pre vložku	13,00	15,47	466,-
sada s WC kľúčom	21,01	25,00	753,-
guľa / kľučka PZ	21,50	25,59	771,-
kľučka na eurookno	7,50	8,93	269,-



THEMA - R

povrch | OCS - Chrom brúsený



<i>Made in Italy</i>	Cena		
	bez DPH €	s DPH €	s DPH SK
BB-otvor pre kľúč	13,00	15,47	466,-
PZ-otvor pre vložku	13,00	15,47	466,-
sada s WC kľúčom	21,01	25,00	753,-
guľa / kľučka PZ	21,50	25,59	771,-
kľučka na eurookno	7,50	8,93	269,-



THEMA

povrch | ONS - Nikel brúsený



<i>Made in Italy</i>	Cena		
	bez DPH €	s DPH €	s DPH SK
BB-otvor pre kľúč	13,00	15,47	466,-
PZ-otvor pre vložku	13,00	15,47	466,-
sada s WC kľúčom	21,01	25,00	753,-
guľa / kľučka PZ	21,50	25,59	771,-
kľučka na eurookno	7,50	8,93	269,-



THEMA - R

povrch | ONS - Nikel brúsený



<i>Made in Italy</i>	Cena		
	bez DPH €	s DPH €	s DPH SK
BB-otvor pre kľúč	13,00	15,47	466,-
PZ-otvor pre vložku	13,00	15,47	466,-
sada s WC kľúčom	21,01	25,00	753,-
guľa / kľučka PZ	21,50	25,59	771,-
kľučka na eurookno	7,50	8,93	269,-



ALEX

povrch | OCS - Chrom brúsený



<i>Made in Italy</i>	Cena		
	bez DPH €	s DPH €	s DPH SK
BB-otvor pre kľúč	12,52	14,90	449,-
PZ-otvor pre vložku	12,52	14,90	449,-
sada s WC kľúčom	19,50	23,20	699,-
guľa / kľučka PZ	21,50	25,59	771,-
kľučka na eurookno	7,50	8,93	269,-



ALEX - R

povrch | OCS - Chrom brúsený



<i>Made in Italy</i>	Cena		
	bez DPH €	s DPH €	s DPH SK
BB-otvor pre kľúč	12,52	14,90	449,-
PZ-otvor pre vložku	12,52	14,90	449,-
sada s WC kľúčom	19,50	23,20	699,-
guľa / kľučka PZ	21,50	25,59	771,-
kľučka na eurookno	7,50	8,93	269,-



ALEX

povrch | ONS - Nikel brúsený



<i>Made in Italy</i>	Cena		
	bez DPH €	s DPH €	s DPH SK
BB-otvor pre kľúč	12,52	14,90	449,-
PZ-otvor pre vložku	12,52	14,90	449,-
sada s WC kľúčom	19,50	23,20	699,-
guľa / kľučka PZ	21,50	25,59	771,-
kľučka na eurookno	7,50	8,93	269,-



ALEX - R

povrch | ONS - Nikel brúsený



<i>Made in Italy</i>	Cena		
	bez DPH €	s DPH €	s DPH SK
BB-otvor pre kľúč	12,52	14,90	449,-
PZ-otvor pre vložku	12,52	14,90	449,-
sada s WC kľúčom	19,50	23,20	699,-
guľa / kľučka PZ	21,50	25,59	771,-
kľučka na eurookno	7,50	8,93	269,-





MILENA

povrch | OLV - Mosadz leštená a lakovaná



	Cena		
	bez DPH €	s DPH €	s DPH SK
BB-otvor pre kľúč	15,01	17,86	538,-
PZ-otvor pre vložku	15,01	17,86	538,-
sada s WC kľúčom	21,25	25,29	762,-
guľa / kľučka PZ	20,61	24,53	739,-



MILENA - R

povrch | OLV - Mosadz leštená a lakovaná



	Cena		
	bez DPH €	s DPH €	s DPH SK
BB-otvor pre kľúč	12,13	14,44	435,-
PZ-otvor pre vložku	12,13	14,44	435,-
sada s WC kľúčom	17,13	20,38	614,-
guľa / kľučka PZ	18,10	21,54	649,-



MILENA

povrch | OGR - Bronz česaný



	Cena		
	bez DPH €	s DPH €	s DPH SK
BB-otvor pre kľúč	15,01	17,86	538,-
PZ-otvor pre vložku	15,01	17,86	538,-
sada s WC kľúčom	21,25	25,29	762,-
guľa / kľučka PZ	20,61	24,53	739,-



MILENA - R

povrch | OGR - Bronz česaný



	Cena		
	bez DPH €	s DPH €	s DPH SK
BB-otvor pre kľúč	12,13	14,44	435,-
PZ-otvor pre vložku	12,13	14,44	435,-
sada s WC kľúčom	17,13	20,38	614,-
guľa / kľučka PZ	18,10	21,54	649,-



MILENA

povrch | OC - Chróm lesklý



	Cena		
	bez DPH €	s DPH €	s DPH SK
BB-otvor pre kľúč	17,76	21,14	637,-
PZ-otvor pre vložku	17,76	21,14	637,-
sada s WC kľúčom	25,24	30,04	905,-
guľa / kľučka PZ	23,51	27,98	843,-



MILENA - R

povrch | OC - Chróm lesklý



	Cena		
	bez DPH €	s DPH €	s DPH SK
BB-otvor pre kľúč	14,39	17,13	516,-
PZ-otvor pre vložku	14,39	17,13	516,-
sada s WC kľúčom	21,90	26,06	785,-
guľa / kľučka PZ	20,00	23,80	717,-





MILENA

povrch | OCS - Chróm brúsený



<i>Made in Italy</i>	Cena		
	bez DPH €	s DPH €	s DPH SK
BB-otvor pre kľúč	17,76	21,14	637,-
PZ-otvor pre vložku	17,76	21,14	637,-
sada s WC kľúčom	25,24	30,04	905,-
guľa / kľučka PZ	23,51	27,98	843,-



MILENA - R

povrch | OCS - Chróm brúsený



<i>Made in Italy</i>	Cena		
	bez DPH €	s DPH €	s DPH SK
BB-otvor pre kľúč	14,39	17,13	516,-
PZ-otvor pre vložku	14,39	17,13	516,-
sada s WC kľúčom	21,90	26,06	785,-
guľa / kľučka PZ	20,00	23,80	717,-



MILENA

povrch | ONS - Nikel brúsený



<i>Made in Italy</i>	Cena		
	bez DPH €	s DPH €	s DPH SK
BB-otvor pre kľúč	19,50	23,20	699,-
PZ-otvor pre vložku	19,50	23,20	699,-
sada s WC kľúčom	27,00	32,13	968,-
guľa / kľučka PZ	25,52	30,37	915,-



MILENA - R

povrch | ONS - Nikel brúsený



<i>Made in Italy</i>	Cena		
	bez DPH €	s DPH €	s DPH SK
BB-otvor pre kľúč	16,87	20,08	605,-
PZ-otvor pre vložku	16,87	20,08	605,-
sada s WC kľúčom	21,87	26,02	784,-
guľa / kľučka PZ	24,02	28,58	861,-



ALT WIEN

povrch | OLV - Mosadz leštená a lakovaná



<i>Made in Italy</i>	Cena		
	bez DPH €	s DPH €	s DPH SK
BB-otvor pre kľúč	17,49	20,81	627,-
PZ-otvor pre vložku	17,49	20,81	627,-
sada s WC kľúčom	22,51	26,79	807,-
guľa / kľučka PZ	22,51	26,79	807,-



ELEGANT

povrch | OLV - Mosadz leštená a lakovaná



<i>Made in Italy</i>	Cena		
	bez DPH €	s DPH €	s DPH SK
BB-otvor pre kľúč	15,01	17,86	538,-
PZ-otvor pre vložku	15,01	17,86	538,-
sada s WC kľúčom	20,00	23,80	717,-
guľa / kľučka PZ	20,00	23,80	717,-

Ostatné povrchy a ceny nájdete na našej webovej stránke.

Ostatné povrchy a ceny nájdete na našej webovej stránke.

séria | MOSADZ alebo ZLIATINA ZINKU



PETRA 2

povrch | OC - Chrom lesklý



	Cena		
	bez DPH €	s DPH €	s DPH SK
BB-otvor pre kľúč	16,71	19,88	599,-
PZ-otvor pre vložku	16,71	19,88	599,-
sada s WC kľúčom	22,29	26,52	799,-
guľa / kľučka PZ	22,29	26,52	799,-
kľučka na eurookno	10,40	12,38	373,-



PETRA 2 - R

povrch | OC - Chrom lesklý



	Cena		
	bez DPH €	s DPH €	s DPH SK
BB-otvor pre kľúč	19,50	23,20	699,-
PZ-otvor pre vložku	19,50	23,20	699,-
sada s WC kľúčom	25,08	29,84	899,-
guľa / kľučka PZ	25,08	29,84	899,-
kľučka na eurookno	10,40	12,38	373,-



PETRA 2

povrch | OCS - Chrom brúsený



	Cena		
	bez DPH €	s DPH €	s DPH SK
BB-otvor pre kľúč	16,71	19,88	599,-
PZ-otvor pre vložku	16,71	19,88	599,-
sada s WC kľúčom	22,29	26,52	799,-
guľa / kľučka PZ	22,29	26,52	799,-
kľučka na eurookno	10,40	12,38	373,-



PETRA 2 - R

povrch | OCS - Chrom brúsený



	Cena		
	bez DPH €	s DPH €	s DPH SK
BB-otvor pre kľúč	19,50	23,20	699,-
PZ-otvor pre vložku	19,50	23,20	699,-
sada s WC kľúčom	25,08	29,84	899,-
guľa / kľučka PZ	25,08	29,84	899,-
kľučka na eurookno	10,40	12,38	373,-



PETRA 2

povrch | ONS - Nikel brúsený



	Cena		
	bez DPH €	s DPH €	s DPH SK
BB-otvor pre kľúč	16,71	19,88	599,-
PZ-otvor pre vložku	16,71	19,88	599,-
sada s WC kľúčom	22,29	26,52	799,-
guľa / kľučka PZ	22,29	26,52	799,-
kľučka na eurookno	10,40	12,38	373,-



PETRA 2 - R

povrch | ONS - Nikel brúsený



	Cena		
	bez DPH €	s DPH €	s DPH SK
BB-otvor pre kľúč	19,50	23,20	699,-
PZ-otvor pre vložku	19,50	23,20	699,-
sada s WC kľúčom	25,08	29,84	899,-
guľa / kľučka PZ	25,08	29,84	899,-
kľučka na eurookno	10,40	12,38	373,-

ROMBO - R

povrch | OC - Chróm lesklý



	Cena		
	bez DPH €	s DPH €	s DPH SK
BB-otvor pre kľúč	23,40	27,85	839,-
PZ-otvor pre vložku	23,40	27,85	839,-
sada s WC kľúčom	30,66	36,48	1099,-
guľa / kľučka PZ	30,66	36,48	1099,-
kľučka na eurookno	13,92	16,56	499,-

ROMBO - R

povrch | OCS - Chróm brúsený



	Cena		
	bez DPH €	s DPH €	s DPH SK
BB-otvor pre kľúč	23,40	27,85	839,-
PZ-otvor pre vložku	23,40	27,85	839,-
sada s WC kľúčom	30,66	36,48	1099,-
guľa / kľučka PZ	30,66	36,48	1099,-
kľučka na eurookno	13,92	16,56	499,-

MARIANE - R

povrch | OC - Chróm lesklý



	Cena		
	bez DPH €	s DPH €	s DPH SK
BB-otvor pre kľúč	23,40	27,85	839,-
PZ-otvor pre vložku	23,40	27,85	839,-
sada s WC kľúčom	30,66	36,48	1099,-
guľa / kľučka PZ	30,66	36,48	1099,-
kľučka na eurookno	13,92	16,56	499,-

MARIANE - R

povrch | OCS - Chróm brúsený



	Cena		
	bez DPH €	s DPH €	s DPH SK
BB-otvor pre kľúč	23,40	27,85	839,-
PZ-otvor pre vložku	23,40	27,85	839,-
sada s WC kľúčom	30,66	36,48	1099,-
guľa / kľučka PZ	30,66	36,48	1099,-
kľučka na eurookno	13,92	16,56	499,-

ALISSE - R

povrch | OC - Chróm lesklý



	Cena		
	bez DPH €	s DPH €	s DPH SK
BB-otvor pre kľúč	23,40	27,85	839,-
PZ-otvor pre vložku	23,40	27,85	839,-
sada s WC kľúčom	30,66	36,48	1099,-
guľa / kľučka PZ	30,66	36,48	1099,-
kľučka na eurookno	13,92	16,56	499,-

ALISSE - R

povrch | OCS - Chróm brúsený



	Cena		
	bez DPH €	s DPH €	s DPH SK
BB-otvor pre kľúč	23,40	27,85	839,-
PZ-otvor pre vložku	23,40	27,85	839,-
sada s WC kľúčom	30,66	36,48	1099,-
guľa / kľučka PZ	30,66	36,48	1099,-
kľučka na eurookno	13,92	16,56	499,-



LAURA 2

povrch | OLV - Mosadz leštená a lakovaná



	Cena		
	bez DPH €	s DPH €	s DPH SK
BB-otvor pre kľúč	13,78	16,40	494,-
PZ-otvor pre vložku	13,78	16,40	494,-
sada s WC kľúčom	19,50	23,20	699,-
guľa / kľučka PZ	19,50	23,20	699,-
kľučka na eurookno	10,40	12,38	373,-

LAURA 2 - R

povrch | OLV - Mosadz leštená a lakovaná



	Cena		
	bez DPH €	s DPH €	s DPH SK
BB-otvor pre kľúč	16,71	19,88	599,-
PZ-otvor pre vložku	16,71	19,88	599,-
sada s WC kľúčom	22,29	26,52	799,-
guľa / kľučka PZ	22,29	26,52	799,-
kľučka na eurookno	10,40	12,38	373,-



LAURA 2

povrch | OLS - Mosadz brúsená a lakovaná



	Cena		
	bez DPH €	s DPH €	s DPH SK
BB-otvor pre kľúč	13,78	16,40	494,-
PZ-otvor pre vložku	13,78	16,40	494,-
sada s WC kľúčom	19,50	23,20	699,-
guľa / kľučka PZ	19,50	23,20	699,-
kľučka na eurookno	10,40	12,38	373,-



LAURA 2 - R

povrch | OLS - Mosadz brúsená a lakovaná



	Cena		
	bez DPH €	s DPH €	s DPH SK
BB-otvor pre kľúč	16,71	19,88	599,-
PZ-otvor pre vložku	16,71	19,88	599,-
sada s WC kľúčom	22,29	26,52	799,-
guľa / kľučka PZ	22,29	26,52	799,-
kľučka na eurookno	10,40	12,38	373,-



LAURA 2

povrch | OGS - Bronz česaný mat



	Cena		
	bez DPH €	s DPH €	s DPH SK
BB-otvor pre kľúč	13,78	16,40	494,-
PZ-otvor pre vložku	13,78	16,40	494,-
sada s WC kľúčom	19,50	23,20	699,-
guľa / kľučka PZ	19,50	23,20	699,-
kľučka na eurookno	10,40	12,38	373,-



LAURA 2 - R

povrch | OGS - Bronz česaný mat



	Cena		
	bez DPH €	s DPH €	s DPH SK
BB-otvor pre kľúč	16,71	19,88	599,-
PZ-otvor pre vložku	16,71	19,88	599,-
sada s WC kľúčom	22,29	26,52	799,-
guľa / kľučka PZ	22,29	26,52	799,-
kľučka na eurookno	10,40	12,38	373,-



LAURA 2

povrch | OC - Chrom leskly



	Cena		
	bez DPH €	s DPH €	s DPH SK
BB-otvor pre klúč	15,98	19,02	573,-
PZ-otvor pre vložku	15,98	19,02	573,-
sada s WC klúčom	22,29	26,52	799,-
guľa / kľučka PZ	22,29	26,52	799,-
kľučka na eurookno	11,38	13,54	408,-



LAURA 2

povrch | OCS - Chrom bruseny



	Cena		
	bez DPH €	s DPH €	s DPH SK
BB-otvor pre klúč	15,98	19,02	573,-
PZ-otvor pre vložku	15,98	19,02	573,-
sada s WC klúčom	22,29	26,52	799,-
guľa / kľučka PZ	22,29	26,52	799,-
kľučka na eurookno	11,38	13,54	408,-



LAURA 2

povrch | ONS - Nikel bruseny



	Cena		
	bez DPH €	s DPH €	s DPH SK
BB-otvor pre klúč	15,98	19,02	573,-
PZ-otvor pre vložku	15,98	19,02	573,-
sada s WC klúčom	22,29	26,52	799,-
guľa / kľučka PZ	22,29	26,52	799,-
kľučka na eurookno	11,38	13,54	408,-



LAURA 2 - R

povrch | OC - Chrom leskly



	Cena		
	bez DPH €	s DPH €	s DPH SK
BB-otvor pre klúč	18,50	22,01	663,-
PZ-otvor pre vložku	18,50	22,01	663,-
sada s WC klúčom	25,08	29,84	899,-
guľa / kľučka PZ	25,08	29,84	899,-
kľučka na eurookno	11,38	13,54	408,-



LAURA 2 - R

povrch | OCS - Chrom bruseny



	Cena		
	bez DPH €	s DPH €	s DPH SK
BB-otvor pre klúč	18,50	22,01	663,-
PZ-otvor pre vložku	18,50	22,01	663,-
sada s WC klúčom	25,08	29,84	899,-
guľa / kľučka PZ	25,08	29,84	899,-
kľučka na eurookno	11,38	13,54	408,-



LAURA 2 - R

povrch | ONS - Nikel bruseny



	Cena		
	bez DPH €	s DPH €	s DPH SK
BB-otvor pre klúč	18,50	22,01	663,-
PZ-otvor pre vložku	18,50	22,01	663,-
sada s WC klúčom	25,08	29,84	899,-
guľa / kľučka PZ	25,08	29,84	899,-
kľučka na eurookno	11,38	13,54	408,-





KRISTINA 2

povrch | OLV - Mosadz leštená a lakovaná



<i>Made in Italy</i>	Cena		
	bez DPH €	s DPH €	s DPH SK
BB-otvor pre kľúč	13,78	16,40	494,-
PZ-otvor pre vložku	13,78	16,40	494,-
sada s WC kľúčom	19,50	23,20	699,-
guľa / kľučka PZ	19,50	23,20	699,-
kľučka na eurookno	10,40	12,38	373,-



KRISTINA 2 - R

povrch | OLV - Mosadz leštená a lakovaná



<i>Made in Italy</i>	Cena		
	bez DPH €	s DPH €	s DPH SK
BB-otvor pre kľúč	16,71	19,88	599,-
PZ-otvor pre vložku	16,71	19,88	599,-
sada s WC kľúčom	22,29	26,52	799,-
guľa / kľučka PZ	22,29	26,52	799,-
kľučka na eurookno	10,40	12,38	373,-



KRISTINA 2

povrch | OLS - Mosadz brúsená a lakovaná



<i>Made in Italy</i>	Cena		
	bez DPH €	s DPH €	s DPH SK
BB-otvor pre kľúč	13,78	16,40	494,-
PZ-otvor pre vložku	13,78	16,40	494,-
sada s WC kľúčom	19,50	23,20	699,-
guľa / kľučka PZ	19,50	23,20	699,-
kľučka na eurookno	10,40	12,38	373,-



KRISTINA 2 - R

povrch | OLS - Mosadz brúsená a lakovaná



<i>Made in Italy</i>	Cena		
	bez DPH €	s DPH €	s DPH SK
BB-otvor pre kľúč	16,71	19,88	599,-
PZ-otvor pre vložku	16,71	19,88	599,-
sada s WC kľúčom	22,29	26,52	799,-
guľa / kľučka PZ	22,29	26,52	799,-
kľučka na eurookno	10,40	12,38	373,-



KRISTINA 2

povrch | OGS - Bronz česaný mat



<i>Made in Italy</i>	Cena		
	bez DPH €	s DPH €	s DPH SK
BB-otvor pre kľúč	13,78	16,40	494,-
PZ-otvor pre vložku	13,78	16,40	494,-
sada s WC kľúčom	19,50	23,20	699,-
guľa / kľučka PZ	19,50	23,20	699,-
kľučka na eurookno	10,40	12,38	373,-



KRISTINA 2 - R

povrch | OGS - Bronz česaný mat



<i>Made in Italy</i>	Cena		
	bez DPH €	s DPH €	s DPH SK
BB-otvor pre kľúč	16,71	19,88	599,-
PZ-otvor pre vložku	16,71	19,88	599,-
sada s WC kľúčom	22,29	26,52	799,-
guľa / kľučka PZ	22,29	26,52	799,-
kľučka na eurookno	10,40	12,38	373,-





KRISTINA 2

povrch | OC - Chrom leskly



Made in Italy	Cena		
	bez DPH €	s DPH €	s DPH SK
BB-otvor pre kluc	16,71	19,88	599,-
PZ-otvor pre vložku	16,71	19,88	599,-
sada s WC kluc	22,29	26,52	799,-
guľa / klucika PZ	22,29	26,52	799,-
klucika na eurookno	12,52	14,90	449,-

KRISTINA 2 - R

povrch | OC - Chrom leskly



Made in Italy	Cena		
	bez DPH €	s DPH €	s DPH SK
BB-otvor pre kluc	20,92	24,90	750,-
PZ-otvor pre vložku	20,92	24,90	750,-
sada s WC kluc	27,87	33,16	999,-
guľa / klucika PZ	27,87	33,16	999,-
klucika na eurookno	12,52	14,90	449,-



KRISTINA 2

povrch | OCS - Chrom bruseny



Made in Italy	Cena		
	bez DPH €	s DPH €	s DPH SK
BB-otvor pre kluc	16,71	19,88	599,-
PZ-otvor pre vložku	16,71	19,88	599,-
sada s WC kluc	22,29	26,52	799,-
guľa / klucika PZ	22,29	26,52	799,-
klucika na eurookno	12,52	14,90	449,-



KRISTINA 2 - R

povrch | OCS - Chrom bruseny



Made in Italy	Cena		
	bez DPH €	s DPH €	s DPH SK
BB-otvor pre kluc	20,92	24,90	750,-
PZ-otvor pre vložku	20,92	24,90	750,-
sada s WC kluc	27,87	33,16	999,-
guľa / klucika PZ	27,87	33,16	999,-
klucika na eurookno	12,52	14,90	449,-



KRISTINA 2

povrch | ONS - Nikel bruseny



Made in Italy	Cena		
	bez DPH €	s DPH €	s DPH SK
BB-otvor pre kluc	16,71	19,88	599,-
PZ-otvor pre vložku	16,71	19,88	599,-
sada s WC kluc	22,29	26,52	799,-
guľa / klucika PZ	22,29	26,52	799,-
klucika na eurookno	12,52	14,90	449,-



KRISTINA 2 - R

povrch | ONS - Nikel bruseny



Made in Italy	Cena		
	bez DPH €	s DPH €	s DPH SK
BB-otvor pre kluc	20,92	24,90	750,-
PZ-otvor pre vložku	20,92	24,90	750,-
sada s WC kluc	27,87	33,16	999,-
guľa / klucika PZ	27,87	33,16	999,-
klucika na eurookno	12,52	14,90	449,-



PRELUDE 2

povrch | OLV - Mosadz leštená a lakovaná



Made in Italy	Cena		
	bez DPH €	s DPH €	s DPH SK
BB-otvor pre kľúč	13,00	15,47	466,-
PZ-otvor pre vložku	13,00	15,47	466,-
sada s WC kľúčom	19,50	23,20	699,-
guľa / kľučka PZ	19,50	23,20	699,-
kľučka na eurookno	10,40	12,38	373,-



PRELUDE 2 - R

povrch | OLV - Mosadz leštená a lakovaná



Made in Italy	Cena		
	bez DPH €	s DPH €	s DPH SK
BB-otvor pre kľúč	16,54	19,68	593,-
PZ-otvor pre vložku	16,54	19,68	593,-
sada s WC kľúčom	23,21	27,62	832,-
guľa / kľučka PZ	23,21	27,62	832,-
kľučka na eurookno	10,40	12,38	373,-



PRELUDE 2

povrch | OLS - Mosadz brúsená a lakovaná



Made in Italy	Cena		
	bez DPH €	s DPH €	s DPH SK
BB-otvor pre kľúč	13,00	15,47	466,-
PZ-otvor pre vložku	13,00	15,47	466,-
sada s WC kľúčom	19,50	23,20	699,-
guľa / kľučka PZ	19,50	23,20	699,-
kľučka na eurookno	10,40	12,38	373,-



PRELUDE 2 - R

povrch | OLS - Mosadz brúsená a lakovaná



Made in Italy	Cena		
	bez DPH €	s DPH €	s DPH SK
BB-otvor pre kľúč	16,54	19,68	593,-
PZ-otvor pre vložku	16,54	19,68	593,-
sada s WC kľúčom	23,21	27,62	832,-
guľa / kľučka PZ	23,21	27,62	832,-
kľučka na eurookno	10,40	12,38	373,-



PRELUDE 2

povrch | OGS - Bronz česaný mat



Made in Italy	Cena		
	bez DPH €	s DPH €	s DPH SK
BB-otvor pre kľúč	13,00	15,47	466,-
PZ-otvor pre vložku	13,00	15,47	466,-
sada s WC kľúčom	19,50	23,20	699,-
guľa / kľučka PZ	19,50	23,20	699,-
kľučka na eurookno	10,40	12,38	373,-



PRELUDE 2 - R

povrch | OGS - Bronz česaný mat



Made in Italy	Cena		
	bez DPH €	s DPH €	s DPH SK
BB-otvor pre kľúč	16,54	19,68	593,-
PZ-otvor pre vložku	16,54	19,68	593,-
sada s WC kľúčom	23,21	27,62	832,-
guľa / kľučka PZ	23,21	27,62	832,-
kľučka na eurookno	10,40	12,38	373,-





PRELUDE 2

povrch | OC - Chrom lesklý



Made in Italy	Cena		
	bez DPH €	s DPH €	s DPH SK
BB-otvor pre kľúč	15,79	18,79	566,-
PZ-otvor pre vložku	15,79	18,79	566,-
sada s WC kľúčom	22,29	26,52	799,-
guľa / kľučka PZ	22,29	26,52	799,-
kľučka na eurookno	12,75	15,17	457,-

PRELUDE 2 - R

povrch | OC - Chrom lesklý



Made in Italy	Cena		
	bez DPH €	s DPH €	s DPH SK
BB-otvor pre kľúč	19,50	23,20	699,-
PZ-otvor pre vložku	19,50	23,20	699,-
sada s WC kľúčom	27,87	33,16	999,-
guľa / kľučka PZ	27,87	33,16	999,-
kľučka na eurookno	12,75	15,17	457,-



PRELUDE 2

povrch | OCS - Chrom brúsený



Made in Italy	Cena		
	bez DPH €	s DPH €	s DPH SK
BB-otvor pre kľúč	15,79	18,79	566,-
PZ-otvor pre vložku	15,79	18,79	566,-
sada s WC kľúčom	22,29	26,52	799,-
guľa / kľučka PZ	22,29	26,52	799,-
kľučka na eurookno	12,75	15,17	457,-



PRELUDE 2 - R

povrch | OCS - Chrom brúsený



Made in Italy	Cena		
	bez DPH €	s DPH €	s DPH SK
BB-otvor pre kľúč	19,50	23,20	699,-
PZ-otvor pre vložku	19,50	23,20	699,-
sada s WC kľúčom	27,87	33,16	999,-
guľa / kľučka PZ	27,87	33,16	999,-
kľučka na eurookno	12,75	15,17	457,-



PRELUDE 2

povrch | ONS - Nikel brúsený



Made in Italy	Cena		
	bez DPH €	s DPH €	s DPH SK
BB-otvor pre kľúč	15,79	18,79	566,-
PZ-otvor pre vložku	15,79	18,79	566,-
sada s WC kľúčom	22,29	26,52	799,-
guľa / kľučka PZ	22,29	26,52	799,-
kľučka na eurookno	12,75	15,17	457,-



PRELUDE 2 - R

povrch | ONS - Nikel brúsený



Made in Italy	Cena		
	bez DPH €	s DPH €	s DPH SK
BB-otvor pre kľúč	19,50	23,20	699,-
PZ-otvor pre vložku	19,50	23,20	699,-
sada s WC kľúčom	27,87	33,16	999,-
guľa / kľučka PZ	27,87	33,16	999,-
kľučka na eurookno	12,75	15,17	457,-



GIADA

povrch | OLV - Mosadz leštená a lakovaná



<i>Made in Italy</i>	Cena		
	bez DPH €	s DPH €	s DPH SK
BB-otvor pre kľúč	13,00	15,47	466,-
PZ-otvor pre vložku	13,00	15,47	466,-
sada s WC kľúčom	19,50	23,20	699,-
guľa / kľučka PZ	19,50	23,20	699,-
kľučka na eurookno	10,40	12,38	373,-



GIADA - R

povrch | OLV - Mosadz leštená a lakovaná



<i>Made in Italy</i>	Cena		
	bez DPH €	s DPH €	s DPH SK
BB-otvor pre kľúč	16,54	19,68	593,-
PZ-otvor pre vložku	16,54	19,68	593,-
sada s WC kľúčom	23,21	27,62	832,-
guľa / kľučka PZ	23,21	27,62	832,-
kľučka na eurookno	10,40	12,38	373,-



GIADA

povrch | OLS - Mosadz brúsená a lakovaná



<i>Made in Italy</i>	Cena		
	bez DPH €	s DPH €	s DPH SK
BB-otvor pre kľúč	13,00	15,47	466,-
PZ-otvor pre vložku	13,00	15,47	466,-
sada s WC kľúčom	19,50	23,20	699,-
guľa / kľučka PZ	19,50	23,20	699,-
kľučka na eurookno	10,40	12,38	373,-



GIADA - R

povrch | OLS - Mosadz brúsená a lakovaná



<i>Made in Italy</i>	Cena		
	bez DPH €	s DPH €	s DPH SK
BB-otvor pre kľúč	16,54	19,68	593,-
PZ-otvor pre vložku	16,54	19,68	593,-
sada s WC kľúčom	23,21	27,62	832,-
guľa / kľučka PZ	23,21	27,62	832,-
kľučka na eurookno	10,40	12,38	373,-



GIADA

povrch | OGS - Bronz česaný mat



<i>Made in Italy</i>	Cena		
	bez DPH €	s DPH €	s DPH SK
BB-otvor pre kľúč	13,00	15,47	466,-
PZ-otvor pre vložku	13,00	15,47	466,-
sada s WC kľúčom	19,50	23,20	699,-
guľa / kľučka PZ	19,50	23,20	699,-
kľučka na eurookno	10,40	12,38	373,-



GIADA - R

povrch | OGS - Bronz česaný mat



<i>Made in Italy</i>	Cena		
	bez DPH €	s DPH €	s DPH SK
BB-otvor pre kľúč	16,54	19,68	593,-
PZ-otvor pre vložku	16,54	19,68	593,-
sada s WC kľúčom	23,21	27,62	832,-
guľa / kľučka PZ	23,21	27,62	832,-
kľučka na eurookno	10,40	12,38	373,-





GIADA

povrch | OC - Chrom leskly



Made in Italy	Cena		
	bez DPH €	s DPH €	s DPH SK
BB-otvor pre kluc	15,79	18,79	566,-
PZ-otvor pre vložku	15,79	18,79	566,-
sada s WC kluc	22,29	26,52	799,-
guľa / klucika PZ	22,29	26,52	799,-
klucika na eurookno	12,75	15,17	457,-



GIADA

povrch | OCS - Chrom bruseny



Made in Italy	Cena		
	bez DPH €	s DPH €	s DPH SK
BB-otvor pre kluc	15,79	18,79	566,-
PZ-otvor pre vložku	15,79	18,79	566,-
sada s WC kluc	22,29	26,52	799,-
guľa / klucika PZ	22,29	26,52	799,-
klucika na eurookno	12,75	15,17	457,-



GIADA

povrch | ONS - Nikel bruseny



Made in Italy	Cena		
	bez DPH €	s DPH €	s DPH SK
BB-otvor pre kluc	15,79	18,79	566,-
PZ-otvor pre vložku	15,79	18,79	566,-
sada s WC kluc	22,29	26,52	799,-
guľa / klucika PZ	22,29	26,52	799,-
klucika na eurookno	12,75	15,17	457,-



GIADA - R

povrch | OC - Chrom leskly



Made in Italy	Cena		
	bez DPH €	s DPH €	s DPH SK
BB-otvor pre kluc	19,50	23,20	699,-
PZ-otvor pre vložku	19,50	23,20	699,-
sada s WC kluc	27,87	33,16	999,-
guľa / klucika PZ	27,87	33,16	999,-
klucika na eurookno	12,75	15,17	457,-



GIADA - R

povrch | OCS - Chrom bruseny



Made in Italy	Cena		
	bez DPH €	s DPH €	s DPH SK
BB-otvor pre kluc	19,50	23,20	699,-
PZ-otvor pre vložku	19,50	23,20	699,-
sada s WC kluc	27,87	33,16	999,-
guľa / klucika PZ	27,87	33,16	999,-
klucika na eurookno	12,75	15,17	457,-



GIADA - R

povrch | ONS - Nikel bruseny



Made in Italy	Cena		
	bez DPH €	s DPH €	s DPH SK
BB-otvor pre kluc	19,50	23,20	699,-
PZ-otvor pre vložku	19,50	23,20	699,-
sada s WC kluc	27,87	33,16	999,-
guľa / klucika PZ	27,87	33,16	999,-
klucika na eurookno	12,75	15,17	457,-





ORION 2

povrch | OLV - Mosadz leštená a lakovaná



<i>Made in Italy</i>	Cena		
	bez DPH €	s DPH €	s DPH SK
BB-otvor pre kľúč	14,78	17,59	530,-
PZ-otvor pre vložku	14,78	17,59	530,-
sada s WC kľúčom	20,89	24,86	749,-
guľa / kľučka PZ	20,89	24,86	749,-
kľučka na eurookno	10,40	12,38	373,-

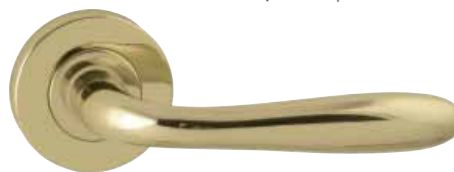

ORION 2 - R

povrch | OLV - Mosadz leštená a lakovaná



<i>Made in Italy</i>	Cena		
	bez DPH €	s DPH €	s DPH SK
BB-otvor pre kľúč	19,50	23,20	699,-
PZ-otvor pre vložku	19,50	23,20	699,-
sada s WC kľúčom	23,99	28,55	860,-
guľa / kľučka PZ	23,99	28,55	860,-
kľučka na eurookno	10,40	12,38	373,-



ORION 2

povrch | OLS - Mosadz brúsená a lakovaná



<i>Made in Italy</i>	Cena		
	bez DPH €	s DPH €	s DPH SK
BB-otvor pre kľúč	14,78	17,59	530,-
PZ-otvor pre vložku	14,78	17,59	530,-
sada s WC kľúčom	20,89	24,86	749,-
guľa / kľučka PZ	20,89	24,86	749,-
kľučka na eurookno	10,40	12,38	373,-



ORION 2 - R

povrch | OLS - Mosadz brúsená a lakovaná



<i>Made in Italy</i>	Cena		
	bez DPH €	s DPH €	s DPH SK
BB-otvor pre kľúč	19,50	23,20	699,-
PZ-otvor pre vložku	19,50	23,20	699,-
sada s WC kľúčom	23,99	28,55	860,-
guľa / kľučka PZ	23,99	28,55	860,-
kľučka na eurookno	10,40	12,38	373,-



ORION 2

povrch | OGS - Bronz česaný mat



<i>Made in Italy</i>	Cena		
	bez DPH €	s DPH €	s DPH SK
BB-otvor pre kľúč	14,78	17,59	530,-
PZ-otvor pre vložku	14,78	17,59	530,-
sada s WC kľúčom	20,89	24,86	749,-
guľa / kľučka PZ	20,89	24,86	749,-
kľučka na eurookno	10,40	12,38	373,-



ORION 2 - R

povrch | OGS - Bronz česaný mat



<i>Made in Italy</i>	Cena		
	bez DPH €	s DPH €	s DPH SK
BB-otvor pre kľúč	19,50	23,20	699,-
PZ-otvor pre vložku	19,50	23,20	699,-
sada s WC kľúčom	23,99	28,55	860,-
guľa / kľučka PZ	23,99	28,55	860,-
kľučka na eurookno	10,40	12,38	373,-





ORION 2

povrch | OC - Chróm lesklý



	Cena		
	bez DPH €	s DPH €	s DPH SK
BB-otvor pre kľúč	17,04	20,28	611,-
PZ-otvor pre vložku	17,04	20,28	611,-
sada s WC kľúčom	23,21	27,62	832,-
guľa / kľučka PZ	23,21	27,62	832,-
kľučka na eurookno	10,40	12,38	373,-



ORION 2

povrch | OCS - Chróm brúsený



	Cena		
	bez DPH €	s DPH €	s DPH SK
BB-otvor pre kľúč	17,04	20,28	611,-
PZ-otvor pre vložku	17,04	20,28	611,-
sada s WC kľúčom	23,21	27,62	832,-
guľa / kľučka PZ	23,21	27,62	832,-
kľučka na eurookno	10,40	12,38	373,-



ORION 2

povrch | ONS - Nikel brúsený



	Cena		
	bez DPH €	s DPH €	s DPH SK
BB-otvor pre kľúč	17,04	20,28	611,-
PZ-otvor pre vložku	17,04	20,28	611,-
sada s WC kľúčom	23,21	27,62	832,-
guľa / kľučka PZ	23,21	27,62	832,-
kľučka na eurookno	10,40	12,38	373,-



ORION 2 - R

povrch | OC - Chróm lesklý



	Cena		
	bez DPH €	s DPH €	s DPH SK
BB-otvor pre kľúč	19,50	23,20	699,-
PZ-otvor pre vložku	19,50	23,20	699,-
sada s WC kľúčom	26,53	31,57	951,-
guľa / kľučka PZ	26,53	31,57	951,-
kľučka na eurookno	10,40	12,38	373,-



ORION 2 - R

povrch | OCS - Chróm brúsený



	Cena		
	bez DPH €	s DPH €	s DPH SK
BB-otvor pre kľúč	19,50	23,20	699,-
PZ-otvor pre vložku	19,50	23,20	699,-
sada s WC kľúčom	26,53	31,57	951,-
guľa / kľučka PZ	26,53	31,57	951,-
kľučka na eurookno	10,40	12,38	373,-



ORION 2 - R

povrch | ONS - Nikel brúsený



	Cena		
	bez DPH €	s DPH €	s DPH SK
BB-otvor pre kľúč	19,50	23,20	699,-
PZ-otvor pre vložku	19,50	23,20	699,-
sada s WC kľúčom	26,53	31,57	951,-
guľa / kľučka PZ	26,53	31,57	951,-
kľučka na eurookno	10,40	12,38	373,-





CAST

povrch | OLV - Mosadz leštená a lakovaná



<i>Made in Italy</i>	Cena		
	bez DPH €	s DPH €	s DPH SK
BB-otvor pre kľúč	15,60	18,56	559,-
PZ-otvor pre vložku	15,60	18,56	559,-
sada s WC kľúčom	22,09	26,29	792,-
guľa / kľučka PZ	22,09	26,29	792,-
kľučka na eurookno	12,52	14,90	449,-



CAST - R

povrch | OLV - Mosadz leštená a lakovaná



<i>Made in Italy</i>	Cena		
	bez DPH €	s DPH €	s DPH SK
BB-otvor pre kľúč	19,50	23,20	699,-
PZ-otvor pre vložku	19,50	23,20	699,-
sada s WC kľúčom	25,08	29,84	899,-
guľa / kľučka PZ	25,08	29,84	899,-
kľučka na eurookno	12,52	14,90	449,-



CAST

povrch | OLS - Mosadz brúsená a lakovaná



<i>Made in Italy</i>	Cena		
	bez DPH €	s DPH €	s DPH SK
BB-otvor pre kľúč	15,60	18,56	559,-
PZ-otvor pre vložku	15,60	18,56	559,-
sada s WC kľúčom	22,09	26,29	792,-
guľa / kľučka PZ	22,09	26,29	792,-
kľučka na eurookno	12,52	14,90	449,-



CAST - R

povrch | OLS - Mosadz brúsená a lakovaná



<i>Made in Italy</i>	Cena		
	bez DPH €	s DPH €	s DPH SK
BB-otvor pre kľúč	19,50	23,20	699,-
PZ-otvor pre vložku	19,50	23,20	699,-
sada s WC kľúčom	25,08	29,84	899,-
guľa / kľučka PZ	25,08	29,84	899,-
kľučka na eurookno	12,52	14,90	449,-



CAST

povrch | OGS - Bronz česaný mat



<i>Made in Italy</i>	Cena		
	bez DPH €	s DPH €	s DPH SK
BB-otvor pre kľúč	15,60	18,56	559,-
PZ-otvor pre vložku	15,60	18,56	559,-
sada s WC kľúčom	22,09	26,29	792,-
guľa / kľučka PZ	22,09	26,29	792,-
kľučka na eurookno	12,52	14,90	449,-



CAST - R

povrch | OGS - Bronz česaný mat



<i>Made in Italy</i>	Cena		
	bez DPH €	s DPH €	s DPH SK
BB-otvor pre kľúč	19,50	23,20	699,-
PZ-otvor pre vložku	19,50	23,20	699,-
sada s WC kľúčom	25,08	29,84	899,-
guľa / kľučka PZ	25,08	29,84	899,-
kľučka na eurookno	12,52	14,90	449,-





CAST

povrch | OC - Chróm lesklý



Made in Italy	Cena		
	bez DPH €	s DPH €	s DPH SK
BB-otvor pre kľúč	18,58	22,11	666,-
PZ-otvor pre vložku	18,58	22,11	666,-
sada s WC kľúčom	25,08	29,84	899,-
guľa / kľučka PZ	25,08	29,84	899,-
kľučka na eurookno	14,76	17,56	529,-



CAST - R

povrch | OC - Chróm lesklý



Made in Italy	Cena		
	bez DPH €	s DPH €	s DPH SK
BB-otvor pre kľúč	22,26	26,49	798,-
PZ-otvor pre vložku	22,26	26,49	798,-
sada s WC kľúčom	27,87	33,16	999,-
guľa / kľučka PZ	27,87	33,16	999,-
kľučka na eurookno	14,76	17,56	529,-



CAST

povrch | OCS - Chróm brúsený



Made in Italy	Cena		
	bez DPH €	s DPH €	s DPH SK
BB-otvor pre kľúč	18,58	22,11	666,-
PZ-otvor pre vložku	18,58	22,11	666,-
sada s WC kľúčom	25,08	29,84	899,-
guľa / kľučka PZ	25,08	29,84	899,-
kľučka na eurookno	14,76	17,56	529,-



CAST - R

povrch | OCS - Chróm brúsený



Made in Italy	Cena		
	bez DPH €	s DPH €	s DPH SK
BB-otvor pre kľúč	22,26	26,49	798,-
PZ-otvor pre vložku	22,26	26,49	798,-
sada s WC kľúčom	27,87	33,16	999,-
guľa / kľučka PZ	27,87	33,16	999,-
kľučka na eurookno	14,76	17,56	529,-



CAST

povrch | ONS - Nikel brúsený



Made in Italy	Cena		
	bez DPH €	s DPH €	s DPH SK
BB-otvor pre kľúč	18,58	22,11	666,-
PZ-otvor pre vložku	18,58	22,11	666,-
sada s WC kľúčom	25,08	29,84	899,-
guľa / kľučka PZ	25,08	29,84	899,-
kľučka na eurookno	14,76	17,56	529,-



CAST - R

povrch | ONS - Nikel brúsený



Made in Italy	Cena		
	bez DPH €	s DPH €	s DPH SK
BB-otvor pre kľúč	22,26	26,49	798,-
PZ-otvor pre vložku	22,26	26,49	798,-
sada s WC kľúčom	27,87	33,16	999,-
guľa / kľučka PZ	27,87	33,16	999,-
kľučka na eurookno	14,76	17,56	529,-





ZANO

povrch | OLV - Mosadz leštená a lakovaná



<i>Made in Italy</i>	Cena		
	bez DPH €	s DPH €	s DPH SK
BB-otvor pre kľúč	15,60	18,56	559,-
PZ-otvor pre vložku	15,60	18,56	559,-
sada s WC kľúčom	22,09	26,29	792,-
guľa / kľučka PZ	22,09	26,29	792,-
kľučka na eurookno	12,52	14,90	449,-



ZANO - R

povrch | OLV - Mosadz leštená a lakovaná



<i>Made in Italy</i>	Cena		
	bez DPH €	s DPH €	s DPH SK
BB-otvor pre kľúč	19,50	23,20	699,-
PZ-otvor pre vložku	19,50	23,20	699,-
sada s WC kľúčom	25,08	29,84	899,-
guľa / kľučka PZ	25,08	29,84	899,-
kľučka na eurookno	12,52	14,90	449,-



ZANO

povrch | OLS - Mosadz brúsená a lakovaná



<i>Made in Italy</i>	Cena		
	bez DPH €	s DPH €	s DPH SK
BB-otvor pre kľúč	15,60	18,56	559,-
PZ-otvor pre vložku	15,60	18,56	559,-
sada s WC kľúčom	22,09	26,29	792,-
guľa / kľučka PZ	22,09	26,29	792,-
kľučka na eurookno	12,52	14,90	449,-



ZANO - R

povrch | OLS - Mosadz brúsená a lakovaná



<i>Made in Italy</i>	Cena		
	bez DPH €	s DPH €	s DPH SK
BB-otvor pre kľúč	19,50	23,20	699,-
PZ-otvor pre vložku	19,50	23,20	699,-
sada s WC kľúčom	25,08	29,84	899,-
guľa / kľučka PZ	25,08	29,84	899,-
kľučka na eurookno	12,52	14,90	449,-



ZANO

povrch | OGS - Bronz česaný mat



<i>Made in Italy</i>	Cena		
	bez DPH €	s DPH €	s DPH SK
BB-otvor pre kľúč	15,60	18,56	559,-
PZ-otvor pre vložku	15,60	18,56	559,-
sada s WC kľúčom	22,09	26,29	792,-
guľa / kľučka PZ	22,09	26,29	792,-
kľučka na eurookno	12,52	14,90	449,-



ZANO - R

povrch | OGS - Bronz česaný mat



<i>Made in Italy</i>	Cena		
	bez DPH €	s DPH €	s DPH SK
BB-otvor pre kľúč	19,50	23,20	699,-
PZ-otvor pre vložku	19,50	23,20	699,-
sada s WC kľúčom	25,08	29,84	899,-
guľa / kľučka PZ	25,08	29,84	899,-
kľučka na eurookno	12,52	14,90	449,-





ZANO

povrch | OC - Chrom lesklý



<i>Made in Italy</i>	Cena		
	bez DPH €	s DPH €	s DPH SK
BB-otvor pre kľúč	18,58	22,11	666,-
PZ-otvor pre vložku	18,58	22,11	666,-
sada s WC kľúčom	25,08	29,84	899,-
guľa / kľučka PZ	25,08	29,84	899,-
kľučka na eurookno	14,76	17,56	529,-

ZANO - R

povrch | OC - Chrom lesklý



<i>Made in Italy</i>	Cena		
	bez DPH €	s DPH €	s DPH SK
BB-otvor pre kľúč	22,26	26,49	798,-
PZ-otvor pre vložku	22,26	26,49	798,-
sada s WC kľúčom	27,87	33,16	999,-
guľa / kľučka PZ	27,87	33,16	999,-
kľučka na eurookno	14,76	17,56	529,-



ZANO

povrch | OCS - Chrom brúsený



<i>Made in Italy</i>	Cena		
	bez DPH €	s DPH €	s DPH SK
BB-otvor pre kľúč	18,58	22,11	666,-
PZ-otvor pre vložku	18,58	22,11	666,-
sada s WC kľúčom	25,08	29,84	899,-
guľa / kľučka PZ	25,08	29,84	899,-
kľučka na eurookno	14,76	17,56	529,-

ZANO - R

povrch | OCS - Chrom brúsený



<i>Made in Italy</i>	Cena		
	bez DPH €	s DPH €	s DPH SK
BB-otvor pre kľúč	22,26	26,49	798,-
PZ-otvor pre vložku	22,26	26,49	798,-
sada s WC kľúčom	27,87	33,16	999,-
guľa / kľučka PZ	27,87	33,16	999,-
kľučka na eurookno	14,76	17,56	529,-



ZANO

povrch | ONS - Nikel brúsený



<i>Made in Italy</i>	Cena		
	bez DPH €	s DPH €	s DPH SK
BB-otvor pre kľúč	18,58	22,11	666,-
PZ-otvor pre vložku	18,58	22,11	666,-
sada s WC kľúčom	25,08	29,84	899,-
guľa / kľučka PZ	25,08	29,84	899,-
kľučka na eurookno	14,76	17,56	529,-

ZANO - R

povrch | ONS - Nikel brúsený



<i>Made in Italy</i>	Cena		
	bez DPH €	s DPH €	s DPH SK
BB-otvor pre kľúč	22,26	26,49	798,-
PZ-otvor pre vložku	22,26	26,49	798,-
sada s WC kľúčom	27,87	33,16	999,-
guľa / kľučka PZ	27,87	33,16	999,-
kľučka na eurookno	14,76	17,56	529,-



FAN

povrch | OLV - Mosadz leštená a lakovaná



	Cena		
	bez DPH €	s DPH €	s DPH SK
<i>Italy</i> BB-otvor pre kľúč	16,26	19,35	583,-
PZ-otvor pre vložku	16,26	19,35	583,-
sada s WC kľúčom	22,29	26,52	799,-
guľa / kľučka PZ	22,29	26,52	799,-
kľučka na eurookno	12,52	14,90	449,-



FAN - R

povrch | OLV - Mosadz leštená a lakovaná



	Cena		
	bez DPH €	s DPH €	s DPH SK
<i>Italy</i> BB-otvor pre kľúč	19,50	23,20	699,-
PZ-otvor pre vložku	19,50	23,20	699,-
sada s WC kľúčom	25,08	29,84	899,-
guľa / kľučka PZ	25,08	29,84	899,-
kľučka na eurookno	12,52	14,90	449,-



FAN

povrch | OLS - Mosadz brúsená a lakovaná



	Cena		
	bez DPH €	s DPH €	s DPH SK
<i>Italy</i> BB-otvor pre kľúč	16,26	19,35	583,-
PZ-otvor pre vložku	16,26	19,35	583,-
sada s WC kľúčom	22,29	26,52	799,-
guľa / kľučka PZ	22,29	26,52	799,-
kľučka na eurookno	12,52	14,90	449,-



FAN - R

povrch | OLS - Mosadz brúsená a lakovaná



	Cena		
	bez DPH €	s DPH €	s DPH SK
<i>Italy</i> BB-otvor pre kľúč	19,50	23,20	699,-
PZ-otvor pre vložku	19,50	23,20	699,-
sada s WC kľúčom	25,08	29,84	899,-
guľa / kľučka PZ	25,08	29,84	899,-
kľučka na eurookno	12,52	14,90	449,-



FAN

povrch | OGS - Bronz česaný mat



	Cena		
	bez DPH €	s DPH €	s DPH SK
<i>Italy</i> BB-otvor pre kľúč	16,26	19,35	583,-
PZ-otvor pre vložku	16,26	19,35	583,-
sada s WC kľúčom	22,29	26,52	799,-
guľa / kľučka PZ	22,29	26,52	799,-
kľučka na eurookno	12,52	14,90	449,-



FAN - R

povrch | OGS - Bronz česaný mat



	Cena		
	bez DPH €	s DPH €	s DPH SK
<i>Italy</i> BB-otvor pre kľúč	19,50	23,20	699,-
PZ-otvor pre vložku	19,50	23,20	699,-
sada s WC kľúčom	25,08	29,84	899,-
guľa / kľučka PZ	25,08	29,84	899,-
kľučka na eurookno	12,52	14,90	449,-





FAN

povrch | OC - Chrom leskly



<i>Made in Italy</i>	Cena		
	bez DPH €	s DPH €	s DPH SK
BB-otvor pre kluc	16,57	19,72	594,-
PZ-otvor pre vložku	16,57	19,72	594,-
sada s WC kluc	25,08	29,84	899,-
guľa / klucika PZ	25,08	29,84	899,-
klucika na eurookno	12,52	14,90	449,-



FAN - R

povrch | OC - Chrom leskly



<i>Made in Italy</i>	Cena		
	bez DPH €	s DPH €	s DPH SK
BB-otvor pre kluc	19,50	23,20	699,-
PZ-otvor pre vložku	19,50	23,20	699,-
sada s WC kluc	27,25	32,43	977,-
guľa / klucika PZ	27,25	32,43	977,-
klucika na eurookno	12,52	14,90	449,-



FAN

povrch | OCS - Chrom bruseny



<i>Made in Italy</i>	Cena		
	bez DPH €	s DPH €	s DPH SK
BB-otvor pre kluc	16,57	19,72	594,-
PZ-otvor pre vložku	16,57	19,72	594,-
sada s WC kluc	25,08	29,84	899,-
guľa / klucika PZ	25,08	29,84	899,-
klucika na eurookno	12,52	14,90	449,-



FAN - R

povrch | OCS - Chrom bruseny



<i>Made in Italy</i>	Cena		
	bez DPH €	s DPH €	s DPH SK
BB-otvor pre kluc	19,50	23,20	699,-
PZ-otvor pre vložku	19,50	23,20	699,-
sada s WC kluc	27,25	32,43	977,-
guľa / klucika PZ	27,25	32,43	977,-
klucika na eurookno	12,52	14,90	449,-



FAN

povrch | ONS - Nikel bruseny



<i>Made in Italy</i>	Cena		
	bez DPH €	s DPH €	s DPH SK
BB-otvor pre kluc	16,57	19,72	594,-
PZ-otvor pre vložku	16,57	19,72	594,-
sada s WC kluc	25,08	29,84	899,-
guľa / klucika PZ	25,08	29,84	899,-
klucika na eurookno	12,52	14,90	449,-



FAN - R

povrch | ONS - Nikel bruseny



<i>Made in Italy</i>	Cena		
	bez DPH €	s DPH €	s DPH SK
BB-otvor pre kluc	19,50	23,20	699,-
PZ-otvor pre vložku	19,50	23,20	699,-
sada s WC kluc	27,25	32,43	977,-
guľa / klucika PZ	27,25	32,43	977,-
klucika na eurookno	12,52	14,90	449,-





DEA

povrch | OLV - Mosadz leštená a lakovaná



	Cena		
	bez DPH €	s DPH €	s DPH SK
<i>Italy</i> BB-otvor pre kľúč	19,50	23,20	699,-
PZ-otvor pre vložku	19,50	23,20	699,-
sada s WC kľúčom	25,08	29,84	899,-
guľa / kľučka PZ	25,08	29,84	899,-
kľučka na eurookno	14,39	17,13	516,-



DEA - R

povrch | OLV - Mosadz leštená a lakovaná



	Cena		
	bez DPH €	s DPH €	s DPH SK
<i>Italy</i> BB-otvor pre kľúč	23,99	28,55	860,-
PZ-otvor pre vložku	23,99	28,55	860,-
sada s WC kľúčom	29,85	35,52	1070,-
guľa / kľučka PZ	29,85	35,52	1070,-
kľučka na eurookno	14,39	17,13	516,-



DEA

povrch | OLS - Mosadz brúsená a lakovaná



	Cena		
	bez DPH €	s DPH €	s DPH SK
<i>Italy</i> BB-otvor pre kľúč	19,50	23,20	699,-
PZ-otvor pre vložku	19,50	23,20	699,-
sada s WC kľúčom	25,08	29,84	899,-
guľa / kľučka PZ	25,08	29,84	899,-
kľučka na eurookno	14,39	17,13	516,-



DEA - R

povrch | OLS - Mosadz brúsená a lakovaná



	Cena		
	bez DPH €	s DPH €	s DPH SK
<i>Italy</i> BB-otvor pre kľúč	23,99	28,55	860,-
PZ-otvor pre vložku	23,99	28,55	860,-
sada s WC kľúčom	29,85	35,52	1070,-
guľa / kľučka PZ	29,85	35,52	1070,-
kľučka na eurookno	14,39	17,13	516,-



DEA

povrch | OGS - Bronz česaný mat



	Cena		
	bez DPH €	s DPH €	s DPH SK
<i>Italy</i> BB-otvor pre kľúč	19,50	23,20	699,-
PZ-otvor pre vložku	19,50	23,20	699,-
sada s WC kľúčom	25,08	29,84	899,-
guľa / kľučka PZ	25,08	29,84	899,-
kľučka na eurookno	14,39	17,13	516,-



DEA - R

povrch | OGS - Bronz česaný mat



	Cena		
	bez DPH €	s DPH €	s DPH SK
<i>Italy</i> BB-otvor pre kľúč	23,99	28,55	860,-
PZ-otvor pre vložku	23,99	28,55	860,-
sada s WC kľúčom	29,85	35,52	1070,-
guľa / kľučka PZ	29,85	35,52	1070,-
kľučka na eurookno	14,39	17,13	516,-





DEA

povrch | OC - Chrom leskly



Made in Italy	Cena		
	bez DPH €	s DPH €	s DPH SK
BB-otvor pre kluc	24,38	29,01	874,-
PZ-otvor pre vložku	24,38	29,01	874,-
sada s WC kluc	31,21	37,14	1119,-
guľa / kľučka PZ	31,21	37,14	1119,-
klučka na eurookno	16,57	19,72	594,-



DEA - R

povrch | OC - Chrom leskly



Made in Italy	Cena		
	bez DPH €	s DPH €	s DPH SK
BB-otvor pre kluc	26,47	31,50	949,-
PZ-otvor pre vložku	26,47	31,50	949,-
sada s WC kluc	33,92	40,36	1216,-
guľa / kľučka PZ	33,92	40,36	1216,-
klučka na eurookno	16,57	19,72	594,-



DEA

povrch | OCS - Chrom bruseny



Made in Italy	Cena		
	bez DPH €	s DPH €	s DPH SK
BB-otvor pre kluc	24,38	29,01	874,-
PZ-otvor pre vložku	24,38	29,01	874,-
sada s WC kluc	31,21	37,14	1119,-
guľa / kľučka PZ	31,21	37,14	1119,-
klučka na eurookno	16,57	19,72	594,-



DEA - R

povrch | OCS - Chrom bruseny



Made in Italy	Cena		
	bez DPH €	s DPH €	s DPH SK
BB-otvor pre kluc	26,47	31,50	949,-
PZ-otvor pre vložku	26,47	31,50	949,-
sada s WC kluc	33,92	40,36	1216,-
guľa / kľučka PZ	33,92	40,36	1216,-
klučka na eurookno	16,57	19,72	594,-



DEA

povrch | ONS - Nikel bruseny



Made in Italy	Cena		
	bez DPH €	s DPH €	s DPH SK
BB-otvor pre kluc	24,38	29,01	874,-
PZ-otvor pre vložku	24,38	29,01	874,-
sada s WC kluc	31,21	37,14	1119,-
guľa / kľučka PZ	31,21	37,14	1119,-
klučka na eurookno	16,57	19,72	594,-



DEA - R

povrch | ONS - Nikel bruseny



Made in Italy	Cena		
	bez DPH €	s DPH €	s DPH SK
BB-otvor pre kluc	26,47	31,50	949,-
PZ-otvor pre vložku	26,47	31,50	949,-
sada s WC kluc	33,92	40,36	1216,-
guľa / kľučka PZ	33,92	40,36	1216,-
klučka na eurookno	16,57	19,72	594,-





CARINA

povrch | OLV - Mosadz leštená a lakovaná



<i>Made in Italy</i>	Cena		
	bez DPH €	s DPH €	s DPH SK
BB-otvor pre kľúč	19,50	23,20	699,-
PZ-otvor pre vložku	19,50	23,20	699,-
sada s WC kľúčom	25,08	29,84	899,-
guľa / kľučka PZ	25,08	29,84	899,-
kľučka na eurookno	14,39	17,13	516,-

CARINA - R

povrch | OLV - Mosadz leštená a lakovaná



<i>Made in Italy</i>	Cena		
	bez DPH €	s DPH €	s DPH SK
BB-otvor pre kľúč	23,99	28,55	860,-
PZ-otvor pre vložku	23,99	28,55	860,-
sada s WC kľúčom	29,85	35,52	1070,-
guľa / kľučka PZ	29,85	35,52	1070,-
kľučka na eurookno	14,39	17,13	516,-



CARINA

povrch | OGS - Bronz česaný mat



<i>Made in Italy</i>	Cena		
	bez DPH €	s DPH €	s DPH SK
BB-otvor pre kľúč	20,17	24,00	723,-
PZ-otvor pre vložku	20,17	24,00	723,-
sada s WC kľúčom	26,53	31,57	951,-
guľa / kľučka PZ	26,53	31,57	951,-
kľučka na eurookno	15,12	17,99	542,-



<i>Made in Italy</i>	Cena		
	bez DPH €	s DPH €	s DPH SK
BB-otvor pre kľúč	25,18	29,97	903,-
PZ-otvor pre vložku	25,18	29,97	903,-
sada s WC kľúčom	31,58	37,58	1132,-
guľa / kľučka PZ	31,58	37,58	1132,-
kľučka na eurookno	15,12	17,99	542,-

CARINA - R

povrch | OGS - Bronz česaný mat



MILA

povrch | OLV - Mosadz leštená a lakovaná



<i>Made in Italy</i>	Cena		
	bez DPH €	s DPH €	s DPH SK
BB-otvor pre kľúč	18,61	22,14	667,-
PZ-otvor pre vložku	18,61	22,14	667,-
sada s WC kľúčom	24,61	29,28	882,-
guľa / kľučka PZ	24,61	29,28	882,-
kľučka na eurookno	14,39	17,13	516,-



<i>Made in Italy</i>	Cena		
	bez DPH €	s DPH €	s DPH SK
BB-otvor pre kľúč	23,40	27,85	839,-
PZ-otvor pre vložku	23,40	27,85	839,-
sada s WC kľúčom	29,40	34,99	1054,-
guľa / kľučka PZ	29,40	34,99	1054,-
kľučka na eurookno	14,39	17,13	516,-

MILA - R

povrch | OLV - Mosadz leštená a lakovaná



MILLY

povrch | OLV - Mosadz leštená a lakovaná



Made in Italy	Cena		
	bez DPH €	s DPH €	s DPH SK
BB-otvor pre kľúč	19,50	23,20	699,-
PZ-otvor pre vložku	19,50	23,20	699,-
sada s WC kľúčom	25,80	30,70	925,-
guľa / kľučka PZ	25,80	30,70	925,-
kľučka na eurookno	14,90	17,73	534,-

MILLY - R

povrch | OLV - Mosadz leštená a lakovaná



Made in Italy	Cena		
	bez DPH €	s DPH €	s DPH SK
BB-otvor pre kľúč	24,61	29,28	882,-
PZ-otvor pre vložku	24,61	29,28	882,-
sada s WC kľúčom	30,60	36,41	1097,-
guľa / kľučka PZ	30,60	36,41	1097,-
kľučka na eurookno	14,90	17,73	534,-



MILLY

povrch | OGS - Bronz česaný mat



Made in Italy	Cena		
	bez DPH €	s DPH €	s DPH SK
BB-otvor pre kľúč	20,89	24,86	749,-
PZ-otvor pre vložku	20,89	24,86	749,-
sada s WC kľúčom	27,11	32,26	972,-
guľa / kľučka PZ	27,11	32,26	972,-
kľučka na eurookno	15,73	18,72	564,-

MILLY - R

povrch | OGS - Bronz česaný mat



Made in Italy	Cena		
	bez DPH €	s DPH €	s DPH SK
BB-otvor pre kľúč	25,92	30,84	929,-
PZ-otvor pre vložku	25,92	30,84	929,-
sada s WC kľúčom	32,16	38,27	1153,-
guľa / kľučka PZ	32,16	38,27	1153,-
kľučka na eurookno	15,73	18,72	564,-



MILA

povrch | OGS - Bronz česaný mat



Made in Italy	Cena		
	bez DPH €	s DPH €	s DPH SK
BB-otvor pre kľúč	18,61	22,14	667,-
PZ-otvor pre vložku	18,61	22,14	667,-
sada s WC kľúčom	24,61	29,28	882,-
guľa / kľučka PZ	24,61	29,28	882,-
kľučka na eurookno	14,39	17,13	516,-

MILA - R

povrch | OGS - Bronz česaný mat



Made in Italy	Cena		
	bez DPH €	s DPH €	s DPH SK
BB-otvor pre kľúč	23,40	27,85	839,-
PZ-otvor pre vložku	23,40	27,85	839,-
sada s WC kľúčom	29,40	34,99	1054,-
guľa / kľučka PZ	29,40	34,99	1054,-
kľučka na eurookno	14,39	17,13	516,-



LEA 1941

povrch | OGS - Bronz česaný mat (77)



	Cena		
	bez DPH €	s DPH €	s DPH SK
BB-otvor pre kľúč	36,49	43,42	1308,-
PZ-otvor pre vložku	36,49	43,42	1308,-
sada s WC kľúčom	44,77	53,28	1605,-
guľa / kľučka PZ	45,61	54,27	1635,-
kľučka na eurookno	23,13	27,52	829,-

LEA - R 1948

povrch | OGS - Bronz česaný mat (77)



	Cena		
	bez DPH €	s DPH €	s DPH SK
BB-otvor pre kľúč	36,49	43,42	1308,-
PZ-otvor pre vložku	36,49	43,42	1308,-
sada s WC kľúčom	44,77	53,28	1605,-
guľa / kľučka PZ	45,61	54,27	1635,-
kľučka na eurookno	23,13	27,52	829,-



CARLA 704

povrch | OLV - Mosadz leštená a lakovaná (01)



	Cena		
	bez DPH €	s DPH €	s DPH SK
BB-otvor pre kľúč	41,87	49,82	1501,-
PZ-otvor pre vložku	41,87	49,82	1501,-
sada s WC kľúčom	46,75	55,63	1676,-
guľa / kľučka PZ	46,75	55,63	1676,-
kľučka na eurookno	24,27	28,88	870,-



CARLA - R 738

povrch | OLV - Mosadz leštená a lakovaná (01)



	Cena		
	bez DPH €	s DPH €	s DPH SK
BB-otvor pre kľúč	37,24	44,31	1335,-
PZ-otvor pre vložku	37,24	44,31	1335,-
sada s WC kľúčom	45,58	54,24	1634,-
guľa / kľučka PZ	45,58	54,24	1634,-
kľučka na eurookno	24,27	28,88	870,-



CARLA 704

povrch | OGS - Bronz česaný mat (77)



	Cena		
	bez DPH €	s DPH €	s DPH SK
BB-otvor pre kľúč	46,08	54,84	1652,-
PZ-otvor pre vložku	46,08	54,84	1652,-
sada s WC kľúčom	51,44	61,21	1844,-
guľa / kľučka PZ	51,44	61,21	1844,-
kľučka na eurookno	27,08	32,23	971,-



CARLA - R 738

povrch | OGS - Bronz česaný mat (77)



	Cena		
	bez DPH €	s DPH €	s DPH SK
BB-otvor pre kľúč	48,12	57,26	1725,-
PZ-otvor pre vložku	48,12	57,26	1725,-
sada s WC kľúčom	57,91	68,91	2076,-
guľa / kľučka PZ	57,91	68,91	2076,-
kľučka na eurookno	27,08	32,23	971,-



SOFIA 1911

povrch | OLV - Mosadz leštená a lakovaná (01)



	Cena		
	bez DPH €	s DPH €	s DPH SK
BB-otvor pre kľúč	41,03	48,83	1471,-
PZ-otvor pre vložku	41,03	48,83	1471,-
sada s WC kľúčom	46,03	54,77	1650,-
guľa / kľučka PZ	46,03	54,77	1650,-
kľučka na eurookno	19,22	22,87	689,-

SOFIA - R 1917

povrch | OLV - Mosadz leštená a lakovaná (01)



	Cena		
	bez DPH €	s DPH €	s DPH SK
BB-otvor pre kľúč	36,21	43,09	1298,-
PZ-otvor pre vložku	36,21	43,09	1298,-
sada s WC kľúčom	44,55	53,01	1597,-
guľa / kľučka PZ	44,55	53,01	1597,-
kľučka na eurookno	19,22	22,87	689,-



SOFIA 1911

povrch | OGS - Bronz česaný mat (77)



	Cena		
	bez DPH €	s DPH €	s DPH SK
BB-otvor pre kľúč	44,18	52,58	1584,-
PZ-otvor pre vložku	44,18	52,58	1584,-
sada s WC kľúčom	49,93	59,42	1790,-
guľa / kľučka PZ	49,93	59,42	1790,-
kľučka na eurookno	23,13	27,52	829,-



	Cena		
	bez DPH €	s DPH €	s DPH SK
BB-otvor pre kľúč	39,33	46,80	1410,-
PZ-otvor pre vložku	39,33	46,80	1410,-
sada s WC kľúčom	48,92	58,22	1754,-
guľa / kľučka PZ	48,92	58,22	1754,-
kľučka na eurookno	23,13	27,52	829,-



NINA - R 1927

povrch | OGS - Matný bronz (77)



	Cena		
	bez DPH €	s DPH €	s DPH SK
BB-otvor pre kľúč	33,72	40,13	1209,-
PZ-otvor pre vložku	33,72	40,13	1209,-
sada s WC kľúčom	41,82	49,76	1499,-
guľa / kľučka PZ	41,82	49,76	1499,-
kľučka na eurookno	21,92	26,09	786,-



	Cena		
	bez DPH €	s DPH €	s DPH SK
BB-otvor pre kľúč	30,55	36,35	1095,-
PZ-otvor pre vložku	30,55	36,35	1095,-
sada s WC kľúčom	38,10	45,34	1366,-
guľa / kľučka PZ	38,10	45,34	1366,-
kľučka na eurookno	19,11	22,74	685,-

CLAUDIA - R 1938

povrch | OLV - Mosadz leštená a lakovaná (01)



	Cena		
	bez DPH €	s DPH €	s DPH SK
BB-otvor pre kľúč	36,34	43,25	1303,-
PZ-otvor pre vložku	36,34	43,25	1303,-
sada s WC kľúčom	42,15	50,16	1511,-
guľa / kľučka PZ	42,15	50,16	1511,-
kľučka na eurookno	21,73	25,86	779,-

EAGLE - R

povrch | OC - Chróm lesklý



	Cena		
	bez DPH €	s DPH €	s DPH SK
BB-otvor pre kľúč	20,76	24,70	744,-
PZ-otvor pre vložku	20,76	24,70	744,-
sada s WC kľúčom	27,87	33,16	999,-
guľa / kľučka PZ	26,25	31,24	941,-
kľučka na eurookno	18,38	21,87	659,-

CLAUDIA - R 1938

povrch | OGS - Bronz česaný mat (77)



	Cena		
	bez DPH €	s DPH €	s DPH SK
BB-otvor pre kľúč	44,82	53,34	1607,-
PZ-otvor pre vložku	44,82	53,34	1607,-
sada s WC kľúčom	53,59	63,77	1921,-
guľa / kľučka PZ	53,59	63,77	1921,-
kľučka na eurookno	26,89	32,00	964,-

EAGLE - R

povrch | OCS - Chróm brúsený



	Cena		
	bez DPH €	s DPH €	s DPH SK
BB-otvor pre kľúč	20,76	24,70	744,-
PZ-otvor pre vložku	20,76	24,70	744,-
sada s WC kľúčom	27,87	33,16	999,-
guľa / kľučka PZ	26,25	31,24	941,-
kľučka na eurookno	18,38	21,87	659,-

CLAUDIA - R 1938

povrch | ONS - Nikel brúsený (36)



	Cena		
	bez DPH €	s DPH €	s DPH SK
BB-otvor pre kľúč	40,36	48,03	1447,-
PZ-otvor pre vložku	40,36	48,03	1447,-
sada s WC kľúčom	48,23	57,39	1729,-
guľa / kľučka PZ	48,23	57,39	1729,-
kľučka na eurookno	23,55	28,02	844,-

EAGLE - R

povrch | ONS - Nikel brúsený



	Cena		
	bez DPH €	s DPH €	s DPH SK
BB-otvor pre kľúč	20,76	24,70	744,-
PZ-otvor pre vložku	20,76	24,70	744,-
sada s WC kľúčom	27,87	33,16	999,-
guľa / kľučka PZ	26,25	31,24	941,-
kľučka na eurookno	18,38	21,87	659,-

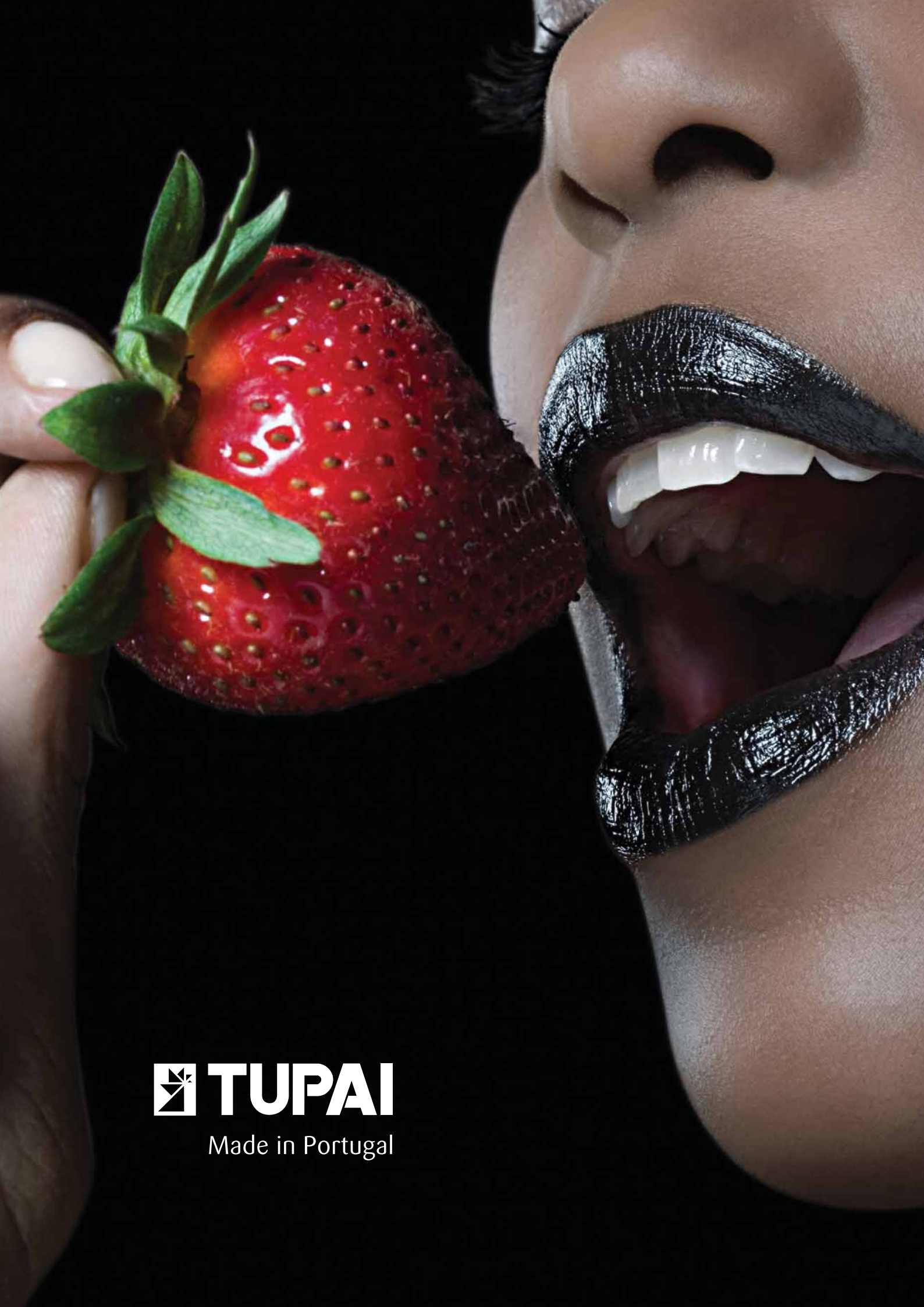

 **TUPAI**

Made in Portugal

VERONA - R 1908

povrch | OLV - Mosadz leštená a lakovaná (01)



	Cena		
	bez DPH €	s DPH €	s DPH SK
TUPAI BB-otvor pre kľúč	34,70	41,29	1244,-
PZ-otvor pre vložku	34,70	41,29	1244,-
sada s WC kľúčom	43,13	51,32	1546,-
guľa / kľučka PZ	43,13	51,32	1546,-
kľučka na eurookno	21,01	25,00	753,-



VERONA - R 1908

povrch | OGR - Bronz česaný (07)



	Cena		
	bez DPH €	s DPH €	s DPH SK
TUPAI BB-otvor pre kľúč	36,18	43,05	1297,-
PZ-otvor pre vložku	36,18	43,05	1297,-
sada s WC kľúčom	44,08	52,45	1580,-
guľa / kľučka PZ	44,08	52,45	1580,-
kľučka na eurookno	21,67	25,79	777,-



VERONA - R 1908

povrch | OGS - Bronz česaný mat (77)



	Cena		
	bez DPH €	s DPH €	s DPH SK
TUPAI BB-otvor pre kľúč	41,50	49,39	1488,-
PZ-otvor pre vložku	41,50	49,39	1488,-
sada s WC kľúčom	49,76	59,22	1784,-
guľa / kľučka PZ	49,76	59,22	1784,-
kľučka na eurookno	25,39	30,21	910,-



VERONA - R 1908

povrch | ONS - Nikel brúsený (36)

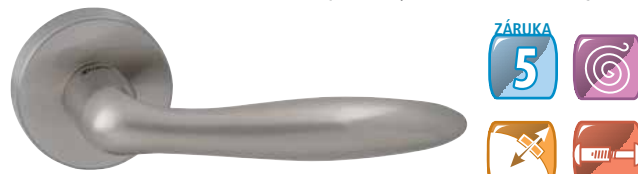

	Cena		
	bez DPH €	s DPH €	s DPH SK
TUPAI BB-otvor pre kľúč	36,49	43,42	1308,-
PZ-otvor pre vložku	36,49	43,42	1308,-
sada s WC kľúčom	44,82	53,34	1607,-
guľa / kľučka PZ	44,82	53,34	1607,-
kľučka na eurookno	21,78	25,92	781,-



TARO 1971

povrch | OCS - Chróm brúsený (96)

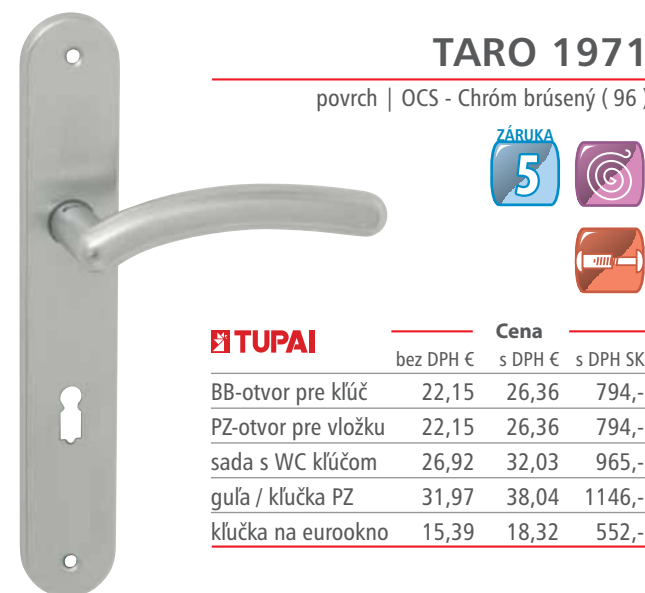

	Cena		
	bez DPH €	s DPH €	s DPH SK
TUPAI BB-otvor pre kľúč	22,15	26,36	794,-
PZ-otvor pre vložku	22,15	26,36	794,-
sada s WC kľúčom	26,92	32,03	965,-
guľa / kľučka PZ	31,97	38,04	1146,-
kľučka na eurookno	15,39	18,32	552,-



TARO - R 1977

povrch | OCS - Chróm brúsený (96)



	Cena		
	bez DPH €	s DPH €	s DPH SK
TUPAI BB-otvor pre kľúč	19,28	22,94	691,-
PZ-otvor pre vložku	19,28	22,94	691,-
sada s WC kľúčom	26,53	31,57	951,-
guľa / kľučka PZ	31,97	38,04	1146,-
kľučka na eurookno	15,39	18,32	552,-



JENNY - R 1929

povrch | OLV - Mosadz leštená a lakovaná (01)



	Cena		
	bez DPH €	s DPH €	s DPH SK
BB-otvor pre kľúč	30,55	36,35	1095,-
PZ-otvor pre vložku	30,55	36,35	1095,-
sada s WC kľúčom	38,10	45,34	1366,-
guľa / kľučka PZ	38,10	45,34	1366,-
kľučka na eurookno	19,11	22,74	685,-



JENNY - R 1929

povrch | OLS - Mosadz brúsená a lakovaná (45)

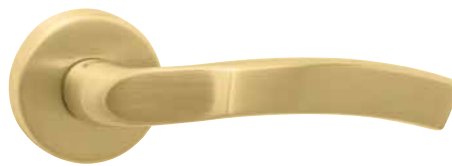

	Cena		
	bez DPH €	s DPH €	s DPH SK
BB-otvor pre kľúč	30,55	36,35	1095,-
PZ-otvor pre vložku	30,55	36,35	1095,-
sada s WC kľúčom	38,10	45,34	1366,-
guľa / kľučka PZ	38,10	45,34	1366,-
kľučka na eurookno	19,11	22,74	685,-



JENNY - R 1929

povrch | OGS - Bronz česaný mat (77)

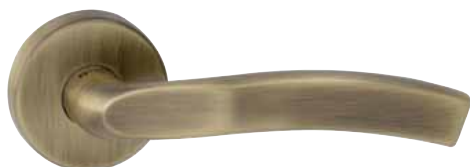

	Cena		
	bez DPH €	s DPH €	s DPH SK
BB-otvor pre kľúč	35,01	41,66	1255,-
PZ-otvor pre vložku	35,01	41,66	1255,-
sada s WC kľúčom	43,85	52,18	1572,-
guľa / kľučka PZ	43,85	52,18	1572,-
kľučka na eurookno	22,43	26,69	804,-



JENNY - R 1929

povrch | OGR - Bronz česaný (07)



	Cena		
	bez DPH €	s DPH €	s DPH SK
BB-otvor pre kľúč	30,55	36,35	1095,-
PZ-otvor pre vložku	30,55	36,35	1095,-
sada s WC kľúčom	38,10	45,34	1366,-
guľa / kľučka PZ	38,10	45,34	1366,-
kľučka na eurookno	19,11	22,74	685,-



JENNY - R 1929

povrch | OC - Chróm lesklý (03)



	Cena		
	bez DPH €	s DPH €	s DPH SK
BB-otvor pre kľúč	30,55	36,35	1095,-
PZ-otvor pre vložku	30,55	36,35	1095,-
sada s WC kľúčom	38,10	45,34	1366,-
guľa / kľučka PZ	38,10	45,34	1366,-
kľučka na eurookno	19,11	22,74	685,-



JENNY - R 1929

povrch | ONS - Nikel brúsený (36)



	Cena		
	bez DPH €	s DPH €	s DPH SK
BB-otvor pre kľúč	30,55	36,35	1095,-
PZ-otvor pre vložku	30,55	36,35	1095,-
sada s WC kľúčom	38,10	45,34	1366,-
guľa / kľučka PZ	38,10	45,34	1366,-
kľučka na eurookno	19,11	22,74	685,-



DOTS - R

povrch | OCS - Chróm brúsený



Cena

	bez DPH €	s DPH €	s DPH SK
BB-otvor pre kľúč	21,90	26,06	785,-
PZ-otvor pre vložku	21,90	26,06	785,-
sada s WC kľúčom	29,01	34,52	1040,-
guľa / kľučka PZ	28,76	34,22	1031,-
kľučka na eurookno	11,38	13,54	408,-

DOTS - HR Q

povrch | OCS - Chróm brúsený



Cena

	bez DPH €	s DPH €	s DPH SK
BB-otvor pre kľúč	27,87	33,16	999,-
PZ-otvor pre vložku	27,87	33,16	999,-
sada s WC kľúčom	34,14	40,63	1224,-
madlo / kľučka PZ	34,61	41,19	1241,-
kľučka na eurookno	11,38	13,54	408,-

DOTS - R

povrch | ONS - Nikel brúsený



Cena

	bez DPH €	s DPH €	s DPH SK
BB-otvor pre kľúč	21,90	26,06	785,-
PZ-otvor pre vložku	21,90	26,06	785,-
sada s WC kľúčom	29,01	34,52	1040,-
guľa / kľučka PZ	28,76	34,22	1031,-
kľučka na eurookno	11,38	13,54	408,-

DOTS - HR Q

povrch | ONS - Nikel brúsený



Cena

	bez DPH €	s DPH €	s DPH SK
BB-otvor pre kľúč	27,87	33,16	999,-
PZ-otvor pre vložku	27,87	33,16	999,-
sada s WC kľúčom	34,14	40,63	1224,-
madlo / kľučka PZ	34,61	41,19	1241,-
kľučka na eurookno	11,38	13,54	408,-

WIGO - R

povrch | ONS - Nikel brúsený

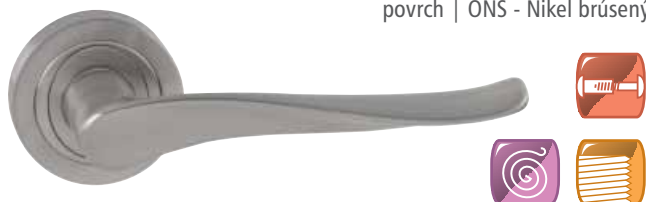

Cena

	bez DPH €	s DPH €	s DPH SK
BB-otvor pre kľúč	39,75	47,30	1425,-
PZ-otvor pre vložku	39,75	47,30	1425,-
sada s WC kľúčom	49,76	59,22	1784,-
guľa / kľučka PZ	64,77	77,08	2322,-

BONA - R 311

povrch | ONS - Nikel brúsený (36)



TUPAI

Cena

	bez DPH €	s DPH €	s DPH SK
BB-otvor pre kľúč	15,39	18,32	552,-
PZ-otvor pre vložku	15,39	18,32	552,-
sada s WC kľúčom	22,87	27,22	820,-
guľa / kľučka PZ	30,02	35,72	1076,-
kľučka na eurookno	12,35	14,70	443,-

SECO - R 1964

povrch | VOC - Velvet chróm (52)



	Cena		
	bez DPH €	s DPH €	s DPH SK
BB-otvor pre kľúč	31,55	37,54	1131,-
PZ-otvor pre vložku	31,55	37,54	1131,-
sada s WC kľúčom	38,44	45,74	1378,-
guľa / kľučka PZ	41,06	48,86	1472,-
kľučka na eurookno	19,58	23,30	702,-

SECO - HR 1964 Q

povrch | VOC - Velvet chróm (52)



	Cena		
	bez DPH €	s DPH €	s DPH SK
BB-otvor pre kľúč	33,87	40,30	1214,-
PZ-otvor pre vložku	33,87	40,30	1214,-
sada s WC kľúčom	43,02	51,19	1542,-
madlo / kľučka PZ	43,91	52,25	1574,-
kľučka na eurookno	19,58	23,30	702,-

SECO - R 1964

povrch | OC - Chróm lesklý (03)



	Cena		
	bez DPH €	s DPH €	s DPH SK
BB-otvor pre kľúč	31,55	37,54	1131,-
PZ-otvor pre vložku	31,55	37,54	1131,-
sada s WC kľúčom	38,44	45,74	1378,-
guľa / kľučka PZ	41,06	48,86	1472,-
kľučka na eurookno	19,58	23,30	702,-

SECO - HR 1964 Q

povrch | OC - Chróm lesklý (03)



	Cena		
	bez DPH €	s DPH €	s DPH SK
BB-otvor pre kľúč	33,87	40,30	1214,-
PZ-otvor pre vložku	33,87	40,30	1214,-
sada s WC kľúčom	43,02	51,19	1542,-
madlo / kľučka PZ	43,91	52,25	1574,-
kľučka na eurookno	19,58	23,30	702,-

SECO - HR 1964 Q

povrch | VONS - Velvet nikel (51)

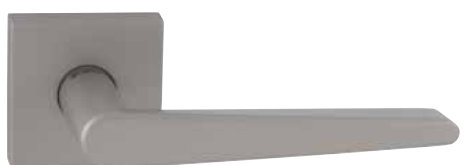

	Cena		
	bez DPH €	s DPH €	s DPH SK
BB-otvor pre kľúč	33,87	40,30	1214,-
PZ-otvor pre vložku	33,87	40,30	1214,-
sada s WC kľúčom	43,02	51,19	1542,-
madlo / kľučka PZ	43,91	52,25	1574,-
kľučka na eurookno	19,58	23,30	702,-

SECO - HR 1964 Q

povrch | OGS - Bronz česaný mat (77)



	Cena		
	bez DPH €	s DPH €	s DPH SK
BB-otvor pre kľúč	37,44	44,55	1342,-
PZ-otvor pre vložku	37,44	44,55	1342,-
sada s WC kľúčom	50,02	59,52	1793,-
madlo / kľučka PZ	53,50	63,67	1918,-
kľučka na eurookno	23,60	28,08	846,-

SQUARE - HR 2275 Q

povrch | OC - Chróm lesklý (03)



	Cena		
	bez DPH €	s DPH €	s DPH SK
BB-otvor pre kľúč	45,13	53,71	1618,-
PZ-otvor pre vložku	45,13	53,71	1618,-
sada s WC kľúčom	52,77	62,80	1892,-
madlo / kľučka PZ	54,14	64,43	1941,-
kľučka na eurookno	25,69	30,57	921,-

SQUARE - HR 2275 Q

povrch | OCS - Chróm brúsený (96)



	Cena		
	bez DPH €	s DPH €	s DPH SK
BB-otvor pre kľúč	45,13	53,71	1618,-
PZ-otvor pre vložku	45,13	53,71	1618,-
sada s WC kľúčom	52,77	62,80	1892,-
madlo / kľučka PZ	54,14	64,43	1941,-
kľučka na eurookno	25,69	30,57	921,-

SQUARE - HR 2275 Q

povrch | VONS - Velvet nikl (51)

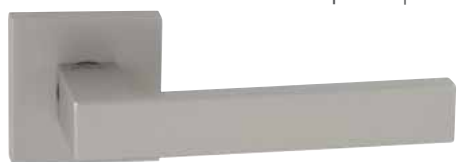

	Cena		
	bez DPH €	s DPH €	s DPH SK
BB-otvor pre kľúč	45,13	53,71	1618,-
PZ-otvor pre vložku	45,13	53,71	1618,-
sada s WC kľúčom	52,77	62,80	1892,-
madlo / kľučka PZ	54,14	64,43	1941,-
kľučka na eurookno	25,69	30,57	921,-

SQUARE - HR 2275 Q

povrch | ONS - Nikl brúsený (36)



	Cena		
	bez DPH €	s DPH €	s DPH SK
BB-otvor pre kľúč	45,13	53,71	1618,-
PZ-otvor pre vložku	45,13	53,71	1618,-
sada s WC kľúčom	52,77	62,80	1892,-
madlo / kľučka PZ	54,14	64,43	1941,-
kľučka na eurookno	25,69	30,57	921,-

SQUARE - HR 2275 Q

povrch | VOC - Velvet chróm (52)



	Cena		
	bez DPH €	s DPH €	s DPH SK
BB-otvor pre kľúč	45,13	53,71	1618,-
PZ-otvor pre vložku	45,13	53,71	1618,-
sada s WC kľúčom	52,77	62,80	1892,-
madlo / kľučka PZ	54,14	64,43	1941,-
kľučka na eurookno	25,69	30,57	921,-

SQUARE - HR 2275 Q

povrch | BVOC - Čierny velvet chróm (128)



	Cena		
	bez DPH €	s DPH €	s DPH SK
BB-otvor pre kľúč	45,13	53,71	1618,-
PZ-otvor pre vložku	45,13	53,71	1618,-
sada s WC kľúčom	52,77	62,80	1892,-
madlo / kľučka PZ	54,14	64,43	1941,-
kľučka na eurookno	25,69	30,57	921,-

BURACO 1 - HR 2737 Q

povrch | VONS - Velvet nikel (51)



	Cena		
	bez DPH €	s DPH €	s DPH SK
BB-otvor pre kľúč	49,34	58,72	1769,-
PZ-otvor pre vložku	49,34	58,72	1769,-
sada s WC kľúčom	57,24	68,11	2052,-
madlo / kľučka PZ	57,24	68,11	2052,-
kľučka na eurookno	27,65	32,90	991,-

BURACO 2 - HR 2735 Q

povrch | VONS - Velvet nikel (51)

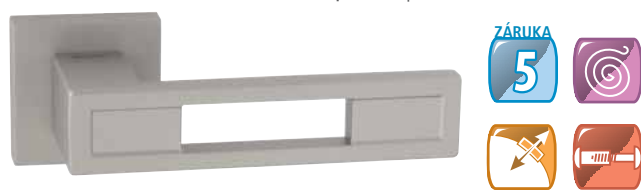

	Cena		
	bez DPH €	s DPH €	s DPH SK
BB-otvor pre kľúč	49,34	58,72	1769,-
PZ-otvor pre vložku	49,34	58,72	1769,-
sada s WC kľúčom	57,24	68,11	2052,-
madlo / kľučka PZ	57,24	68,11	2052,-
kľučka na eurookno	27,65	32,90	991,-

BURACO 1 - HR 2737 Q

povrch | OCS - Chróm brúsený (96)



	Cena		
	bez DPH €	s DPH €	s DPH SK
BB-otvor pre kľúč	49,34	58,72	1769,-
PZ-otvor pre vložku	49,34	58,72	1769,-
sada s WC kľúčom	57,24	68,11	2052,-
madlo / kľučka PZ	57,24	68,11	2052,-
kľučka na eurookno	27,65	32,90	991,-

BURACO 2 - HR 2735 Q

povrch | OCS - Chróm brúsený (96)



	Cena		
	bez DPH €	s DPH €	s DPH SK
BB-otvor pre kľúč	49,34	58,72	1769,-
PZ-otvor pre vložku	49,34	58,72	1769,-
sada s WC kľúčom	57,24	68,11	2052,-
madlo / kľučka PZ	57,24	68,11	2052,-
kľučka na eurookno	27,65	32,90	991,-

BURACO 1 - HR 2737 Q

povrch | BVOC - Čierny velvet chróm (128)



	Cena		
	bez DPH €	s DPH €	s DPH SK
BB-otvor pre kľúč	49,34	58,72	1769,-
PZ-otvor pre vložku	49,34	58,72	1769,-
sada s WC kľúčom	57,24	68,11	2052,-
madlo / kľučka PZ	57,24	68,11	2052,-
kľučka na eurookno	27,65	32,90	991,-

BURACO 2 - HR 2735 Q

povrch | BVOC - Čierny velvet chróm (128)



	Cena		
	bez DPH €	s DPH €	s DPH SK
BB-otvor pre kľúč	49,34	58,72	1769,-
PZ-otvor pre vložku	49,34	58,72	1769,-
sada s WC kľúčom	57,24	68,11	2052,-
madlo / kľučka PZ	57,24	68,11	2052,-
kľučka na eurookno	27,65	32,90	991,-

CAIRO - HR 2731 Q

povrch | OC - Chróm lesklý (03)



	Cena		
	bez DPH €	s DPH €	s DPH SK
TUPAI BB-otvor pre kľúč	41,76	49,69	1497,-
PZ-otvor pre vložku	41,76	49,69	1497,-
sada s WC kľúčom	49,26	58,62	1766,-
madlo / kľučka PZ	49,26	58,62	1766,-
kľučka na eurookno	24,21	28,81	868,-

CAIRO - HR 2731 Q

povrch | OCS - Chróm brúsený (96)



	Cena		
	bez DPH €	s DPH €	s DPH SK
TUPAI BB-otvor pre kľúč	41,76	49,69	1497,-
PZ-otvor pre vložku	41,76	49,69	1497,-
sada s WC kľúčom	49,26	58,62	1766,-
madlo / kľučka PZ	49,26	58,62	1766,-
kľučka na eurookno	24,21	28,81	868,-

CAIRO - HR 2731 Q

povrch | VONS - Velvet nikl (51)



	Cena		
	bez DPH €	s DPH €	s DPH SK
TUPAI BB-otvor pre kľúč	41,76	49,69	1497,-
PZ-otvor pre vložku	41,76	49,69	1497,-
sada s WC kľúčom	49,26	58,62	1766,-
madlo / kľučka PZ	49,26	58,62	1766,-
kľučka na eurookno	24,21	28,81	868,-

CAIRO - HR 2731 Q

povrch | OCS/OC - Chróm brúsený / chróm (115)



	Cena		
	bez DPH €	s DPH €	s DPH SK
TUPAI BB-otvor pre kľúč	41,76	49,69	1497,-
PZ-otvor pre vložku	41,76	49,69	1497,-
sada s WC kľúčom	49,26	58,62	1766,-
madlo / kľučka PZ	49,26	58,62	1766,-
kľučka na eurookno	24,21	28,81	868,-

CAIRO - HR 2731 Q

povrch | ONS - Nikel brúsený (36)



	Cena		
	bez DPH €	s DPH €	s DPH SK
TUPAI BB-otvor pre kľúč	41,76	49,69	1497,-
PZ-otvor pre vložku	41,76	49,69	1497,-
sada s WC kľúčom	49,26	58,62	1766,-
madlo / kľučka PZ	49,26	58,62	1766,-
kľučka na eurookno	24,21	28,81	868,-

CAIRO - HR 2731 Q

povrch | BVOC - Čierny velvet chróm (128)



	Cena		
	bez DPH €	s DPH €	s DPH SK
TUPAI BB-otvor pre kľúč	41,76	49,69	1497,-
PZ-otvor pre vložku	41,76	49,69	1497,-
sada s WC kľúčom	49,26	58,62	1766,-
madlo / kľučka PZ	49,26	58,62	1766,-
kľučka na eurookno	24,21	28,81	868,-

CINTO - HR 2732 Q

povrch | OC - Chróm lesklý (03)



	Cena		
	bez DPH €	s DPH €	s DPH SK
TUPAI BB-otvor pre kľúč	49,34	58,72	1769,-
PZ-otvor pre vložku	49,34	58,72	1769,-
sada s WC kľúčom	57,24	68,11	2052,-
madlo / kľučka PZ	57,24	68,11	2052,-
kľučka na eurookno	27,65	32,90	991,-

CINTO - HR 2732 Q

povrch | OCS - Chróm brúsený (96)



	Cena		
	bez DPH €	s DPH €	s DPH SK
TUPAI BB-otvor pre kľúč	49,34	58,72	1769,-
PZ-otvor pre vložku	49,34	58,72	1769,-
sada s WC kľúčom	57,24	68,11	2052,-
madlo / kľučka PZ	57,24	68,11	2052,-
kľučka na eurookno	27,65	32,90	991,-

CINTO - HR 2732 Q

povrch | VONS - Velvet nikl (51)



	Cena		
	bez DPH €	s DPH €	s DPH SK
TUPAI BB-otvor pre kľúč	49,34	58,72	1769,-
PZ-otvor pre vložku	49,34	58,72	1769,-
sada s WC kľúčom	57,24	68,11	2052,-
madlo / kľučka PZ	57,24	68,11	2052,-
kľučka na eurookno	27,65	32,90	991,-

CINTO - HR 2732 Q

povrch | OGS - Bronz česaný mat (77)



	Cena		
	bez DPH €	s DPH €	s DPH SK
TUPAI BB-otvor pre kľúč	49,34	58,72	1769,-
PZ-otvor pre vložku	49,34	58,72	1769,-
sada s WC kľúčom	57,24	68,11	2052,-
madlo / kľučka PZ	57,24	68,11	2052,-
kľučka na eurookno	27,65	32,90	991,-

CINTO - HR 2732 Q

povrch | BVOC - Čierny velvet chróm (128)



	Cena		
	bez DPH €	s DPH €	s DPH SK
TUPAI BB-otvor pre kľúč	49,34	58,72	1769,-
PZ-otvor pre vložku	49,34	58,72	1769,-
sada s WC kľúčom	57,24	68,11	2052,-
madlo / kľučka PZ	57,24	68,11	2052,-
kľučka na eurookno	27,65	32,90	991,-

CINTO - HR 2732 Q

povrch | OC / BVOC - Chróm lesklý / čierny velvet chróm



	Cena		
	bez DPH €	s DPH €	s DPH SK
TUPAI BB-otvor pre kľúč	49,34	58,72	1769,-
PZ-otvor pre vložku	49,34	58,72	1769,-
sada s WC kľúčom	57,24	68,11	2052,-
madlo / kľučka PZ	57,24	68,11	2052,-
kľučka na eurookno	27,65	32,90	991,-

LINHA 1 - HR 2736 Q

povrch | OCS - Chróm brúsený (96)



	Cena		
	bez DPH €	s DPH €	s DPH SK
TUPAI BB-otvor pre kľúč	49,34	58,72	1769,-
PZ-otvor pre vložku	49,34	58,72	1769,-
sada s WC kľúčom	57,24	68,11	2052,-
madlo / kľučka PZ	57,24	68,11	2052,-
kľučka na eurookno	27,65	32,90	991,-

LINHA 1 - HR 2736 Q

povrch | VONS - Velvet nikl (51)



	Cena		
	bez DPH €	s DPH €	s DPH SK
TUPAI BB-otvor pre kľúč	49,34	58,72	1769,-
PZ-otvor pre vložku	49,34	58,72	1769,-
sada s WC kľúčom	57,24	68,11	2052,-
madlo / kľučka PZ	57,24	68,11	2052,-
kľučka na eurookno	27,65	32,90	991,-

LINHA 1 - HR 2736 Q

povrch | OGS - Bronz česaný mat (77)



	Cena		
	bez DPH €	s DPH €	s DPH SK
TUPAI BB-otvor pre kľúč	49,34	58,72	1769,-
PZ-otvor pre vložku	49,34	58,72	1769,-
sada s WC kľúčom	57,24	68,11	2052,-
madlo / kľučka PZ	57,24	68,11	2052,-
kľučka na eurookno	27,65	32,90	991,-

LINHA 1 - HR 2736 Q

povrch | BVOC - Čierny velvet chróm (128)



	Cena		
	bez DPH €	s DPH €	s DPH SK
TUPAI BB-otvor pre kľúč	49,34	58,72	1769,-
PZ-otvor pre vložku	49,34	58,72	1769,-
sada s WC kľúčom	57,24	68,11	2052,-
madlo / kľučka PZ	57,24	68,11	2052,-
kľučka na eurookno	27,65	32,90	991,-

LINHA 1 - HR 2736 Q

povrch | OC / BVOC - Chróm lesklý / čierny velvet chróm



	Cena		
	bez DPH €	s DPH €	s DPH SK
TUPAI BB-otvor pre kľúč	49,34	58,72	1769,-
PZ-otvor pre vložku	49,34	58,72	1769,-
sada s WC kľúčom	57,24	68,11	2052,-
madlo / kľučka PZ	57,24	68,11	2052,-
kľučka na eurookno	27,65	32,90	991,-



TUPAI

LINHA 2 - HR 2730 Q

povrch | OC - Chróm lesklý (03)



	Cena		
	bez DPH €	s DPH €	s DPH SK
BB-otvor pre kľúč	49,34	58,72	1769,-
PZ-otvor pre vložku	49,34	58,72	1769,-
sada s WC kľúčom	57,24	68,11	2052,-
madlo / kľučka PZ	57,24	68,11	2052,-
kľučka na eurookno	27,65	32,90	991,-

LINHA 2 - HR 2730 Q

povrch | OCS - Chróm brúsený (96)



	Cena		
	bez DPH €	s DPH €	s DPH SK
BB-otvor pre kľúč	49,34	58,72	1769,-
PZ-otvor pre vložku	49,34	58,72	1769,-
sada s WC kľúčom	57,24	68,11	2052,-
madlo / kľučka PZ	57,24	68,11	2052,-
kľučka na eurookno	27,65	32,90	991,-

LINHA 2 - HR 2730 Q

povrch | VONS - Velvet nikl (51)

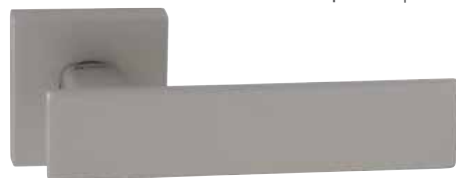

	Cena		
	bez DPH €	s DPH €	s DPH SK
BB-otvor pre kľúč	49,34	58,72	1769,-
PZ-otvor pre vložku	49,34	58,72	1769,-
sada s WC kľúčom	57,24	68,11	2052,-
madlo / kľučka PZ	57,24	68,11	2052,-
kľučka na eurookno	27,65	32,90	991,-

LINHA 2 - HR 2730 Q

povrch | OGS - Bronz česaný mat (77)



	Cena		
	bez DPH €	s DPH €	s DPH SK
BB-otvor pre kľúč	49,34	58,72	1769,-
PZ-otvor pre vložku	49,34	58,72	1769,-
sada s WC kľúčom	57,24	68,11	2052,-
madlo / kľučka PZ	57,24	68,11	2052,-
kľučka na eurookno	27,65	32,90	991,-

LINHA 2 - HR 2730 Q

povrch | BVOC - Čierny velvet chróm (128)



	Cena		
	bez DPH €	s DPH €	s DPH SK
BB-otvor pre kľúč	49,34	58,72	1769,-
PZ-otvor pre vložku	49,34	58,72	1769,-
sada s WC kľúčom	57,24	68,11	2052,-
madlo / kľučka PZ	57,24	68,11	2052,-
kľučka na eurookno	27,65	32,90	991,-

LINHA 2 - HR 2730 Q

povrch | OC / BVOC - Chróm lesklý / čierny velvet chróm



	Cena		
	bez DPH €	s DPH €	s DPH SK
BB-otvor pre kľúč	49,34	58,72	1769,-
PZ-otvor pre vložku	49,34	58,72	1769,-
sada s WC kľúčom	57,24	68,11	2052,-
madlo / kľučka PZ	57,24	68,11	2052,-
kľučka na eurookno	27,65	32,90	991,-

PRISMA - HR 1921 Q

povrch | OC - Chróm lesklý (03)



	Cena		
	bez DPH €	s DPH €	s DPH SK
TUPAI BB-otvor pre kľúč	63,04	75,02	2260,-
PZ-otvor pre vložku	63,04	75,02	2260,-
sada s WC kľúčom	71,80	85,44	2574,-
madlo / kľučka PZ	76,76	91,35	2752,-
kľučka na eurookno	33,75	40,16	1210,-

PRISMA - HR 1921 Q

povrch | OCS - Chróm brúsený (96)



	Cena		
	bez DPH €	s DPH €	s DPH SK
TUPAI BB-otvor pre kľúč	63,04	75,02	2260,-
PZ-otvor pre vložku	63,04	75,02	2260,-
sada s WC kľúčom	71,80	85,44	2574,-
madlo / kľučka PZ	76,76	91,35	2752,-
kľučka na eurookno	33,75	40,16	1210,-

PRISMA - HR 1921 Q

povrch | VONS - Velvet nikel (51)

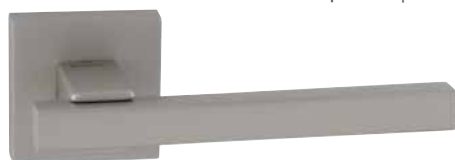

	Cena		
	bez DPH €	s DPH €	s DPH SK
TUPAI BB-otvor pre kľúč	65,03	77,38	2331,-
PZ-otvor pre vložku	65,03	77,38	2331,-
sada s WC kľúčom	73,25	87,17	2626,-
madlo / kľučka PZ	73,25	87,17	2626,-
kľučka na eurookno	34,67	41,26	1243,-

PRISMA - HR 1921 Q

povrch | OCS/OC - Chróm brúsený / chróm lesklý (115)



	Cena		
	bez DPH €	s DPH €	s DPH SK
TUPAI BB-otvor pre kľúč	63,04	75,02	2260,-
PZ-otvor pre vložku	63,04	75,02	2260,-
sada s WC kľúčom	71,80	85,44	2574,-
madlo / kľučka PZ	76,76	91,35	2752,-
kľučka na eurookno	33,75	40,16	1210,-

PRISMA - HR 1921 Q

povrch | OC/ONS - Chróm lesklý / nikel matný (112)



	Cena		
	bez DPH €	s DPH €	s DPH SK
TUPAI BB-otvor pre kľúč	63,04	75,02	2260,-
PZ-otvor pre vložku	63,04	75,02	2260,-
sada s WC kľúčom	71,80	85,44	2574,-
madlo / kľučka PZ	76,76	91,35	2752,-
kľučka na eurookno	33,75	40,16	1210,-

PRISMA - HR 1921 Q

povrch | ONS - Nikel brúsený (36)



	Cena		
	bez DPH €	s DPH €	s DPH SK
TUPAI BB-otvor pre kľúč	63,04	75,02	2260,-
PZ-otvor pre vložku	63,04	75,02	2260,-
sada s WC kľúčom	71,80	85,44	2574,-
madlo / kľučka PZ	76,76	91,35	2752,-
kľučka na eurookno	33,75	40,16	1210,-

PRISMA - HR 1921 Q

povrch | ONS/OC - Nikel brúsený / chróm leklý (117)

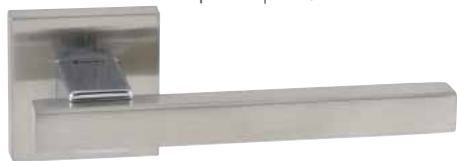

TUPAI

	Cena		
	bez DPH €	s DPH €	s DPH SK
BB-otvor pre kľúč	63,04	75,02	2260,-
PZ-otvor pre vložku	63,04	75,02	2260,-
sada s WC kľúčom	71,80	85,44	2574,-
madlo / kľučka PZ	76,76	91,35	2752,-
kľučka na eurookno	33,75	40,16	1210,-

NÁHRADNÝ DIEL DREVO



TUPAI

	Cena		
	bez DPH €	s DPH €	s DPH SK
čerešňa (13) - 1ks	7,28	8,66	261,-
wenge (15) - 1ks	7,28	8,66	261,-

CHERRY PRISMA - HR 1925 Q

povrch | ONS / CH - Nikel brúsený/ čerešňa (110/13)



TUPAI

	Cena		
	bez DPH €	s DPH €	s DPH SK
BB-otvor pre kľúč	51,02	60,71	1829,-
PZ-otvor pre vložku	51,02	60,71	1829,-
sada s WC kľúčom	58,52	69,64	2098,-
madlo / kľučka PZ	58,52	69,64	2098,-
kľučka na eurookno	30,66	36,48	1099,-

CHERRY PRISMA - HR 1925 Q

povrch | OCS / CH - Chróm brúsený/ čerešňa (96/13)



TUPAI

	Cena		
	bez DPH €	s DPH €	s DPH SK
BB-otvor pre kľúč	51,02	60,71	1829,-
PZ-otvor pre vložku	51,02	60,71	1829,-
sada s WC kľúčom	58,52	69,64	2098,-
madlo / kľučka PZ	58,52	69,64	2098,-
kľučka na eurookno	30,66	36,48	1099,-

WENGE PRISMA - HR 1925 Q

povrch | ONS / W - Nikel brúsený/ wenge (110/15)



TUPAI

	Cena		
	bez DPH €	s DPH €	s DPH SK
BB-otvor pre kľúč	51,02	60,71	1829,-
PZ-otvor pre vložku	51,02	60,71	1829,-
sada s WC kľúčom	58,52	69,64	2098,-
madlo / kľučka PZ	58,52	69,64	2098,-
kľučka na eurookno	30,66	36,48	1099,-

WENGE PRISMA - HR 1925 Q

povrch | OCS / W - Chróm brúsený/ wenge (96/15)



TUPAI

	Cena		
	bez DPH €	s DPH €	s DPH SK
BB-otvor pre kľúč	51,02	60,71	1829,-
PZ-otvor pre vložku	51,02	60,71	1829,-
sada s WC kľúčom	58,52	69,64	2098,-
madlo / kľučka PZ	58,52	69,64	2098,-
kľučka na eurookno	30,66	36,48	1099,-



ARTE

povrch | OC - Chrom lesklý



mariani	Cena		
	bez DPH €	s DPH €	s DPH SK
BB-otvor pre kľúč	59,69	71,03	2140,-
PZ-otvor pre vložku	59,69	71,03	2140,-
sada s WC kľúčom	71,13	84,64	2550,-
madlo / kľučka PZ	81,73	97,26	2930,-
kľučka na eurookno	38,50	45,81	1380,-



ARTE - HR

povrch | OC - Chrom lesklý



mariani	Cena		
	bez DPH €	s DPH €	s DPH SK
BB-otvor pre kľúč	74,48	88,63	2670,-
PZ-otvor pre vložku	74,48	88,63	2670,-
sada s WC kľúčom	85,92	102,24	3080,-
madlo / kľučka PZ	83,55	99,42	2995,-
kľučka na eurookno	38,50	45,81	1380,-



ARTE

povrch | OCS - Chrom brúsený



mariani	Cena		
	bez DPH €	s DPH €	s DPH SK
BB-otvor pre kľúč	59,69	71,03	2140,-
PZ-otvor pre vložku	59,69	71,03	2140,-
sada s WC kľúčom	71,13	84,64	2550,-
madlo / kľučka PZ	81,73	97,26	2930,-
kľučka na eurookno	38,50	45,81	1380,-



ARTE - HR

povrch | OCS - Chrom brúsený



mariani	Cena		
	bez DPH €	s DPH €	s DPH SK
BB-otvor pre kľúč	74,48	88,63	2670,-
PZ-otvor pre vložku	74,48	88,63	2670,-
sada s WC kľúčom	85,92	102,24	3080,-
madlo / kľučka PZ	83,55	99,42	2995,-
kľučka na eurookno	38,50	45,81	1380,-



ARTE

povrch | ONS - Nikel brúsený



mariani	Cena		
	bez DPH €	s DPH €	s DPH SK
BB-otvor pre kľúč	61,08	72,69	2190,-
PZ-otvor pre vložku	61,08	72,69	2190,-
sada s WC kľúčom	73,36	87,30	2630,-
madlo / kľučka PZ	83,55	99,42	2995,-
kľučka na eurookno	39,89	47,47	1430,-



ARTE - HR

povrch | ONS - Nikel brúsený



mariani	Cena		
	bez DPH €	s DPH €	s DPH SK
BB-otvor pre kľúč	76,43	90,95	2740,-
PZ-otvor pre vložku	76,43	90,95	2740,-
sada s WC kľúčom	87,87	104,56	3150,-
madlo / kľučka PZ	86,19	102,57	3090,-
kľučka na eurookno	39,89	47,47	1430,-



ARTE

povrch | OGS - Bronz česaný mat



mariani	Cena		
	bez DPH €	s DPH €	s DPH SK
BB-otvor pre kľúč	56,91	67,72	2040,-
PZ-otvor pre vložku	56,91	67,72	2040,-
sada s WC kľúčom	67,78	80,66	2430,-
madlo / kľučka PZ	77,82	92,61	2790,-
kľučka na eurookno	36,82	43,82	1320,-

ARTE - HR

povrch | OGS - Bronz česaný mat



mariani	Cena		
	bez DPH €	s DPH €	s DPH SK
BB-otvor pre kľúč	71,13	84,64	2550,-
PZ-otvor pre vložku	71,13	84,64	2550,-
sada s WC kľúčom	82,01	97,59	2940,-
madlo / kľučka PZ	80,34	95,60	2880,-
kľučka na eurookno	36,82	43,82	1320,-



ARTE

povrch | PVD ZLATÁ



mariani	Cena		
	bez DPH €	s DPH €	s DPH SK
BB-otvor pre kľúč	88,42	105,22	3170,-
PZ-otvor pre vložku	88,42	105,22	3170,-
sada s WC kľúčom	105,44	125,47	3780,-
madlo / kľučka PZ	121,06	144,06	4340,-
kľučka na eurookno	54,67	65,06	1960,-



ARTE - HR

povrch | PVD ZLATÁ



mariani	Cena		
	bez DPH €	s DPH €	s DPH SK
BB-otvor pre kľúč	108,79	129,46	3900,-
PZ-otvor pre vložku	108,79	129,46	3900,-
sada s WC kľúčom	127,19	151,36	4560,-
madlo / kľučka PZ	122,45	145,72	4390,-
kľučka na eurookno	54,67	65,06	1960,-



ARTE

povrch | PVD INOX



mariani	Cena		
	bez DPH €	s DPH €	s DPH SK
BB-otvor pre kľúč	88,42	105,22	3170,-
PZ-otvor pre vložku	88,42	105,22	3170,-
sada s WC kľúčom	105,44	125,47	3780,-
madlo / kľučka PZ	121,06	144,06	4340,-
kľučka na eurookno	54,67	65,06	1960,-



ARTE - HR

povrch | PVD INOX



mariani	Cena		
	bez DPH €	s DPH €	s DPH SK
BB-otvor pre kľúč	108,79	129,46	3900,-
PZ-otvor pre vložku	108,79	129,46	3900,-
sada s WC kľúčom	127,19	151,36	4560,-
madlo / kľučka PZ	122,45	145,72	4390,-
kľučka na eurookno	54,67	65,06	1960,-



ZENITH

povrch | OC - Chrom lesklý



mariani	Cena		
	bez DPH €	s DPH €	s DPH SK
BB-otvor pre kľúč	46,87	55,77	1680,-
PZ-otvor pre vložku	46,87	55,77	1680,-
sada s WC kľúčom	58,30	69,38	2090,-
madlo / kľučka PZ	75,03	89,29	2690,-
kľučka na eurookno	32,08	38,17	1150,-



ZENITH - HR

povrch | OC - Chrom lesklý



mariani	Cena		
	bez DPH €	s DPH €	s DPH SK
BB-otvor pre kľúč	61,37	73,03	2200,-
PZ-otvor pre vložku	61,37	73,03	2200,-
sada s WC kľúčom	73,64	87,63	2640,-
madlo / kľučka PZ	77,82	92,61	2790,-
kľučka na eurookno	32,08	38,17	1150,-



ZENITH

povrch | OCS - Chrom brúsený



mariani	Cena		
	bez DPH €	s DPH €	s DPH SK
BB-otvor pre kľúč	46,87	55,77	1680,-
PZ-otvor pre vložku	46,87	55,77	1680,-
sada s WC kľúčom	58,30	69,38	2090,-
madlo / kľučka PZ	75,03	89,29	2690,-
kľučka na eurookno	32,08	38,17	1150,-



ZENITH - HR

povrch | OCS - Chrom brúsený



mariani	Cena		
	bez DPH €	s DPH €	s DPH SK
BB-otvor pre kľúč	61,37	73,03	2200,-
PZ-otvor pre vložku	61,37	73,03	2200,-
sada s WC kľúčom	73,64	87,63	2640,-
madlo / kľučka PZ	77,82	92,61	2790,-
kľučka na eurookno	32,08	38,17	1150,-



ZENITH

povrch | ONS - Nikel brúsený



mariani	Cena		
	bez DPH €	s DPH €	s DPH SK
BB-otvor pre kľúč	47,14	56,10	1690,-
PZ-otvor pre vložku	47,14	56,10	1690,-
sada s WC kľúčom	59,97	71,37	2150,-
madlo / kľučka PZ	77,55	92,28	2780,-
kľučka na eurookno	32,92	39,17	1180,-



ZENITH - HR

povrch | ONS - Nikel brúsený



mariani	Cena		
	bez DPH €	s DPH €	s DPH SK
BB-otvor pre kľúč	63,87	76,01	2290,-
PZ-otvor pre vložku	63,87	76,01	2290,-
sada s WC kľúčom	75,03	89,29	2690,-
madlo / kľučka PZ	80,34	95,60	2880,-
kľučka na eurookno	32,92	39,17	1180,-

OVER - HR

povrch | OC - Chróm lesklý



mariani

	Cena		
	bez DPH €	s DPH €	s DPH SK
BB-otvor pre kľúč	97,35	115,85	3490,-
PZ-otvor pre vložku	97,35	115,85	3490,-
sada s WC kľúčom	108,79	129,46	3900,-
madlo / kľučka PZ	95,96	114,19	3440,-
kľučka na eurookno	49,93	59,42	1790,-

CLOUD - HR

povrch | OC - Chróm lesklý



mariani

	Cena		
	bez DPH €	s DPH €	s DPH SK
BB-otvor pre kľúč	65,27	77,67	2340,-
PZ-otvor pre vložku	65,27	77,67	2340,-
sada s WC kľúčom	76,71	91,28	2750,-
madlo / kľučka PZ	79,77	94,93	2860,-
kľučka na eurookno	34,73	41,33	1245,-

OVER - HR

povrch | OCS - Chróm brúsený



mariani

	Cena		
	bez DPH €	s DPH €	s DPH SK
BB-otvor pre kľúč	97,35	115,85	3490,-
PZ-otvor pre vložku	97,35	115,85	3490,-
sada s WC kľúčom	108,79	129,46	3900,-
madlo / kľučka PZ	95,96	114,19	3440,-
kľučka na eurookno	49,93	59,42	1790,-

CLOUD - HR

povrch | OCS - Chróm brúsený



mariani

	Cena		
	bez DPH €	s DPH €	s DPH SK
BB-otvor pre kľúč	65,27	77,67	2340,-
PZ-otvor pre vložku	65,27	77,67	2340,-
sada s WC kľúčom	76,71	91,28	2750,-
madlo / kľučka PZ	79,77	94,93	2860,-
kľučka na eurookno	34,73	41,33	1245,-

OVER - HR

povrch | ONS - Nikel brúsený



mariani

	Cena		
	bez DPH €	s DPH €	s DPH SK
BB-otvor pre kľúč	100,14	119,17	3590,-
PZ-otvor pre vložku	100,14	119,17	3590,-
sada s WC kľúčom	111,44	132,61	3995,-
madlo / kľučka PZ	98,75	117,51	3540,-
kľučka na eurookno	51,46	61,24	1845,-

CLOUD - HR

povrch | ONS - Nikel brúsený



mariani

	Cena		
	bez DPH €	s DPH €	s DPH SK
BB-otvor pre kľúč	67,78	80,66	2430,-
PZ-otvor pre vložku	67,78	80,66	2430,-
sada s WC kľúčom	79,22	94,27	2840,-
madlo / kľučka PZ	82,29	97,92	2950,-
kľučka na eurookno	35,96	42,79	1289,-



COMET

povrch | OC - Chrom lesklý



mariani

	Cena		
	bez DPH €	s DPH €	s DPH SK
BB-otvor pre kľúč	49,93	59,42	1790,-
PZ-otvor pre vložku	49,93	59,42	1790,-
sada s WC kľúčom	61,37	73,03	2200,-
madlo / kľučka PZ	76,99	91,62	2760,-
kľučka na eurookno	33,45	39,80	1199,-



COMET - HR

povrch | OC - Chrom lesklý



mariani

	Cena		
	bez DPH €	s DPH €	s DPH SK
BB-otvor pre kľúč	65,27	77,67	2340,-
PZ-otvor pre vložku	65,27	77,67	2340,-
sada s WC kľúčom	76,71	91,28	2750,-
madlo / kľučka PZ	79,50	94,60	2850,-
kľučka na eurookno	33,45	39,80	1199,-



COMET

povrch | OCS - Chrom brúsený



mariani

	Cena		
	bez DPH €	s DPH €	s DPH SK
BB-otvor pre kľúč	49,93	59,42	1790,-
PZ-otvor pre vložku	49,93	59,42	1790,-
sada s WC kľúčom	61,37	73,03	2200,-
madlo / kľučka PZ	76,99	91,62	2760,-
kľučka na eurookno	33,45	39,80	1199,-



COMET - HR

povrch | OCS - Chrom brúsený



mariani

	Cena		
	bez DPH €	s DPH €	s DPH SK
BB-otvor pre kľúč	65,27	77,67	2340,-
PZ-otvor pre vložku	65,27	77,67	2340,-
sada s WC kľúčom	76,71	91,28	2750,-
madlo / kľučka PZ	79,50	94,60	2850,-
kľučka na eurookno	33,45	39,80	1199,-



COMET

povrch | ONS - Nikel brúsený



mariani

	Cena		
	bez DPH €	s DPH €	s DPH SK
BB-otvor pre kľúč	51,61	61,41	1850,-
PZ-otvor pre vložku	51,61	61,41	1850,-
sada s WC kľúčom	63,32	75,35	2270,-
madlo / kľučka PZ	79,22	94,27	2840,-
kľučka na eurookno	34,73	41,33	1245,-



COMET - HR

povrch | ONS - Nikel brúsený



mariani

	Cena		
	bez DPH €	s DPH €	s DPH SK
BB-otvor pre kľúč	66,95	79,67	2400,-
PZ-otvor pre vložku	66,95	79,67	2400,-
sada s WC kľúčom	78,66	93,61	2820,-
madlo / kľučka PZ	82,01	97,59	2940,-
kľučka na eurookno	34,73	41,33	1245,-

COMET - HR

povrch | OC / OCS - Chróm lesklý / Chróm brúsený



mariani

Cena

	bez DPH €	s DPH €	s DPH SK
BB-otvor pre kľúč	66,95	79,67	2400,-
PZ-otvor pre vložku	66,95	79,67	2400,-
sada s WC kľúčom	79,22	94,27	2840,-
madlo / kľučka PZ	80,61	95,93	2890,-
kľučka na eurookno	34,59	41,16	1240,-

SINUA - R

povrch | OC - Chróm lesklý



mariani

Cena

	bez DPH €	s DPH €	s DPH SK
BB-otvor pre kľúč	58,30	69,38	2090,-
PZ-otvor pre vložku	58,30	69,38	2090,-
sada s WC kľúčom	69,45	82,65	2490,-

Pri povrchovej úprave ONS a VOC je cena ako pri OC.

COMET - HR

povrch | ONL / ONS - Nikel lesklý / nikel brúsený



mariani

Cena

	bez DPH €	s DPH €	s DPH SK
BB-otvor pre kľúč	69,45	82,65	2490,-
PZ-otvor pre vložku	69,45	82,65	2490,-
sada s WC kľúčom	80,61	95,93	2890,-
madlo / kľučka PZ	83,13	98,92	2980,-
kľučka na eurookno	35,71	42,49	1280,-

SOUND - R

povrch | OC - Chróm lesklý



mariani

Cena

	bez DPH €	s DPH €	s DPH SK
BB-otvor pre kľúč	63,04	75,02	2260,-
PZ-otvor pre vložku	63,04	75,02	2260,-
sada s WC kľúčom	74,48	88,63	2670,-

Pri povrchovej úprave ONS a VOC je cena ako pri OC.

COMET - HR

povrch | OLV / OLS - Mosadz leštená / mosadz brúsená



mariani

Cena

	bez DPH €	s DPH €	s DPH SK
BB-otvor pre kľúč	64,71	77,01	2320,-
PZ-otvor pre vložku	64,71	77,01	2320,-
sada s WC kľúčom	75,03	89,29	2690,-
madlo / kľučka PZ	76,99	91,62	2760,-
kľučka na eurookno	33,19	39,50	1190,-

SCAN - R

povrch | OC - Chróm lesklý



mariani

Cena

	bez DPH €	s DPH €	s DPH SK
BB-otvor pre kľúč	63,04	75,02	2260,-
PZ-otvor pre vložku	63,04	75,02	2260,-
sada s WC kľúčom	74,48	88,63	2670,-

Pri povrchovej úprave ONS a VOC je cena ako pri OC.

SUN 1 - HR

povrch | OC - Chróm lesklý



mariani

	Cena		
	bez DPH €	s DPH €	s DPH SK
BB-otvor pre kľúč	65,27	77,67	2340,-
PZ-otvor pre vložku	65,27	77,67	2340,-
sada s WC kľúčom	76,71	91,28	2750,-
madlo / kľučka PZ	79,77	94,93	2860,-
kľučka na eurookno	34,73	41,33	1245,-

SUN 1 - HR

povrch | OGS - Bronz česaný mat



mariani

	Cena		
	bez DPH €	s DPH €	s DPH SK
BB-otvor pre kľúč	62,48	74,35	2240,-
PZ-otvor pre vložku	62,48	74,35	2240,-
sada s WC kľúčom	72,52	86,30	2600,-
madlo / kľučka PZ	75,31	89,62	2700,-
kľučka na eurookno	32,64	38,84	1170,-

SUN 1 - HR

povrch | OCS - Chróm brúsený



mariani

	Cena		
	bez DPH €	s DPH €	s DPH SK
BB-otvor pre kľúč	65,27	77,67	2340,-
PZ-otvor pre vložku	65,27	77,67	2340,-
sada s WC kľúčom	76,71	91,28	2750,-
madlo / kľučka PZ	79,77	94,93	2860,-
kľučka na eurookno	34,73	41,33	1245,-

SUN 1 - HR

povrch | OC / OCS - Chróm lesklý / chróm brúsený



mariani

	Cena		
	bez DPH €	s DPH €	s DPH SK
BB-otvor pre kľúč	66,95	79,67	2400,-
PZ-otvor pre vložku	66,95	79,67	2400,-
sada s WC kľúčom	79,22	94,27	2840,-
madlo / kľučka PZ	80,61	95,93	2890,-
kľučka na eurookno	35,98	42,82	1290,-

SUN 1 - HR

povrch | ONS - Nikel brúsený



mariani

	Cena		
	bez DPH €	s DPH €	s DPH SK
BB-otvor pre kľúč	67,50	80,33	2420,-
PZ-otvor pre vložku	67,50	80,33	2420,-
sada s WC kľúčom	79,22	94,27	2840,-
madlo / kľučka PZ	82,29	97,92	2950,-
kľučka na eurookno	35,98	42,82	1290,-

SUN 1 - HR

povrch | ONL / ONS - Nikel lesklý / nikel brúsený



mariani

	Cena		
	bez DPH €	s DPH €	s DPH SK
BB-otvor pre kľúč	69,71	82,95	2499,-
PZ-otvor pre vložku	69,71	82,95	2499,-
sada s WC kľúčom	80,89	96,26	2900,-
madlo / kľučka PZ	83,40	99,25	2990,-
kľučka na eurookno	36,96	43,98	1325,-

SUN 2 - HR

povrch | OC - Chrom lesklý



	Cena		
	bez DPH €	s DPH €	s DPH SK
BB-otvor pre kľúč	69,71	82,95	2499,-
PZ-otvor pre vložku	69,71	82,95	2499,-
sada s WC kľúčom	82,01	97,59	2940,-
madlo / kľučka PZ	82,29	97,92	2950,-
kľučka na eurookno	35,71	42,49	1280,-

SUN 3 - HR

povrch | OC - Chrom lesklý



	Cena		
	bez DPH €	s DPH €	s DPH SK
BB-otvor pre kľúč	69,71	82,95	2499,-
PZ-otvor pre vložku	69,71	82,95	2499,-
sada s WC kľúčom	82,01	97,59	2940,-
madlo / kľučka PZ	82,29	97,92	2950,-
kľučka na eurookno	35,71	42,49	1280,-

SUN 2 - HR

povrch | OCS - Chrom brúsený



	Cena		
	bez DPH €	s DPH €	s DPH SK
BB-otvor pre kľúč	69,71	82,95	2499,-
PZ-otvor pre vložku	69,71	82,95	2499,-
sada s WC kľúčom	82,01	97,59	2940,-
madlo / kľučka PZ	82,29	97,92	2950,-
kľučka na eurookno	35,71	42,49	1280,-

SUN 3 - HR

povrch | OCS - Chrom brúsený



	Cena		
	bez DPH €	s DPH €	s DPH SK
BB-otvor pre kľúč	69,71	82,95	2499,-
PZ-otvor pre vložku	69,71	82,95	2499,-
sada s WC kľúčom	82,01	97,59	2940,-
madlo / kľučka PZ	82,29	97,92	2950,-
kľučka na eurookno	35,71	42,49	1280,-

SUN 2 - HR

povrch | ONS - Nikel brúsený



	Cena		
	bez DPH €	s DPH €	s DPH SK
BB-otvor pre kľúč	70,85	84,31	2540,-
PZ-otvor pre vložku	70,85	84,31	2540,-
sada s WC kľúčom	82,29	97,92	2950,-
madlo / kľučka PZ	83,40	99,25	2990,-
kľučka na eurookno	37,38	44,48	1340,-

SUN 3 - HR

povrch | ONS - Nikel brúsený



	Cena		
	bez DPH €	s DPH €	s DPH SK
BB-otvor pre kľúč	70,85	84,31	2540,-
PZ-otvor pre vložku	70,85	84,31	2540,-
sada s WC kľúčom	82,29	97,92	2950,-
madlo / kľučka PZ	83,40	99,25	2990,-
kľučka na eurookno	37,38	44,48	1340,-



GOLF

povrch | OC - Chrom lesklý



mariani

	Cena		
	bez DPH €	s DPH €	s DPH SK
BB-otvor pre kľúč	95,96	114,19	3440,-
PZ-otvor pre vložku	95,96	114,19	3440,-
sada s WC kľúčom	107,39	127,80	3850,-
madlo / kľučka PZ	102,65	122,15	3680,-
kľučka na eurookno	43,51	51,78	1560,-

GOLF - HR

povrch | OC - Chrom lesklý



mariani

	Cena		
	bez DPH €	s DPH €	s DPH SK
BB-otvor pre kľúč	84,38	100,41	3025,-
PZ-otvor pre vložku	84,38	100,41	3025,-
sada s WC kľúčom	96,93	115,35	3475,-
madlo / kľučka PZ	86,45	102,87	3099,-
kľučka na eurookno	43,51	51,78	1560,-



GOLF

povrch | OCS - Chrom brúsený



mariani

	Cena		
	bez DPH €	s DPH €	s DPH SK
BB-otvor pre kľúč	95,96	114,19	3440,-
PZ-otvor pre vložku	95,96	114,19	3440,-
sada s WC kľúčom	107,39	127,80	3850,-
madlo / kľučka PZ	102,65	122,15	3680,-
kľučka na eurookno	43,51	51,78	1560,-

GOLF - HR

povrch | OCS - Chrom brúsený



mariani

	Cena		
	bez DPH €	s DPH €	s DPH SK
BB-otvor pre kľúč	84,38	100,41	3025,-
PZ-otvor pre vložku	84,38	100,41	3025,-
sada s WC kľúčom	96,93	115,35	3475,-
madlo / kľučka PZ	86,45	102,87	3099,-
kľučka na eurookno	43,51	51,78	1560,-



GOLF

povrch | ONS - Nikel brúsený



mariani

	Cena		
	bez DPH €	s DPH €	s DPH SK
BB-otvor pre kľúč	99,30	118,17	3560,-
PZ-otvor pre vložku	99,30	118,17	3560,-
sada s WC kľúčom	111,02	132,11	3980,-
madlo / kľučka PZ	101,25	120,49	3630,-
kľučka na eurookno	45,18	53,77	1620,-

GOLF - HR

povrch | ONS - Nikel brúsený



mariani

	Cena		
	bez DPH €	s DPH €	s DPH SK
BB-otvor pre kľúč	87,59	104,23	3140,-
PZ-otvor pre vložku	87,59	104,23	3140,-
sada s WC kľúčom	100,42	119,50	3600,-
madlo / kľučka PZ	90,10	107,22	3230,-
kľučka na eurookno	45,18	53,77	1620,-



GOLF

povrch | OGS - Bronz česaný mat



mariani

	Cena		
	bez DPH €	s DPH €	s DPH SK
BB-otvor pre kľúč	91,21	108,54	3270,-
PZ-otvor pre vložku	91,21	108,54	3270,-
sada s WC kľúčom	101,54	120,83	3640,-
madlo / kľučka PZ	92,89	110,54	3330,-
kľučka na eurookno	41,56	49,46	1490,-

GOLF - HR

povrch | OGS - Bronz česaný mat



mariani

	Cena		
	bez DPH €	s DPH €	s DPH SK
BB-otvor pre kľúč	80,34	95,60	2880,-
PZ-otvor pre vložku	80,34	95,60	2880,-
sada s WC kľúčom	92,05	109,54	3300,-
madlo / kľučka PZ	82,56	98,25	2960,-
kľučka na eurookno	41,56	49,46	1490,-



ZOE

povrch | OC - Chrom lesklý



mariani

	Cena		
	bez DPH €	s DPH €	s DPH SK
BB-otvor pre kľúč	65,27	77,67	2340,-
PZ-otvor pre vložku	65,27	77,67	2340,-
sada s WC kľúčom	76,99	91,62	2760,-
madlo / kľučka PZ	84,80	100,91	3040,-
kľučka na eurookno	30,40	36,18	1090,-



ZOE - R

povrch | OC - Chrom lesklý



mariani

	Cena		
	bez DPH €	s DPH €	s DPH SK
BB-otvor pre kľúč	77,82	92,61	2790,-
PZ-otvor pre vložku	77,82	92,61	2790,-
sada s WC kľúčom	88,98	105,89	3190,-
madlo / kľučka PZ	91,77	109,21	3290,-
kľučka na eurookno	30,40	36,18	1090,-



ZOE

povrch | OCS - Chrom brúsený



mariani

	Cena		
	bez DPH €	s DPH €	s DPH SK
BB-otvor pre kľúč	65,27	77,67	2340,-
PZ-otvor pre vložku	65,27	77,67	2340,-
sada s WC kľúčom	76,99	91,62	2760,-
madlo / kľučka PZ	84,80	100,91	3040,-
kľučka na eurookno	30,40	36,18	1090,-



ZOE - R

povrch | OCS - Chrom brúsený



mariani

	Cena		
	bez DPH €	s DPH €	s DPH SK
BB-otvor pre kľúč	77,82	92,61	2790,-
PZ-otvor pre vložku	77,82	92,61	2790,-
sada s WC kľúčom	88,98	105,89	3190,-
madlo / kľučka PZ	91,77	109,21	3290,-
kľučka na eurookno	30,40	36,18	1090,-



ZOE

povrch | ONS - Nikel brúsený



mariani

	Cena		
	bez DPH €	s DPH €	s DPH SK
BB-otvor pre kľúč	67,50	80,33	2420,-
PZ-otvor pre vložku	67,50	80,33	2420,-
sada s WC kľúčom	79,22	94,27	2840,-
madlo / kľučka PZ	87,17	103,73	3125,-
kľučka na eurookno	31,38	37,34	1125,-



ZOE - R

povrch | ONS - Nikel brúsený



mariani

	Cena		
	bez DPH €	s DPH €	s DPH SK
BB-otvor pre kľúč	80,06	95,27	2870,-
PZ-otvor pre vložku	80,06	95,27	2870,-
sada s WC kľúčom	91,86	109,31	3293,-
madlo / kľučka PZ	94,82	112,83	3399,-
kľučka na eurookno	31,38	37,34	1125,-



ZOE

povrch | OGS - Bronz česaný mat



mariani

	Cena		
	bez DPH €	s DPH €	s DPH SK
BB-otvor pre kľúč	55,51	66,06	1990,-
PZ-otvor pre vložku	55,51	66,06	1990,-
sada s WC kľúčom	66,66	79,33	2390,-
madlo / kľučka PZ	77,55	92,28	2780,-
kľučka na eurookno	27,87	33,16	999,-



ZOE - R

povrch | OGS - Bronz česaný mat



mariani

	Cena		
	bez DPH €	s DPH €	s DPH SK
BB-otvor pre kľúč	72,52	86,30	2600,-
PZ-otvor pre vložku	72,52	86,30	2600,-
sada s WC kľúčom	83,40	99,25	2990,-
madlo / kľučka PZ	87,87	104,56	3150,-
kľučka na eurookno	27,87	33,16	999,-



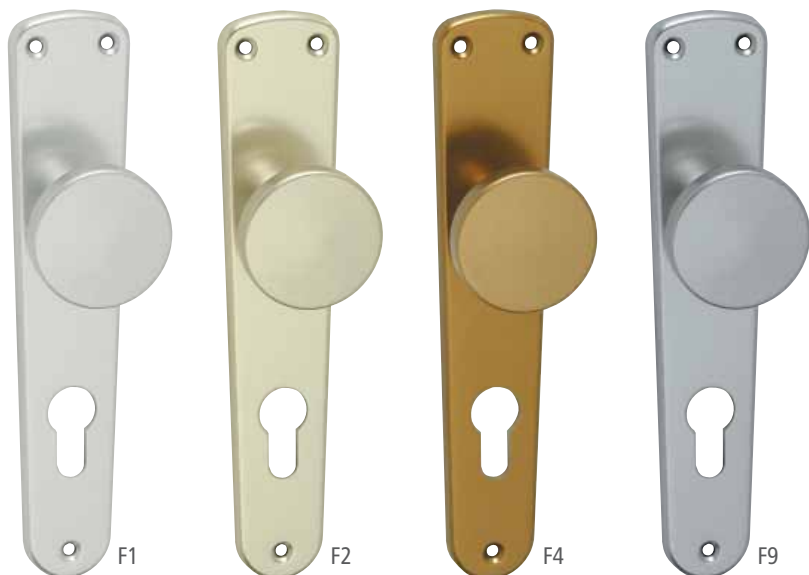

ŠTÍT S GUĽOU B/7071

Štít s guľou používaný pri modeloch LUXOR a KLASIK

Made in Italy

povrch	Cena		
	bez DPH €	s DPH €	s DPH SK
F1 - prírodný elox	6,00	7,14	215,-
F2 - šampáňo elox	6,00	7,14	215,-
F4 - bronz elox	6,00	7,14	215,-
F9 - nerez elox	6,47	7,70	232,-



ŠTÍT S GUĽOU I/7071

Štít s guľou používaný pri modeli LUCIA

Made in Italy

povrch	Cena		
	bez DPH €	s DPH €	s DPH SK
F1 - prírodný elox	6,00	7,14	215,-
F2 - šampáňo elox	6,00	7,14	215,-
F4 - bronz elox	6,00	7,14	215,-
F9 - nerez elox	6,47	7,70	232,-

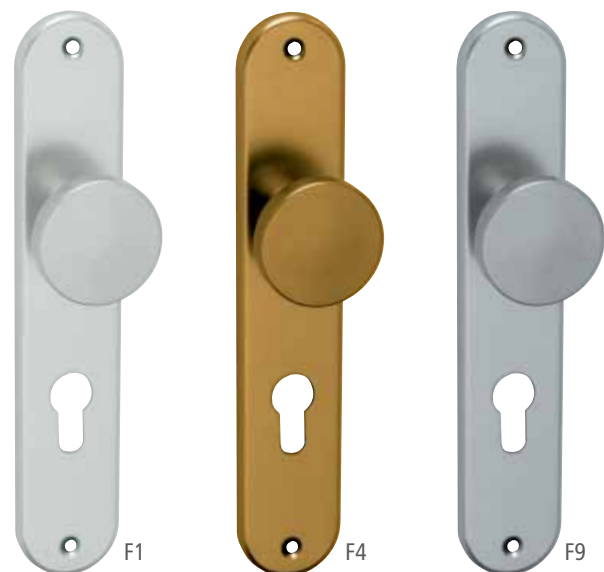

ŠTÍT S GUĽOU S/7071

Štít s guľou používaný pri modeloch VITO, ARCH, MIRA, MEDOX, REAL, SAMBA, VERONA, FAVORIT, DAFNE, SABINA, CRONO, GARDA, COSLAN, NETUNO

Made in Italy

povrch	Cena		
	bez DPH €	s DPH €	s DPH SK
F1 - prírodný elox	6,64	7,90	238,-
F4 - bronz elox	6,64	7,90	238,-
F9 - nerez elox	7,25	8,63	260,-



ŠTÍT S GULOU TB/7071

Štít s guľou používaný pri modeli
VIENNA

Made in Italy

povrch	Cena		
	bez DPH €	s DPH €	s DPH SK
F1 - prírodný elox	7,50	8,93	269,-
F4 - bronz elox	7,50	8,93	269,-
F9 - nerez elox	8,06	9,59	289,-

GUĽA PEVNÁ NA ROZETE

Používaná pri všetkých rozetových, hliníkových modeloch
v prevedení guľa / kľučka

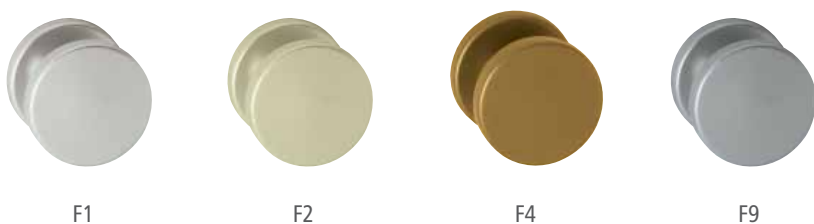

Made in Italy

povrch	Cena		
	bez DPH €	s DPH €	s DPH SK
F1, F2, F4	8,31	9,89	298,-
F9	9,43	11,22	338,-

GUĽA FIXA NA ŠTÍTE PK

Tieto guľe na štítoch (GUĽA FIXA NA ŠTÍTE PK)
sú použité ako štandard
pri modeloch uvedených na stranách 53 - 72.



Made in Italy

povrch	Cena		
	bez DPH €	s DPH €	s DPH SK
1. OC - Chróm lesklý	16,71	19,88	599,-
2. OCS - Chróm brúsený	16,71	19,88	599,-
3. ONS - Nikel brúsený	16,71	19,88	599,-
4. OGS - Bronz česaný	13,92	16,56	499,-
5. OLV - Mosadz leštená	13,92	16,56	499,-
6. OLS - Mosadz brúsená	13,92	16,56	499,-



GUĽA FIXA - 50mm

povrch | OC - Chróm lesklý



	Cena		
	bez DPH €	s DPH €	s DPH SK
<i>Made in Italy</i> guľa pevná (kus)	17,57	20,91	630,-
guľa pevná / guľa pevná pár	30,13	35,85	1080,-
guľa pevná / guľa otočná pár	30,13	35,85	1080,-
guľa otočná / guľa otočná pár	25,08	29,84	899,-

*

GUĽA FIXA - 50mm

povrch | OCS - Chróm brúsený



	Cena		
	bez DPH €	s DPH €	s DPH SK
<i>Made in Italy</i> guľa pevná (kus)	17,57	20,91	630,-
guľa pevná / guľa pevná pár	30,13	35,85	1080,-
guľa pevná / guľa otočná pár	30,13	35,85	1080,-
guľa otočná / guľa otočná pár	25,08	29,84	899,-

*

GUĽA FIXA - 50mm

povrch | ONS - Nikel brúsený



	Cena		
	bez DPH €	s DPH €	s DPH SK
<i>Made in Italy</i> guľa pevná (kus)	17,57	20,91	630,-
guľa pevná / guľa pevná pár	30,13	35,85	1080,-
guľa pevná / guľa otočná pár	30,13	35,85	1080,-
guľa otočná / guľa otočná pár	25,08	29,84	899,-

*

GUĽA FIXA - 50mm

povrch | OGS - Bronz česaný mat



	Cena		
	bez DPH €	s DPH €	s DPH SK
<i>Made in Italy</i> guľa pevná (kus)	15,06	17,92	540,-
guľa pevná / guľa pevná pár	25,08	29,84	899,-
guľa pevná / guľa otočná pár	25,08	29,84	899,-
guľa otočná / guľa otočná pár	20,92	24,89	750,-

*

GUĽA FIXA - 50mm

povrch | OLV - Mosadz leštená a lakovaná

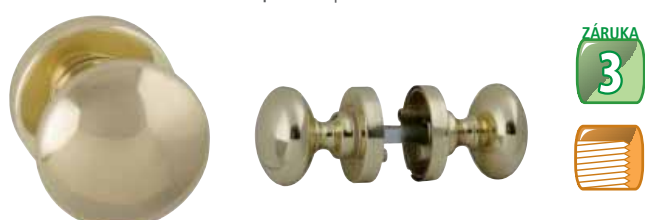

	Cena		
	bez DPH €	s DPH €	s DPH SK
<i>Made in Italy</i> guľa pevná (kus)	15,06	17,92	540,-
guľa pevná / guľa pevná pár	25,08	29,84	899,-
guľa pevná / guľa otočná pár	25,08	29,84	899,-
guľa otočná / guľa otočná pár	20,92	24,89	750,-

*

GUĽA FIXA - 50mm

povrch | OLS - Mosadz brúsená a lakovaná

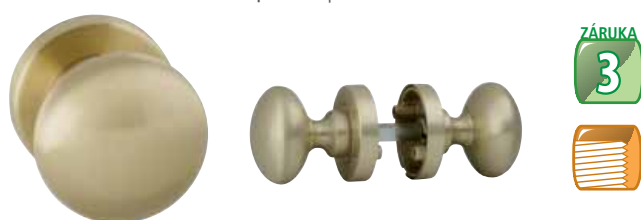

	Cena		
	bez DPH €	s DPH €	s DPH SK
<i>Made in Italy</i> guľa pevná (kus)	15,06	17,92	540,-
guľa pevná / guľa pevná pár	25,08	29,84	899,-
guľa pevná / guľa otočná pár	25,08	29,84	899,-
guľa otočná / guľa otočná pár	20,92	24,89	750,-

*

* Vyobrazené rozety nie sú súčasťou balenia. Je možné ich objednať samostatne. Ceny nájdete v katalógu na stránke s rozetami (str.112).

GUĽA SFÉRA - 60mm

povrch | OC - Chróm lesklý

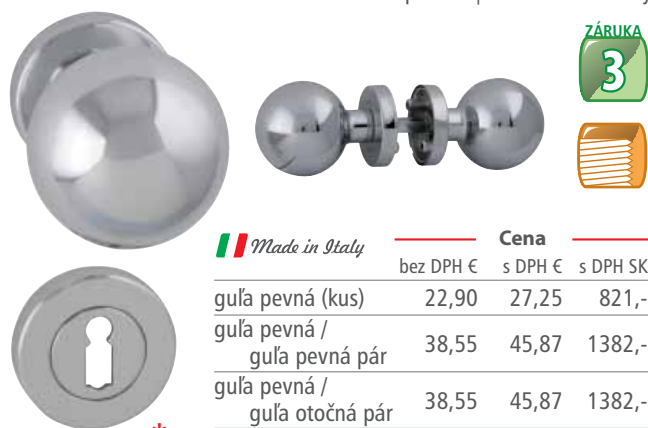

ZÁRUKA
3



	Cena		
	bez DPH €	s DPH €	s DPH SK
<i>Italy</i> guľa pevná (kus)	22,90	27,25	821,-
guľa pevná / guľa pevná pár	38,55	45,87	1382,-
guľa pevná / guľa otočná pár	38,55	45,87	1382,-
guľa otočná / guľa otočná pár	31,27	37,21	1121,-

*

GUĽA SFÉRA - 60mm

povrch | OCS - Chróm brúsený



ZÁRUKA
3



	Cena		
	bez DPH €	s DPH €	s DPH SK
<i>Italy</i> guľa pevná (kus)	22,90	27,25	821,-
guľa pevná / guľa pevná pár	38,55	45,87	1382,-
guľa pevná / guľa otočná pár	38,55	45,87	1382,-
guľa otočná / guľa otočná pár	31,27	37,21	1121,-

*

GUĽA SFÉRA - 60mm

povrch | ONS - Nikel brúsený

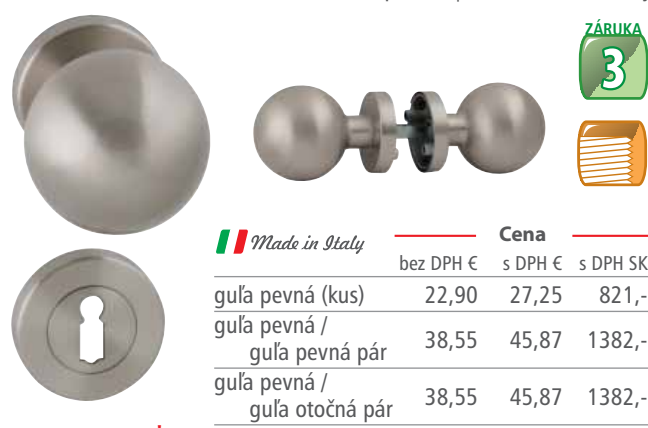

ZÁRUKA
3



	Cena		
	bez DPH €	s DPH €	s DPH SK
<i>Italy</i> guľa pevná (kus)	22,90	27,25	821,-
guľa pevná / guľa pevná pár	38,55	45,87	1382,-
guľa pevná / guľa otočná pár	38,55	45,87	1382,-
guľa otočná / guľa otočná pár	31,27	37,21	1121,-

*

GUĽA SFÉRA - 60mm

povrch | OGS - Bronz česaný mat

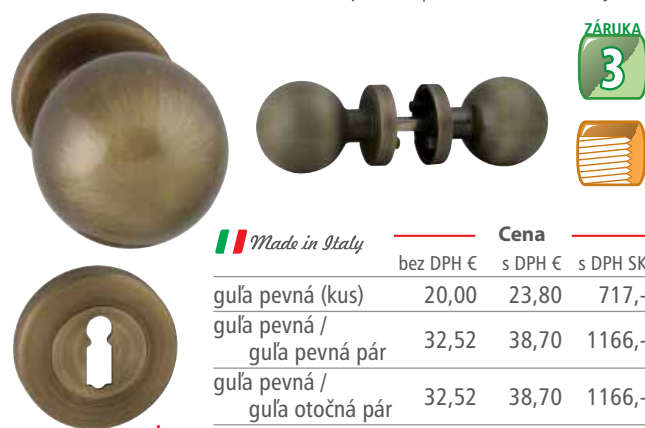

ZÁRUKA
3



	Cena		
	bez DPH €	s DPH €	s DPH SK
<i>Italy</i> guľa pevná (kus)	20,00	23,80	717,-
guľa pevná / guľa pevná pár	32,52	38,70	1166,-
guľa pevná / guľa otočná pár	32,52	38,70	1166,-
guľa otočná / guľa otočná pár	25,02	29,77	897,-

*

GUĽA SFÉRA - 60mm

povrch | OLV - Mosadz leštená a lakovaná

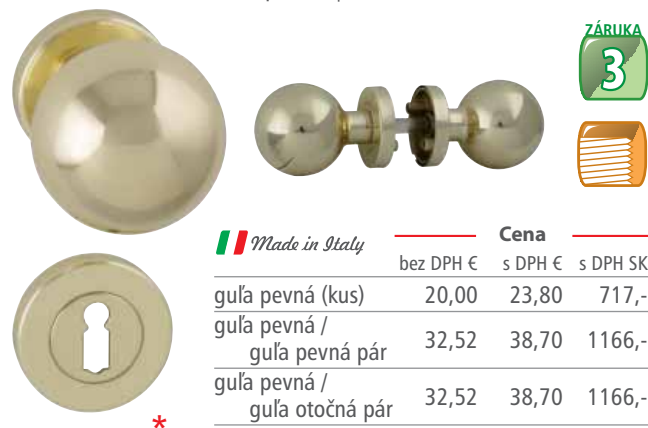

ZÁRUKA
3



	Cena		
	bez DPH €	s DPH €	s DPH SK
<i>Italy</i> guľa pevná (kus)	20,00	23,80	717,-
guľa pevná / guľa pevná pár	32,52	38,70	1166,-
guľa pevná / guľa otočná pár	32,52	38,70	1166,-
guľa otočná / guľa otočná pár	25,02	29,77	897,-

*

GUĽA SFÉRA - 60mm

povrch | OLS - Mosadz brúsená a lakovaná

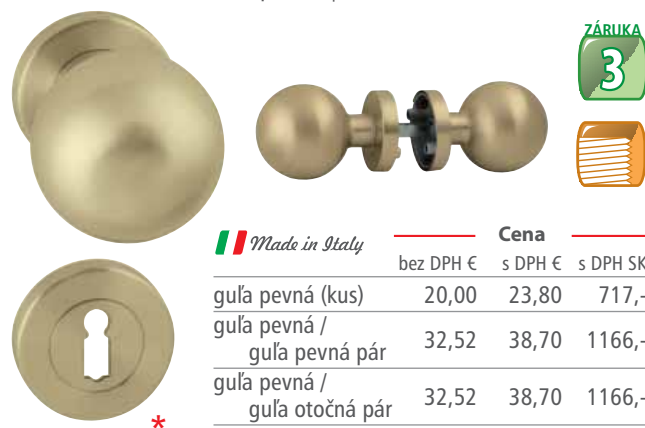

ZÁRUKA
3



	Cena		
	bez DPH €	s DPH €	s DPH SK
<i>Italy</i> guľa pevná (kus)	20,00	23,80	717,-
guľa pevná / guľa pevná pár	32,52	38,70	1166,-
guľa pevná / guľa otočná pár	32,52	38,70	1166,-
guľa otočná / guľa otočná pár	25,02	29,77	897,-

*

* Vyobrazené rozety nie sú súčasťou balenia. Je možné ich objednať samostatne. Ceny nájdete v katalógu na stránke s rozetami (str.112).

MADLO - HR 1924 Q

povrch | VONS - Velvet nikel (51)

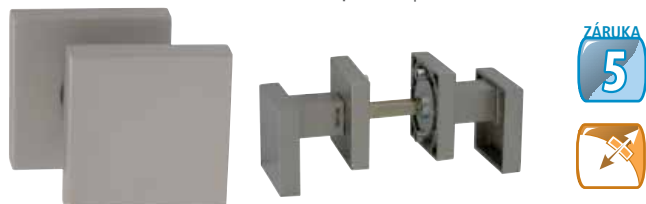

ZÁRUKA
5



*



TUPAI

	Cena		
	bez DPH €	s DPH €	s DPH SK
madlo pevné (kus)	29,15	34,69	1045,-
madlo pevné / madlo pevné pár	49,29	58,65	1767,-
madlo pevné / madlo otočné pár	49,29	58,65	1767,-
madlo otočné / madlo otočné pár	49,29	58,65	1767,-

MADLO - HR 1924 Q

povrch | OCS - Chróm brúsený (96)



ZÁRUKA
5



*



TUPAI

	Cena		
	bez DPH €	s DPH €	s DPH SK
madlo pevné (kus)	29,15	34,69	1045,-
madlo pevné / madlo pevné pár	49,29	58,65	1767,-
madlo pevné / madlo otočné pár	49,29	58,65	1767,-
madlo otočné / madlo otočné pár	49,29	58,65	1767,-

MADLO - HR 1924 Q

povrch | OC - Chróm lesklý (03)

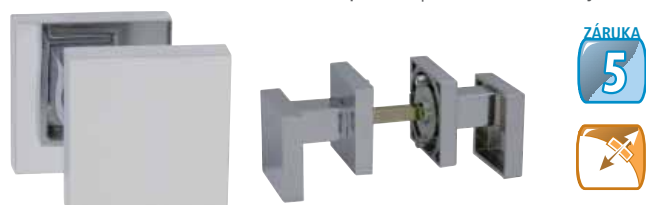

ZÁRUKA
5



*



TUPAI

	Cena		
	bez DPH €	s DPH €	s DPH SK
madlo pevné (kus)	29,15	34,69	1045,-
madlo pevné / madlo pevné pár	49,29	58,65	1767,-
madlo pevné / madlo otočné pár	49,29	58,65	1767,-
madlo otočné / madlo otočné pár	49,29	58,65	1767,-

MADLO - HR 1924 Q

povrch | VOC - Velvet chróm (52)



ZÁRUKA
5



*



TUPAI

	Cena		
	bez DPH €	s DPH €	s DPH SK
madlo pevné (kus)	29,15	34,69	1045,-
madlo pevné / madlo pevné pár	49,29	58,65	1767,-
madlo pevné / madlo otočné pár	49,29	58,65	1767,-
madlo otočné / madlo otočné pár	49,29	58,65	1767,-

MADLO - HR 1924 Q

povrch | ONS - Nikel brúsený (36)

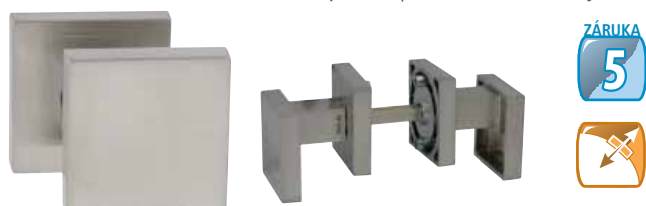

ZÁRUKA
5



*



TUPAI

	Cena		
	bez DPH €	s DPH €	s DPH SK
madlo pevné (kus)	29,15	34,69	1045,-
madlo pevné / madlo pevné pár	49,29	58,65	1767,-
madlo pevné / madlo otočné pár	49,29	58,65	1767,-
madlo otočné / madlo otočné pár	49,29	58,65	1767,-

MADLO - HR 1924 Q

povrch | BVOC - Čierny velvet chróm (128)

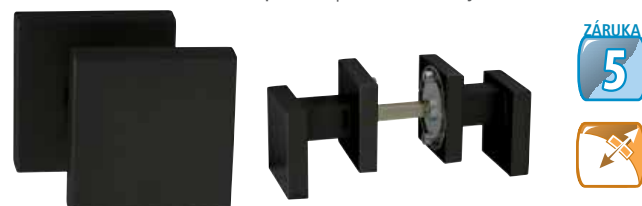

ZÁRUKA
5



*



TUPAI

	Cena		
	bez DPH €	s DPH €	s DPH SK
madlo pevné (kus)	29,15	34,69	1045,-
madlo pevné / madlo pevné pár	49,29	58,65	1767,-
madlo pevné / madlo otočné pár	49,29	58,65	1767,-
madlo otočné / madlo otočné pár	49,29	58,65	1767,-

Tieto madlá sú použité ako štandard pri modeloch TUPAI HR madlo/kľučka.

* Vyobrazené rozety nie sú súčasťou balenia. Je možné ich objednať samostatne. Ceny nájdete v katalógu na stránke s rozetami (str.111).

CUBE - HR 2734 Q (52 x 52)

povrch | VONS - Velvet nikl (51)



TUPAI

	Cena		
	bez DPH €	s DPH €	s DPH SK
BB-otvor pre kľúč	49,32	58,69	1768,-
PZ-otvor pre vložku	49,32	58,69	1768,-
sada s WC kľúčom	57,27	68,15	2053,-
madlo pevné kus	29,73	35,38	1066,-

CUBE - HR 2734 Q (52 x 52)

povrch | OC - Chróm lesklý (03)



TUPAI

	Cena		
	bez DPH €	s DPH €	s DPH SK
BB-otvor pre kľúč	49,32	58,69	1768,-
PZ-otvor pre vložku	49,32	58,69	1768,-
sada s WC kľúčom	57,27	68,15	2053,-
madlo pevné kus	29,73	35,38	1066,-

CUBE - HR 2734 Q (52 x 52)

povrch | OCS - Chróm brúsený (96)



TUPAI

	Cena		
	bez DPH €	s DPH €	s DPH SK
BB-otvor pre kľúč	49,32	58,69	1768,-
PZ-otvor pre vložku	49,32	58,69	1768,-
sada s WC kľúčom	57,27	68,15	2053,-
madlo pevné kus	29,73	35,38	1066,-

CUBE - HR 2734 Q (52 x 52)

povrch | ONS - Nikel brúsený (36)



TUPAI

	Cena		
	bez DPH €	s DPH €	s DPH SK
BB-otvor pre kľúč	49,32	58,69	1768,-
PZ-otvor pre vložku	49,32	58,69	1768,-
sada s WC kľúčom	57,27	68,15	2053,-
madlo pevné kus	29,73	35,38	1066,-

CUBE - HR 2734 Q (52 x 52)

povrch | BVOC - Čierny velvet chróm (128)



TUPAI

	Cena		
	bez DPH €	s DPH €	s DPH SK
BB-otvor pre kľúč	49,32	58,69	1768,-
PZ-otvor pre vložku	49,32	58,69	1768,-
sada s WC kľúčom	57,27	68,15	2053,-
madlo pevné kus	29,73	35,38	1066,-

CUBE - HR 2734 Q (52 x 52)

povrch | OC / BVOC
Chróm lesklý / čierny velvet chróm

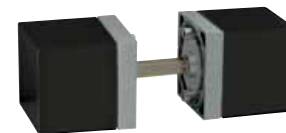

TUPAI

	Cena		
	bez DPH €	s DPH €	s DPH SK
BB-otvor pre kľúč	49,32	58,69	1768,-
PZ-otvor pre vložku	49,32	58,69	1768,-
sada s WC kľúčom	57,27	68,15	2053,-
madlo pevné kus	29,73	35,38	1066,-

Možnosti prevedenia - madlo pevné/madlo pevné, madlo otočné/madlo otočné, madlo pevné/madlo otočné

GUĽA 2006 Ø55 mm

povrch | N - Nerez (16)



	Cena		
	bez DPH €	s DPH €	s DPH SK
TUPAI guľa pevná (kus)	23,87	28,41	856,-
guľa pevná / guľa pevná pár	51,71	61,54	1854,-
guľa pevná / guľa otočná pár	51,71	61,54	1854,-
guľa otočná / guľa otočná pár	51,71	61,54	1854,-

*

GUĽA 2206 Ø55 mm

povrch | N - Nerez (16)

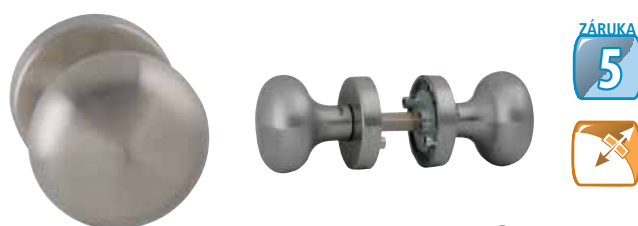

	Cena		
	bez DPH €	s DPH €	s DPH SK
TUPAI guľa pevná (kus)	37,21	44,28	1334,-
guľa pevná / guľa pevná pár	70,24	83,58	2518,-
guľa pevná / guľa otočná pár	70,24	83,58	2518,-
guľa otočná / guľa otočná pár	70,24	83,58	2518,-

*

GUĽA 2207 Ø50 mm

povrch | N - Nerez (16)



	Cena		
	bez DPH €	s DPH €	s DPH SK
TUPAI guľa pevná (kus)	36,15	43,02	1296,-
guľa pevná / guľa pevná pár	70,24	83,58	2518,-
guľa pevná / guľa otočná pár	70,24	83,58	2518,-
guľa otočná / guľa otočná pár	70,24	83,58	2518,-

*

GUĽA VYOSENÁ 2273 Ø55 mm

povrch | N - Nerez (16)



	Cena		
	bez DPH €	s DPH €	s DPH SK
TUPAI guľa pevná (kus)	23,87	28,41	856,-
guľa pevná / guľa pevná pár	49,07	58,39	1759,-
guľa pevná / guľa otočná pár	49,07	58,39	1759,-
guľa otočná / guľa otočná pár	49,07	58,39	1759,-

*

GUĽA VYOSENÁ 2209 Ø55 mm

povrch | N - Nerez (16)

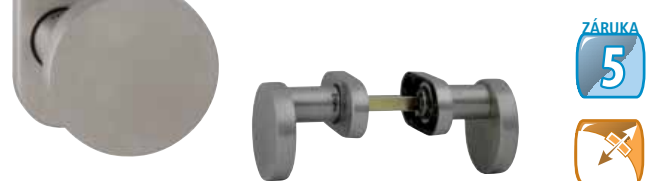

	Cena		
	bez DPH €	s DPH €	s DPH SK
TUPAI guľa pevná (kus)	23,87	28,41	856,-
guľa pevná / guľa pevná pár	49,07	58,39	1759,-
guľa pevná / guľa otočná pár	49,07	58,39	1759,-
guľa otočná / guľa otočná pár	49,07	58,39	1759,-

**

** Cenu rozety nájdete na strane 32.

MADLO 2210 Ø60 mm

povrch | N - Nerez masív (16)



	Cena				
	priemer	kód	bez DPH €	s DPH €	s DPH SK
TUPAI madlo pevné	60mm	2210	38,16	45,41	1368,-

* Vyobrazené rozety nie sú súčasťou balenia. Je možné ich objednať samostatne. Ceny nájdete v katalógu na stránke s rozetami (str.108).

GUĽA VYOSENÁ OVÁL - 042L

povrch | N - Nerez



	Cena		
	bez DPH €	s DPH €	s DPH SK
guľa pevná / guľa pevná pár	92,50	110,07	3316,-
guľa pevná / guľa otočná pár	87,65	104,3	3142,-
guľa otočná / guľa otočná pár	82,79	98,52	2968,-

GUĽA VYOSENÁ - 042

povrch | N - Nerez



	Cena		
	bez DPH €	s DPH €	s DPH SK
guľa pevná / guľa pevná pár	91,52	108,91	3281,-
guľa pevná / guľa otočná pár	86,13	102,5	3088,-
guľa otočná / guľa otočná pár	80,81	96,16	2897,-

GUĽA + GUĽA 2229

povrch | N - Nerez (16)



	Cena		
	bez DPH €	s DPH €	s DPH SK
TUPAI so zámkom + 3 kľúče	19,89	23,67	713,-

ÚCHYTKA + ÚCHYTKA 2196

povrch | N - Nerez masív (16)

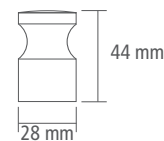
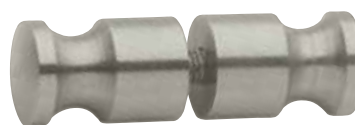

	Cena		
	bez DPH €	s DPH €	s DPH SK
TUPAI so závitom	14,59	17,36	523,-

ROZETA

povrch | N - Nerez (16)



	Cena		
	bez DPH €	s DPH €	s DPH SK
TUPAI 1. rozeta BB	6,13	7,30	220,-
2. rozeta PZ	6,13	7,30	220,-
3. záslepka	6,13	7,30	220,-
4. sada s WC kľúčom	10,40	12,38	373,-

NEREZOVÉ MADLO ATZ Q



1



2



3

MADLO PRISMA 1954 Q

TUPAI

kód	rozteč: dĺžka: hrúbka:			Cena		
	mm	mm	mm	bez DPH €	s DPH €	s DPH SK
8190/kus	300	400	30x30	81,14	96,56	2909,-
8190/pár	300	400	30x30	162,26	193,09	5817,-
8191/kus	400	600	30x30	86,64	103,1	3106,-
8191/pár	400	600	30x30	173,25	206,17	6211,-
8192/kus	1100	1400	30x30	116,87	139,08	4190,-
8192/pár	1100	1400	30x30	233,76	278,17	8380,-

TUPAI

kód	rozteč: dĺžka: hrúbka:			Cena		
	mm	mm	mm	bez DPH €	s DPH €	s DPH SK
1. OC/OCS - Chróm lesk/brús - kus	250	295	15x15	76,54	91,08	2744,-
1. OC/OCS - Chróm lesk/brús - pár	250	295	15x15	153,06	182,14	5487,-
2. VONS - Velvet nikel - kus	250	295	15x15	76,54	91,08	2744,-
2. VONS - Velvet nikel - pár	250	295	15x15	153,06	182,14	5487,-
3. OC / BVOC - kus	250	295	15x15	76,54	91,08	2744,-
3. OC / BVOC - pár	250	295	15x15	153,06	182,14	5487,-

NEREZOVÉ MADLO



sklon 30°

TUPAI

kód	rozteč: dĺžka: Ø			Cena		
	mm	mm	mm	bez DPH €	s DPH €	s DPH SK
2145/kus	203	305	30	55,01	65,46	1972,-
2145/pár	203	305	30	110,02	130,92	3944,-

SPOJOVACÍ MATERIÁL

povrch | N - Nerez (16)

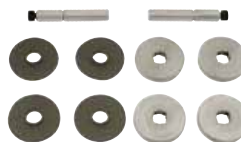

1



2

TUPAI

na hrúbku madla	Cena		
	bez DPH €	s DPH €	s DPH SK
1. na pár 20 mm	14,31	17,03	513,-
2. na kus 20 mm	11,66	13,88	418,-
1. na pár 25 mm	14,98	17,83	537,-
2. na kus 25 mm	13,75	16,36	493,-
1. na pár 30 mm	16,07	19,12	576,-
2. na kus 30 mm	12,72	15,14	456,-

NEREZOVÉ MADLO



TUPAI

rozteč: délka: Ø **Cena**

kód	mm	mm	mm	bez DPH €	s DPH €	s DPH SK
2931/kus	356	386	30	59,24	70,50	2124,-
2931/pár	356	386	30	118,50	141,01	4248,-

NEREZOVÉ MADLO



TUPAI

rozteč: délka: Ø **Cena**

kód	mm	mm	mm	bez DPH €	s DPH €	s DPH SK
2903/kus	305	330	25	32,24	38,37	1156,-
2903/pár	305	330	25	64,49	76,74	2312,-
2906/kus	406	436	30	42,73	50,85	1532,-
2906/pár	406	436	30	85,47	101,71	3064,-
2908/kus	610	640	30	59,24	70,50	2124,-
2908/pár	610	640	30	118,50	141,01	4248,-

NEREZOVÉ MADLO



TUPAI

rozteč: délka: Ø **Cena**

kód	mm	mm	mm	bez DPH €	s DPH €	s DPH SK
2969/kus	203	305	30	47,50	56,53	1703,-
2969/pár	203	305	30	95,01	113,06	3406,-
2938/kus	559	759	30	79,00	94,01	2832,-
2938/pár	559	759	30	157,99	188,01	5664,-
2939/kus	762	1062	30	95,51	113,66	3424,-
2939/pár	762	1062	30	190,99	227,28	6847,-

NEREZOVÉ MADLO



TUPAI

rozteč: délka: Ø **Cena**

kód	mm	mm	mm	bez DPH €	s DPH €	s DPH SK
2924/kus	305	330	25	44,77	53,28	1605,-
2924/pár	305	330	25	89,51	106,52	3209,-
2925/kus	356	386	30	55,01	65,46	1972,-
2925/pár	356	386	30	109,98	130,88	3943,-

NEREZOVÉ MADLO PLNÝ MATERIÁL



TUPAI

rozteč: délka: Ø **Cena**

kód	mm	mm	mm	bez DPH €	s DPH €	s DPH SK
2951/kus	254	277	20	50,99	60,68	1828,-
2951/pár	254	277	20	101,98	121,36	3656,-

NEREZOVÉ MADLO



TUPAI

rozteč: délka: Ø **Cena**

kód	mm	mm	mm	bez DPH €	s DPH €	s DPH SK
2917/kus	305	330	25	44,02	52,38	1578,-
2917/pár	305	330	25	88,01	104,73	3155,-
2920/kus	406	436	30	56,51	67,25	2026,-
2920/pár	406	436	30	113,00	134,47	4051,-
2921/kus	508	538	30	64,74	77,04	2321,-
2921/pár	508	538	30	129,49	154,09	4642,-
2922/kus	610	640	30	73,00	86,87	2617,-
2922/pár	610	640	30	146,00	173,74	5234,-

ROZETA - HR 52 x 52 mm

povrch | ONS - Nikel brúsený (36)



TUPAI

	Cena		
	bez DPH €	s DPH €	s DPH SK
BB-otvor pre kľúč pár	11,13	13,24	399,-
PZ-otvor pre vložku pár	11,13	13,24	399,-
sada s WC kľúčom	18,10	21,54	649,-

povrch | VONS - Velvet nikel (51)



TUPAI

	Cena		
	bez DPH €	s DPH €	s DPH SK
BB-otvor pre kľúč pár	11,13	13,24	399,-
PZ-otvor pre vložku pár	11,13	13,24	399,-
sada s WC kľúčom	18,10	21,54	649,-

povrch | OC - Chróm lesklý (03)



TUPAI

	Cena		
	bez DPH €	s DPH €	s DPH SK
BB-otvor pre kľúč pár	11,13	13,24	399,-
PZ-otvor pre vložku pár	11,13	13,24	399,-
sada s WC kľúčom	18,10	21,54	649,-

povrch | OCS - Chróm brúsený (96)



TUPAI

	Cena		
	bez DPH €	s DPH €	s DPH SK
BB-otvor pre kľúč pár	11,13	13,24	399,-
PZ-otvor pre vložku pár	11,13	13,24	399,-
sada s WC kľúčom pár	18,10	21,54	649,-

povrch | OGS - Bronz česaný mat (77)



TUPAI

	Cena		
	bez DPH €	s DPH €	s DPH SK
BB-otvor pre kľúč pár	11,13	13,24	399,-
PZ-otvor pre vložku pár	11,13	13,24	399,-
sada s WC kľúčom	18,10	21,54	649,-

povrch | BVOC – Čierny velvet chróm (128)



TUPAI

	Cena		
	bez DPH €	s DPH €	s DPH SK
BB-otvor pre kľúč pár	11,13	13,24	399,-
PZ-otvor pre vložku pár	11,13	13,24	399,-
sada s WC kľúčom	18,10	21,54	649,-

povrch | OC/BVOC – Chróm lesklý/čierny velvet chróm



TUPAI

	Cena		
	bez DPH €	s DPH €	s DPH SK
BB-otvor pre kľúč pár	11,13	13,24	399,-
PZ-otvor pre vložku pár	11,13	13,24	399,-
sada s WC kľúčom	18,10	21,54	649,-



ROZETA - R Ø 52 mm

povrch | OC - Chróm lesklý



Made in Italy

Cena

	bez DPH €	s DPH €	s DPH SK
BB-otvor pre kľúč pár	10,04	11,95	360,-
PZ-otvor pre vložku pár	10,04	11,95	360,-
sada s WC kľúčom	13,92	16,56	499,-

povrch | OCS - Chróm brúsený



Made in Italy

Cena

	bez DPH €	s DPH €	s DPH SK
BB-otvor pre kľúč pár	10,04	11,95	360,-
PZ-otvor pre vložku pár	10,04	11,95	360,-
sada s WC kľúčom	13,92	16,56	499,-

povrch | ONS - Nikel brúsený



Made in Italy

Cena

	bez DPH €	s DPH €	s DPH SK
BB-otvor pre kľúč pár	10,04	11,95	360,-
PZ-otvor pre vložku pár	10,04	11,95	360,-
sada s WC kľúčom	13,92	16,56	499,-

povrch | OLV - Mosadz leštená a lakovaná



Made in Italy

Cena

	bez DPH €	s DPH €	s DPH SK
BB-otvor pre kľúč pár	10,04	11,95	360,-
PZ-otvor pre vložku pár	10,04	11,95	360,-
sada s WC kľúčom	13,92	16,56	499,-

povrch | OLS - Mosadz brúsená a lakovaná



Made in Italy

Cena

	bez DPH €	s DPH €	s DPH SK
BB-otvor pre kľúč pár	10,04	11,95	360,-
PZ-otvor pre vložku pár	10,04	11,95	360,-
sada s WC kľúčom	13,92	16,56	499,-

povrch | OGS - Bronz česaný mat



Made in Italy

Cena

	bez DPH €	s DPH €	s DPH SK
BB-otvor pre kľúč pár	10,04	11,95	360,-
PZ-otvor pre vložku pár	10,04	11,95	360,-
sada s WC kľúčom	13,92	16,56	499,-

ROZETA - HR 50 x 50 mm



1

2

3

mariani

sada s WC kľúčom
1. OC - Chróm lesklý
2. ONS - Nikel brúsený
3. OGS - Bronz česaný mat

Rozeta - HR 50 x 50 mm MARIANI - uvedené rozety sú použité pri kľúčkách MARIANI strana 91-99 v prevedení „sada s WC kľúčom“.



PRÍDAVNÁ ROZETA 61mm

bez prekrytia vložky



AXA

Cena

povrchy	bez DPH €	s DPH €	s DPH SK
1. B - Biely komaxit	13,92	16,56	499,-
2. F1 - Prírodný elox	13,92	16,56	499,-
3. F2 - Šampáňo elox	13,92	16,56	499,-
4. F3 - Zlatý elox	13,92	16,56	499,-
5. F4 - Bronz elox	13,92	16,56	499,-
6. F9 - Nerez elox	13,92	16,56	499,-

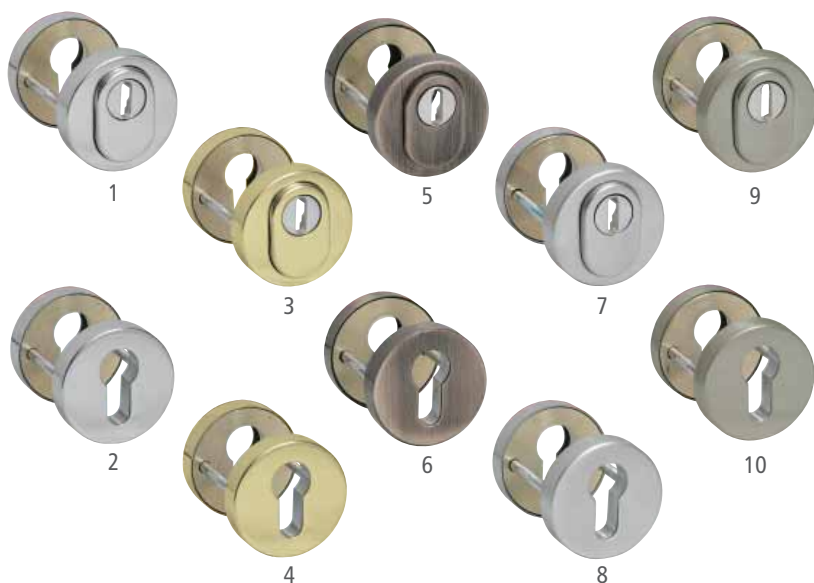

BEZPEČNOSTNÉ ROZETY - R



mariani

Cena

povrchy	bez DPH €	s DPH €	s DPH SK
1. OC -Chróm lesklý / PLUS	56,51	67,25	2026,-
2. OC -Chróm lesklý	38,75	46,11	1389,-
3. OLV -Mosadz lesklá / PLUS	52,30	62,24	1875,-
4. OLV -Mosadz lesklá	34,53	41,09	1238,-
5. OGR -Bronz česaný / PLUS	52,30	62,24	1875,-
6. OGR -Bronz česaný	34,53	41,09	1238,-
7. OCS -Chróm brúsený /PLUS	55,87	66,49	2003,-
8. OCS -Chróm brúsený	38,08	45,31	1365,-
9. N -Nerez / PLUS	49,51	58,92	1775,-
10. N -Nerez	33,72	40,13	1209,-

PLUS - označuje prekrytie vložky

BEZPEČNOSTNÉ ROZETY QB SECUR - HR



mariani

Cena

povrchy	bez DPH €	s DPH €	s DPH SK
1. OC -Chróm lesklý / PLUS	60,64	72,16	2174,-
2. OC -Chróm lesklý	40,76	48,50	1461,-
3. OLV -Mosadz lesklá / PLUS	56,43	67,15	2023,-
4. OLV -Mosadz lesklá	37,85	45,04	1357,-
5. OGR -Bronz česaný / PLUS	56,43	67,15	2023,-
6. OGR -Bronz česaný	37,85	45,04	1357,-
7. ONS -Nikel brúsený /PLUS	61,87	73,62	2218,-
8. ONS -Nikel brúsený	41,62	49,53	1492,-
9. OCS -Chróm brúsený /PLUS	60,64	72,16	2174,-
10. OCS -Chróm brúsený	40,76	48,50	1461,-
11. PVD INOX / PLUS	67,31	80,10	2413,-
12. PVD INOX	45,41	54,04	1628,-
13. PVD ZLATÁ / PLUS	65,35	77,77	2343,-
14. PVD ZLATÁ	45,41	54,04	1628,-

PLUS - označuje prekrytie vložky

bezpečnostné kovanie

TEKNO

ZÁRUKA
5



b.t. 3

Italy Made in

Cena

povrchy	bez DPH €	s DPH €	s DPH SK
OC - Chróm lesklý	199,28	237,14	7144,-
OCS - Chróm brúsený	204,08	242,85	7316,-
ONS - Nikel matný	207,17	246,53	7427,-
PVD ZLATÁ	231,27	275,21	8291,-

Prevedenie: madlo/kľučka alebo kľučka/kľučka

Rozteče: 90, 92 mm



OC

OCS

ONS

PVD



OC



PVD

ZÁRUKA
10



bezpečnostné kovanie GEGE 2600 AK

ZÁRUKA
5



b.t. 3

KABA

Cena

	bez DPH €	s DPH €	s DPH SK
kľučka/kľučka PLUS OCS	220,36	262,23	7900,-
madlo/ kľučka PLUS OCS	220,36	262,23	7900,-
kľučka/kľučka PLUS Tmavý bronz	220,36	262,23	7900,-
madlo/ kľučka PLUS Tmavý bronz	220,36	262,23	7900,-

Rozteče: 72, 90, 92 mm



bezpečnostné kovanie hliníkové

LINIA ATLAS

povrch | F1 - prírodný elox



AXA

	Cena		
	bez DPH €	s DPH €	s DPH SK
kľučka / kľučka	36,24	43,12	1299,-
madlo / kľučka	36,24	43,12	1299,-
prídavná rozeta	15,62	18,59	560,-
kľučka / kľučka PLUS	46,45	55,27	1665,-
madlo / kľučka PLUS	46,45	55,27	1665,-
prídavná rozeta PLUS	24,69	29,38	885,-

PLUS - označuje prekrytie vložky

Rozteče: 72, 90, 92 mm

bezpečnostné kovanie hliníkové

LINIA ATLAS

povrch | F2 - šampáno elox



AXA

	Cena		
	bez DPH €	s DPH €	s DPH SK
kľučka / kľučka	36,24	43,12	1299,-
madlo / kľučka	36,24	43,12	1299,-
prídavná rozeta	15,62	18,59	560,-
kľučka / kľučka PLUS	46,45	55,27	1665,-
madlo / kľučka PLUS	46,45	55,27	1665,-
prídavná rozeta PLUS	24,69	29,38	885,-

PLUS - označuje prekrytie vložky

Rozteče: 72, 90, 92 mm

bezpečnostné kovanie hliníkové

LINIA ATLAS

povrch | F3 - zlatý elox



AXA

	Cena		
	bez DPH €	s DPH €	s DPH SK
kľučka / kľučka	36,24	43,12	1299,-
madlo / kľučka	36,24	43,12	1299,-
prídavná rozeta	15,62	18,59	560,-
kľučka / kľučka PLUS	46,45	55,27	1665,-
madlo / kľučka PLUS	46,45	55,27	1665,-
prídavná rozeta PLUS	24,69	29,38	885,-

PLUS - označuje prekrytie vložky

Rozteče: 72, 90, 92 mm



bezpečnostné kovanie hliníkové

LINIA ATLAS

povrch | F4 - bronz elox



AXA

	Cena		
	bez DPH €	s DPH €	s DPH SK
kľučka / kľučka	36,24	43,12	1299,-
madlo / kľučka	36,24	43,12	1299,-
prídavná rozeta	15,62	18,59	560,-
kľučka / kľučka PLUS	46,45	55,27	1665,-
madlo / kľučka PLUS	46,45	55,27	1665,-
prídavná rozeta PLUS	24,69	29,38	885,-

PLUS - označuje prekrytie vložky

Rozteče: 72, 90, 92 mm

bezpečnostné kovanie hliníkové

LINIA ATLAS

povrch | F9 - nerez elox



AXA

	Cena		
	bez DPH €	s DPH €	s DPH SK
kľučka / kľučka	36,24	43,12	1299,-
madlo / kľučka	36,24	43,12	1299,-
prídavná rozeta	15,62	18,59	560,-
kľučka / kľučka PLUS	46,45	55,27	1665,-
madlo / kľučka PLUS	46,45	55,27	1665,-
prídavná rozeta PLUS	24,69	29,38	885,-

PLUS - označuje prekrytie vložky

Rozteče: 72, 90, 92 mm

bezpečnostné kovanie hliníkové

LINIA ATLAS

povrch | B - biely komaxit



AXA

	Cena		
	bez DPH €	s DPH €	s DPH SK
kľučka / kľučka	36,24	43,12	1299,-
madlo / kľučka	36,24	43,12	1299,-
prídavná rozeta	15,62	18,59	560,-
kľučka / kľučka PLUS	46,45	55,27	1665,-
madlo / kľučka PLUS	46,45	55,27	1665,-
prídavná rozeta PLUS	24,69	29,38	885,-

PLUS - označuje prekrytie vložky

Rozteče: 72, 90, 92 mm



bezpečnostné kovanie hliníkové

LINIA BETA

povrch | F1 - prírodný elox



AXA

Cena

	bez DPH €	s DPH €	s DPH SK
kľučka / kľučka	36,24	43,12	1299,-
madlo / kľučka	36,24	43,12	1299,-
prídavná rozeta	15,62	18,59	560,-
kľučka / kľučka PLUS	46,45	55,27	1665,-
madlo / kľučka PLUS	46,45	55,27	1665,-
prídavná rozeta PLUS	24,69	29,38	885,-

PLUS - označuje prekrytie vložky

Rozteče: 72, 90, 92 mm

bezpečnostné kovanie hliníkové

LINIA BETA

povrch | F2 - šampáňo elox



AXA

Cena

	bez DPH €	s DPH €	s DPH SK
kľučka / kľučka	36,24	43,12	1299,-
madlo / kľučka	36,24	43,12	1299,-
prídavná rozeta	15,62	18,59	560,-
kľučka / kľučka PLUS	46,45	55,27	1665,-
madlo / kľučka PLUS	46,45	55,27	1665,-
prídavná rozeta PLUS	24,69	29,38	885,-

PLUS - označuje prekrytie vložky

Rozteče: 72, 90, 92 mm

bezpečnostné kovanie hliníkové

LINIA BETA

povrch | F3 - zlatý elox



AXA

Cena

	bez DPH €	s DPH €	s DPH SK
kľučka / kľučka	36,24	43,12	1299,-
madlo / kľučka	36,24	43,12	1299,-
prídavná rozeta	15,62	18,59	560,-
kľučka / kľučka PLUS	46,45	55,27	1665,-
madlo / kľučka PLUS	46,45	55,27	1665,-
prídavná rozeta PLUS	24,69	29,38	885,-

PLUS - označuje prekrytie vložky

Rozteče: 72, 90, 92 mm



bezpečnostné kovanie hliníkové

LINIA BETA

povrch | F4 - bronz elox



AXA

Cena

	bez DPH €	s DPH €	s DPH SK
kľučka / kľučka	36,24	43,12	1299,-
madlo / kľučka	36,24	43,12	1299,-
prídavná rozeta	15,62	18,59	560,-
kľučka / kľučka PLUS	46,45	55,27	1665,-
madlo / kľučka PLUS	46,45	55,27	1665,-
prídavná rozeta PLUS	24,69	29,38	885,-

PLUS - označuje prekrytie vložky

Rozteče: 72, 90, 92 mm

bezpečnostné kovanie hliníkové

LINIA BETA

povrch | F9 - nerez elox



AXA

Cena

	bez DPH €	s DPH €	s DPH SK
kľučka / kľučka	36,24	43,12	1299,-
madlo / kľučka	36,24	43,12	1299,-
prídavná rozeta	15,62	18,59	560,-
kľučka / kľučka PLUS	46,45	55,27	1665,-
madlo / kľučka PLUS	46,45	55,27	1665,-
prídavná rozeta PLUS	24,69	29,38	885,-

PLUS - označuje prekrytie vložky

Rozteče: 72, 90, 92 mm

bezpečnostné kovanie hliníkové

LINIA BETA

povrch | B - biely komaxit



AXA

Cena

	bez DPH €	s DPH €	s DPH SK
kľučka / kľučka	36,24	43,12	1299,-
madlo / kľučka	36,24	43,12	1299,-
prídavná rozeta	15,62	18,59	560,-
kľučka / kľučka PLUS	46,45	55,27	1665,-
madlo / kľučka PLUS	46,45	55,27	1665,-
prídavná rozeta PLUS	24,69	29,38	885,-

PLUS - označuje prekrytie vložky

Rozteče: 72, 90, 92 mm



bezpečnostné kovanie hliníkové

ŠTANDARD

povrch | F1 - Prírodný elox



Made in Italy

Cena

	bez DPH €	s DPH €	s DPH SK
kľučka / kľučka	25,24	30,04	905,-
madlo / kľučka	25,24	30,04	905,-
kľučka / kľučka PLUS	33,30	39,63	1194,-
madlo / kľučka PLUS	33,30	39,63	1194,-

PLUS - označuje prekrytie vložky

Rozteče: 72, 90 mm



bezpečnostné kovanie hliníkové

ŠTANDARD

povrch | F4 - Bronz elox



Made in Italy

Cena

	bez DPH €	s DPH €	s DPH SK
kľučka / kľučka	25,24	30,04	905,-
madlo / kľučka	25,24	30,04	905,-
kľučka / kľučka PLUS	33,30	39,63	1194,-
madlo / kľučka PLUS	33,30	39,63	1194,-

PLUS - označuje prekrytie vložky

Rozteče: 72, 90 mm



spevnené bezpečnostné kovanie

INOX 2035

povrch | N - Nerez



Cena

	bez DPH €	s DPH €	s DPH SK
kľučka / kľučka	92,50	110,07	3316,-
madlo / kľučka	120,25	143,10	4311,-

Rozteč: 92 mm



bezpečnostné kovanie hliníkové

LINIA PRESTIGE

povrch | F1 - prírodný elox

AXA

Cena

	bez DPH €	s DPH €	s DPH SK
kľučka / kľučka	50,18	59,72	1799,-
madlo / kľučka	52,58	62,57	1885,-
prídavná rozeta	24,46	29,11	877,-
kľučka / kľučka PLUS	57,35	68,25	2056,-
madlo / kľučka PLUS	60,25	71,70	2160,-
prídavná rozeta PLUS	31,55	37,54	1131,-

PLUS - označuje prekrytie vložky

Rozteče: 72, 90, 92 mm

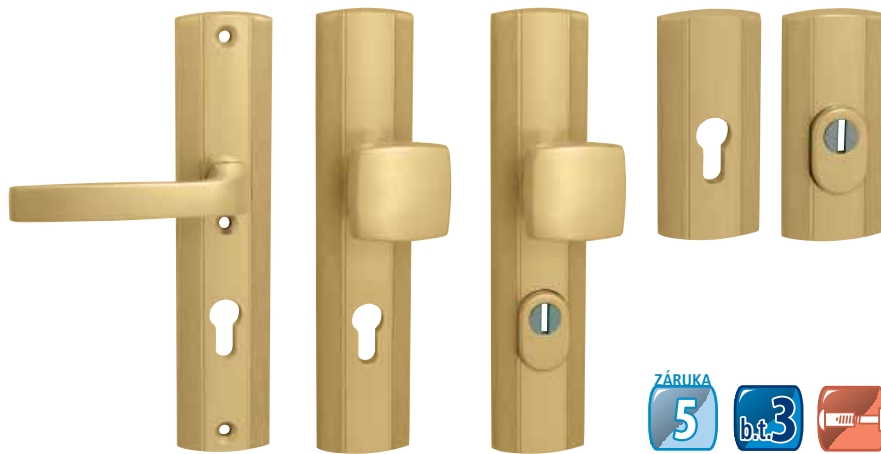

bezpečnostné kovanie hliníkové

LINIA PRESTIGE

povrch | F3 - zlatý elox

AXA

Cena

	bez DPH €	s DPH €	s DPH SK
kľučka / kľučka	50,18	59,72	1799,-
madlo / kľučka	52,58	62,57	1885,-
prídavná rozeta	24,46	29,11	877,-
kľučka / kľučka PLUS	57,35	68,25	2056,-
madlo / kľučka PLUS	60,25	71,70	2160,-
prídavná rozeta PLUS	31,55	37,54	1131,-

PLUS - označuje prekrytie vložky

Rozteče: 72, 90, 92 mm



bezpečnostné kovanie hliníkové

LINIA PRESTIGE

povrch | F4 - bronz elox

AXA

Cena

	bez DPH €	s DPH €	s DPH SK
kľučka / kľučka	50,18	59,72	1799,-
madlo / kľučka	52,58	62,57	1885,-
prídavná rozeta	24,46	29,11	877,-
kľučka / kľučka PLUS	57,35	68,25	2056,-
madlo / kľučka PLUS	60,25	71,70	2160,-
prídavná rozeta PLUS	31,55	37,54	1131,-

PLUS - označuje prekrytie vložky

Rozteče: 72, 90, 92 mm



bezpečnostné kovanie hliníkové

LINIA PRESTIGE

povrch | F9 - nerez elox

AXA

Cena

	bez DPH €	s DPH €	s DPH SK
kľučka / kľučka	50,18	59,72	1799,-
madlo / kľučka	52,58	62,57	1885,-
prídavná rozeta	24,46	29,11	877,-
kľučka / kľučka PLUS	57,35	68,25	2056,-
madlo / kľučka PLUS	60,25	71,70	2160,-
prídavná rozeta PLUS	31,55	37,54	1131,-

PLUS - označuje prekrytie vložky

Rozteče: 72, 90, 92 mm



bezpečnostné kovanie

LYON

povrch | PVD ZLATÁ

ZÁRUKA
10



mariani

Cena

bez DPH € s DPH € s DPH SK

kľučka / kľučka	139,33	165,80	4995,-
madlo / kľučka	139,33	165,80	4995,-
kľučka / kľučka PLUS	183,82	218,75	6590,-
madlo / kľučka PLUS	183,82	218,75	6590,-

PLUS - označuje prekrytie vložky

Rozteče: 72, 88, 90, 92 mm



bezpečnostné kovanie

LYON

povrch | OGS - Bronz česaný mat

ZÁRUKA
5



mariani

Cena

bez DPH € s DPH € s DPH SK

kľučka / kľučka	94,70	112,69	3395,-
madlo / kľučka	94,70	112,69	3395,-
kľučka / kľučka PLUS	138,35	164,64	4960,-
madlo / kľučka PLUS	138,35	164,64	4960,-

PLUS - označuje prekrytie vložky

Rozteče: 72, 88, 90, 92 mm



bezpečnostné kovanie

LYON

povrch | OCS - Chróm brúsený

ZÁRUKA
5



mariani

Cena

bez DPH € s DPH € s DPH SK

kľučka / kľučka	99,86	118,83	3580,-
madlo / kľučka	99,86	118,83	3580,-
kľučka / kľučka PLUS	144,77	172,28	5190,-
madlo / kľučka PLUS	144,77	172,28	5190,-

PLUS - označuje prekrytie vložky

Rozteče: 72, 88, 90, 92 mm

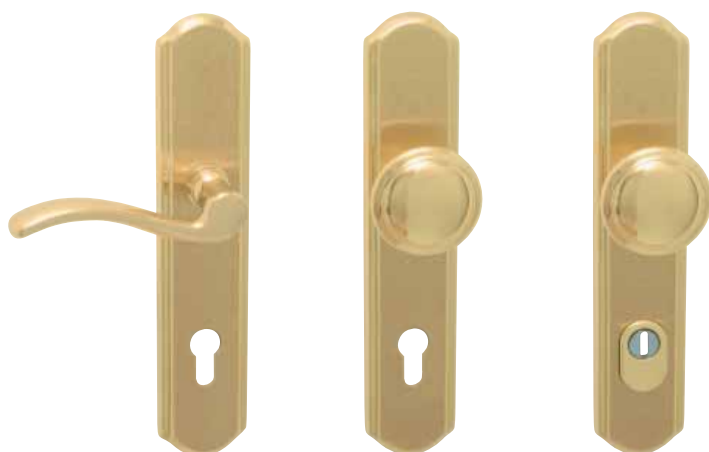

bezpečnostné kovanie

LYON

povrch | OLV/OLS - Mosadz leštená/Mosadz brúsená

ZÁRUKA
5



mariani

Cena

bez DPH € s DPH € s DPH SK

kľučka / kľučka	94,70	112,69	3395,-
madlo / kľučka	94,70	112,69	3395,-
kľučka / kľučka PLUS	138,35	164,64	4960,-
madlo / kľučka PLUS	138,35	164,64	4960,-

PLUS - označuje prekrytie vložky

Rozteče: 72, 88, 90, 92 mm



bezpečnostné kovanie

TORUS

povrch | OCS - Chróm brúsený



mariani

Cena

	bez DPH €	s DPH €	s DPH SK
kľučka / kľučka	99,03	117,84	3550,-
madlo / kľučka	99,03	117,84	3550,-
kľučka / kľučka PLUS	141,71	168,63	5080,-
madlo / kľučka PLUS	141,71	168,63	5080,-

PLUS - označuje prekrytie vložky
Rozteče: 72, 88, 90, 92 mm



bezpečnostné kovanie

TORUS

povrch | PVD ZLATÁ



mariani

Cena

	bez DPH €	s DPH €	s DPH SK
kľučka / kľučka	140,87	167,63	5050,-
madlo / kľučka	140,87	167,63	5050,-
kľučka / kľučka PLUS	184,10	219,08	6600,-
madlo / kľučka PLUS	184,10	219,08	6600,-

PLUS - označuje prekrytie vložky
Rozteče: 72, 88, 90, 92 mm



bezpečnostné kovanie

TORUS

povrch | OGS - Bronz česaný mat



mariani

Cena

	bez DPH €	s DPH €	s DPH SK
kľučka / kľučka	95,68	113,86	3430,-
madlo / kľučka	95,68	113,86	3430,-
kľučka / kľučka PLUS	137,24	163,31	4920,-
madlo / kľučka PLUS	137,24	163,31	4920,-

PLUS - označuje prekrytie vložky
Rozteče: 72, 88, 90, 92 mm



bezpečnostné kovanie

BREMA

povrch | N - Nerez



mariani

Cena

	bez DPH €	s DPH €	s DPH SK
kľučka / kľučka	136,13	161,99	4880,-
madlo / kľučka	136,13	161,99	4880,-
kľučka / kľučka PLUS	157,32	187,21	5640,-
madlo / kľučka PLUS	157,32	187,21	5640,-

PLUS - označuje prekrytie vložky
Rozteče: 72, 88, 90, 92 mm



bezpečnostné kovanie QB SECUR / ARTE

povrch | OGS - Bronz česaný mat



mariani

	Cena		
	bez DPH €	s DPH €	s DPH SK
kľučka / kľučka	120,50	143,40	4320,-
madlo / kľučka	120,50	143,40	4320,-
kľučka / kľučka PLUS	155,92	185,55	5590,-
madlo / kľučka PLUS	155,92	185,55	5590,-

PLUS - označuje prekrytie vložky

Rozteče: 72, 90, 92 mm



bezpečnostné QB SECUR / ARTE

povrch | PVD ZLATÁ



mariani

	Cena		
	bez DPH €	s DPH €	s DPH SK
kľučka / kľučka	186,61	222,07	6690,-
madlo / kľučka	186,61	222,07	6690,-
kľučka / kľučka PLUS	241,56	287,46	8660,-
madlo / kľučka PLUS	241,56	287,46	8660,-

PLUS - označuje prekrytie vložky

Rozteče: 72, 90, 92 mm



bezpečnostné kovanie QB SECUR / ARTE

povrch | PVD INOX



mariani

	Cena		
	bez DPH €	s DPH €	s DPH SK
kľučka / kľučka	186,61	222,07	6690,-
madlo / kľučka	186,61	222,07	6690,-
kľučka / kľučka PLUS	241,56	287,46	8660,-
madlo / kľučka PLUS	241,56	287,46	8660,-

PLUS - označuje prekrytie vložky

Rozteče: 72, 90, 92 mm



bezpečnostné kovanie QB SECUR - HR / ARTE

povrch | OGS - Bronz česaný mat



mariani

	Cena		
	bez DPH €	s DPH €	s DPH SK
kľučka / kľučka	126,64	150,70	4540,-
madlo / kľučka	126,64	150,70	4540,-
kľučka / kľučka PLUS	145,05	172,61	5200,-
madlo / kľučka PLUS	145,05	172,61	5200,-

PLUS - označuje prekrytie vložky



bezpečnostné kovanie QB SECUR - HR / ARTE

povrch | PVD ZLATÁ



mariani

	Cena		
	bez DPH €	s DPH €	s DPH SK
kľučka / kľučka	160,11	190,53	5740,-
madlo / kľučka	160,11	190,53	5740,-
kľučka / kľučka PLUS	182,15	216,76	6530,-
madlo / kľučka PLUS	182,15	216,76	6530,-

PLUS - označuje prekrytie vložky



bezpečnostné kovanie QB SECUR - HR / ARTE

povrch | PVD INOX



mariani

	Cena		
	bez DPH €	s DPH €	s DPH SK
kľučka / kľučka	160,11	190,53	5740,-
madlo / kľučka	160,11	190,53	5740,-
kľučka / kľučka PLUS	182,15	216,76	6530,-
madlo / kľučka PLUS	182,15	216,76	6530,-

PLUS - označuje prekrytie vložky



bezpečnostné kovanie QB SECUR / SUN 1

povrch | OGS - Bronz česaný mat



mariani

	Cena		
	bez DPH €	s DPH €	s DPH SK
kľučka / kľučka	120,50	143,40	4320,-
madlo / kľučka	120,50	143,40	4320,-
kľučka / kľučka PLUS	155,92	185,55	5590,-
madlo / kľučka PLUS	155,92	185,55	5590,-

PLUS - označuje prekrytie vložky
Rozteče: 72, 90, 92 mm



bezpečnostné kovanie QB SECUR / SUN 1

povrch | PVD INOX



mariani

	Cena		
	bez DPH €	s DPH €	s DPH SK
kľučka / kľučka	186,61	222,07	6690,-
madlo / kľučka	186,61	222,07	6690,-
kľučka / kľučka PLUS	241,56	287,46	8660,-
madlo / kľučka PLUS	241,56	287,46	8660,-

PLUS - označuje prekrytie vložky
Rozteče: 72, 90, 92 mm



Certifikát zhody pre bezpečnostné kľučky MARIANI SECUR QB

bezpečnostné kovanie
QB SECUR - HR / SUN 1

povrch | OGS - Bronz česaný mat



mariani

Cena

	bez DPH €	s DPH €	s DPH SK
klučka / kľučka	126,64	150,70	4540,-
madlo / kľučka	126,64	150,70	4540,-
klučka / kľučka PLUS	145,05	172,61	5200,-
madlo / kľučka PLUS	145,05	172,61	5200,-

PLUS - označuje prekrytie vložky

bezpečnostné kovanie
QB SECUR - HR / SUN 1

povrch | PVD INOX



mariani

Cena

	bez DPH €	s DPH €	s DPH SK
klučka / kľučka	160,11	190,53	5740,-
madlo / kľučka	160,11	190,53	5740,-
klučka / kľučka PLUS	182,15	216,76	6530,-
madlo / kľučka PLUS	182,15	216,76	6530,-

PLUS - označuje prekrytie vložky



Certifikát zhody pre bezpečnostné kľučky AXA
Linia ATLAS, Linia BETA, Linia DIVA, Linia PRESTIGE





/ ARTE
povrch | OC

bezpečnostné kovanie

QB SECUR /

povrch | OC - Chróm lesklý



mariani

	Cena		
	bez DPH €	s DPH €	s DPH SK
kľučka / kľučka	122,45	145,72	4390,-
madlo / kľučka	122,45	145,72	4390,-
kľučka / kľučka PLUS	157,88	187,88	5660,-
madlo / kľučka PLUS	157,88	187,88	5660,-

PLUS - označuje prekrytie vložky
Rozteče: 72, 90, 92 mm



/ ZENITH
povrch | OC



/ COMET
povrch | OC



/ COMET
povrch | OC / OC / OCS



/ SUN 1
povrch | OC



/ SUN 1
povrch | OC / OC / OCS



/ SUN 2
povrch | OC



/ SUN 3
povrch | OC



/ CLOUD
povrch | OC

Spôsob objednávania:

QB SECUR označuje štíty alebo štíty + madlo. Pri objednávke prosím uveďte za lomítkom model kľučky, ktorú ste si vybrali.

Príklad: QB SECUR / SUN 1 alebo QB SECUR / ZENITH

bezpečnostné kovanie

QB SECUR - HR /

povrch | OC - Chróm lesklý

/ ARTE

povrch | OC



mariani

	Cena		
	bez DPH €	s DPH €	s DPH SK
kľučka / kľučka	134,73	160,33	4830,-
madlo / kľučka	134,73	160,33	4830,-
kľučka / kľučka PLUS	154,53	183,89	5540,-
madlo / kľučka PLUS	154,53	183,89	5540,-

PLUS - označuje prekrytie vložky

/ ZENITH

povrch | OC



/ COMET

povrch | OC



/ COMET

povrch | OC / OC / OCS



/ SUN 1

povrch | OC



/ SUN 1

povrch | OC / OC / OCS



/ SUN 3

povrch | OC



/ SUN 2

povrch | OC



/ CLOUD

povrch | OC



Spôsob objednávania:

QB SECUR - HR označuje rozety alebo rozety s madlom. Pri objednávke prosím uveďte za lomítkom model kľučky, ktorú ste si vybrali.

Príklad: QB SECUR - HR / SUN 3 alebo QB SECUR - HR / COMET

bezpečnostné kovanie

QB SECUR /

povrch | OCS - Chróm brúsený



/ ARTE

povrch | OCS

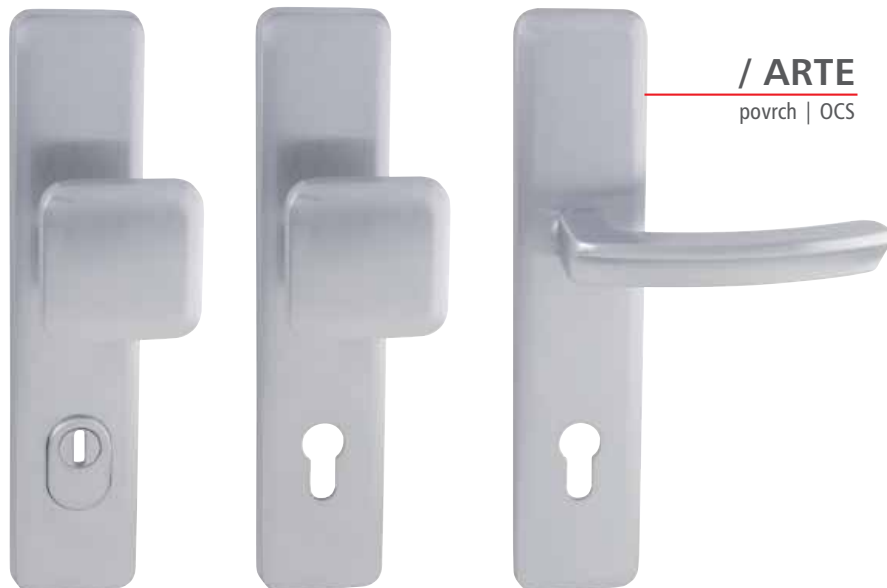

mariani

Cena

	bez DPH €	s DPH €	s DPH SK
kľučka / kľučka	122,45	145,72	4390,-
madlo / kľučka	122,45	145,72	4390,-
kľučka / kľučka PLUS	157,88	187,88	5660,-
madlo / kľučka PLUS	157,88	187,88	5660,-

PLUS - označuje prekrytie vložky

Rozteče: 72, 90, 92 mm

/ ZENITH

povrch | OCS



/ COMET

povrch | OCS



/ COMET

povrch | OCS / OC / OCS



/ SUN 1

povrch | OCS



/ SUN 1

povrch | OCS / OC / OCS



/ SUN 2

povrch | OCS



/ SUN 3

povrch | OCS



/ CLOUD

povrch | OCS



Spôsob objednávania:

QB SECUR označuje štíty alebo štíty + madlo. Pri objednávke prosím uveďte za lomítkom model kľučky, ktorú ste si vybrali.

Príklad: QB SECUR / SUN 1 alebo QB SECUR / ZENITH

bezpečnostné kovanie

QB SECUR - HR /

povrch | OCS - Chróm brúsený

/ ARTE

povrch | OCS



mariani

	Cena		
	bez DPH €	s DPH €	s DPH SK
kľučka / kľučka	134,73	160,33	4830,-
madlo / kľučka	134,73	160,33	4830,-
kľučka / kľučka PLUS	154,53	183,89	5540,-
madlo / kľučka PLUS	154,53	183,89	5540,-

PLUS - označuje prekrytie vložky

/ ZENITH

povrch | OCS



/ COMET

povrch | OCS



/ COMET

povrch | OCS / OC / OCS



/ SUN 1

povrch | OCS



/ SUN 1

povrch | OCS / OC / OCS



/ SUN 3

povrch | OCS



/ SUN 2

povrch | OCS



/ CLOUD

povrch | OCS



Spôsob objednávania:

QB SECUR - HR označuje rozety alebo rozety s madlom. Pri objednávke prosím uveďte za lomítkom model kľučky, ktorú ste si vybrali.

Príklad: QB SECUR - HR / SUN 3 alebo QB SECUR - HR / COMET

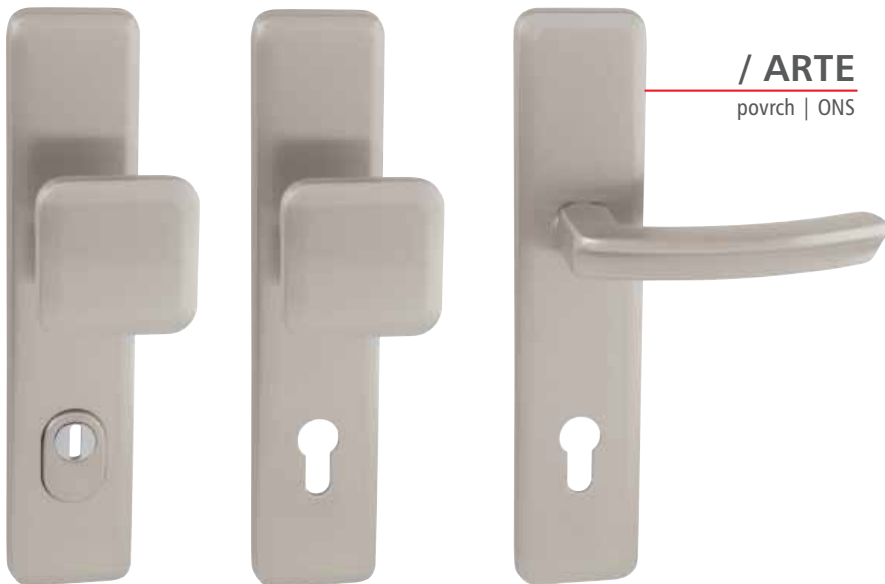

/ ARTE
povrch | ONS

bezpečnostné kovanie

QB SECUR /

povrch | ONS - Nikel brúsený



mariani

Cena

	bez DPH €	s DPH €	s DPH SK
kľučka / kľučka	126,08	150,04	4520,-
madlo / kľučka	126,08	150,04	4520,-
kľučka / kľučka PLUS	161,50	192,19	5790,-
madlo / kľučka PLUS	161,50	192,19	5790,-

PLUS - označuje prekrytie vložky

Rozteče: 72, 90, 92 mm



/ ZENITH
povrch | ONS



/ COMET
povrch | ONS



/ COMET
povrch | ONS / ONL / ONS



/ SUN 1
povrch | ONS



/ SUN 1
povrch | ONS / ONL / ONS



/ SUN 2
povrch | ONS



/ SUN 3
povrch | ONS



/ CLOUD
povrch | ONS

Spôsob objednávania:

QB SECUR označuje štíty alebo štíty + madlo. Pri objednávke prosím uveďte za lomítkom model kľučky, ktorú ste si vybrali.

Príklad: QB SECUR / SUN 1 alebo QB SECUR / ZENITH

bezpečnostné kovanie

QB SECUR - HR /

povrch | ONS - Nikel brúsený

/ ARTE

povrch | ONS



mariani

Cena

	bez DPH €	s DPH €	s DPH SK
kľučka / kľučka	138,08	164,31	4950,-
madlo / kľučka	138,08	164,31	4950,-
kľučka / kľučka PLUS	158,44	188,54	5680,-
madlo / kľučka PLUS	158,44	188,54	5680,-

PLUS - označuje prekrytie vložky

/ ZENITH

povrch | ONS

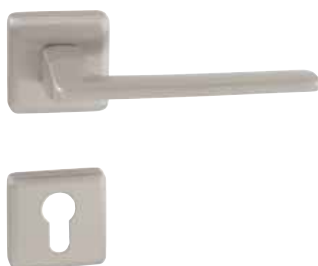

/ COMET

povrch | ONS / ONL / ONS

/ COMET

povrch | ONS

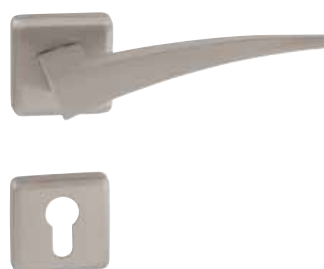

/ SUN 1

povrch | ONS



/ SUN 1

povrch | ONS / ONL / ONS



/ SUN 3

povrch | ONS



/ SUN 2

povrch | ONS

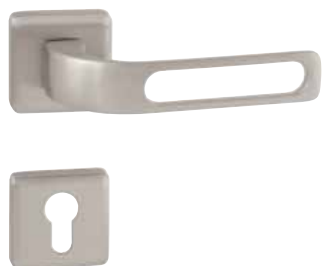

/ CLOUD

povrch | ONS



Spôsob objednávania:

QB SECUR - HR označuje rozety alebo rozety s madlom. Pri objednávke prosím uveďte za lomítkom model kľučky, ktorú ste si vybrali.

Príklad: QB SECUR - HR / SUN 3 alebo QB SECUR - HR / COMET

TILLY

povrch | Kovaná čierna



Cena

	bez DPH €	s DPH €	s DPH SK
klučka / klučka PZ	26,11	31,07	936,-
guľa / klučka PZ	50,07	59,58	1795,-
rozteče	72 a 90 mm		

TILLY

povrch | Kovaná sivá

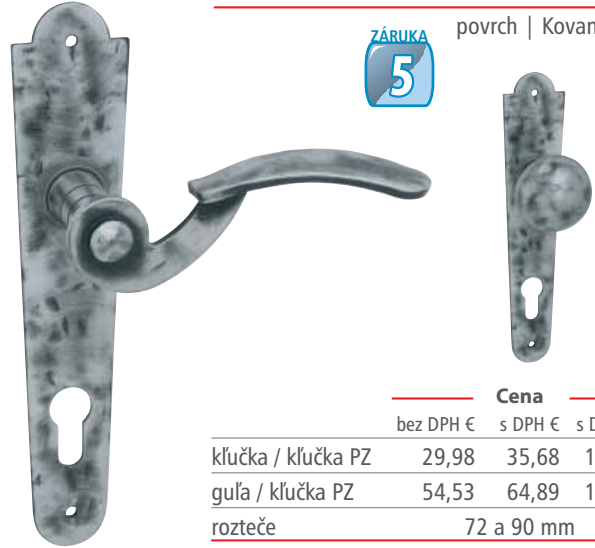

Cena

	bez DPH €	s DPH €	s DPH SK
klučka / klučka PZ	29,98	35,68	1075,-
guľa / klučka PZ	54,53	64,89	1955,-
rozteče	72 a 90 mm		

TILLY - R OVÁL

povrch | Kovaná čierna



Cena

	bez DPH €	s DPH €	s DPH SK
klučka / klučka PZ	26,11	31,07	936,-
madlo / klučka PZ	50,07	59,58	1795,-

TILLY - R OVÁL

povrch | Kovaná sivá



Cena

	bez DPH €	s DPH €	s DPH SK
klučka / klučka PZ	29,98	35,68	1075,-
madlo / klučka PZ	54,53	64,89	1955,-

TILLY - ÚZKY ŠTÍT

povrch | Kovaná čierna



prevedenie:

Cena

	bez DPH €	s DPH €	s DPH SK
klučka / klučka PZ			
kovaná čierna	35,90	42,72	1287,-
kovaná sivá	38,18	45,44	1369,-
rozteče	72 a 90 mm		

ALBAN

povrch | Kovaná sivá



Cena

	bez DPH €	s DPH €	s DPH SK
klučka / klučka PZ	124,21	147,81	4453,-
guľa / klučka PZ	149,07	177,39	5344,-
rozteče	72 a 90 mm		

URBAN

povrch | Kovaná sivá



Cena

	bez DPH €	s DPH €	s DPH SK
klučka / klučka PZ	57,35	68,25	2056,-
guľa / klučka PZ	66,55	79,20	2386,-
rozteče	72 a 90 mm		

AGAVE

povrch | Kovaná sivá

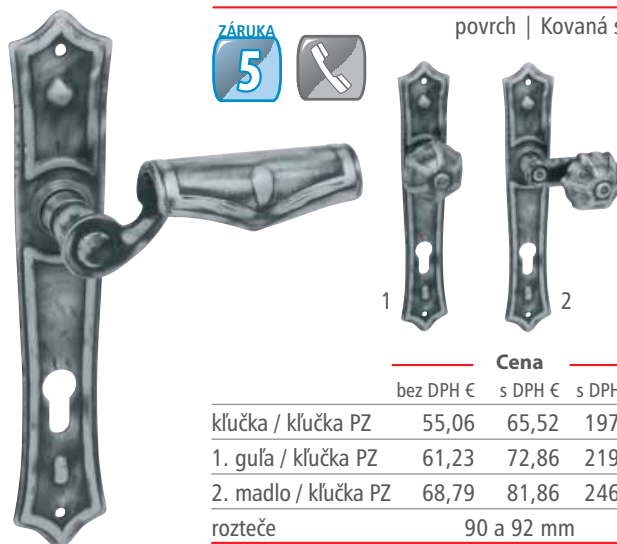

Cena

	bez DPH €	s DPH €	s DPH SK
klučka / klučka PZ	55,06	65,52	1974,-
1. guľa / klučka PZ	61,23	72,86	2195,-
2. madlo / klučka PZ	68,79	81,86	2466,-
rozteče	90 a 92 mm		

MADLO KNUT - R OVÁL

povrch | Kovaná sivá
Kovaná čierna



Cena

povrchy	bez DPH €	s DPH €	s DPH SK
1. Kovaná čierna	74,70	88,89	2678,-
2. Kovaná sivá	80,36	95,63	2881,-

MADLO PORT - R OVÁL

povrch | Kovaná sivá
Kovaná čierna



Cena

povrchy	bez DPH €	s DPH €	s DPH SK
1. Kovaná čierna	51,82	61,67	1858,-
2. Kovaná sivá	60,95	72,53	2185,-

SPEVNENÉ KOVANIE BREMEN

povrch | Kovaná sivočierna



Cena

	bez DPH €	s DPH €	s DPH SK
PZ-otvor pre vložku	88,01	104,73	3155,-
1. guľa / klučka PZ	88,01	104,73	3155,-
2. madlo / klučka PZ	94,50	112,46	3388,-
rozteče	90 a 92 mm		

SPEVNENÉ KOVANIE NÜRNBERG

povrch | Kovaná sivočierna



Cena

	bez DPH €	s DPH €	s DPH SK
klučka / klučka PZ	116,26	138,35	4168,-
1. guľa / klučka PZ	122,26	145,49	4383,-
2. madlo / klučka PZ	130,27	155,02	4670,-
rozteče	90 a 92 mm		

KONSTANZ

povrch | Kovaná sivočierna



	Cena		
	bez DPH €	s DPH €	s DPH SK
BB - otvor pre kľúč	25,77	30,67	924,-
rozteče	72 a 90 mm		

FLORENZ

povrch | Kovaná sivočierna



	Cena		
	bez DPH €	s DPH €	s DPH SK
BB - otvor pre kľúč	41,50	49,39	1488,-
rozteče	72 a 90 mm		

KONSTANZ

povrch | Kovaná sivočierna



	Cena		
	bez DPH €	s DPH €	s DPH SK
sada s WC kľúčom	41,50	49,39	1488,-
rozteče	72 a 90 mm		

FLORENZ

povrch | Kovaná sivočierna



	Cena		
	bez DPH €	s DPH €	s DPH SK
sada s WC kľúčom	57,27	68,15	2053,-
rozteče	72 a 90 mm		

KONSTANZ

povrch | Kovaná sivočierna



	Cena		
	bez DPH €	s DPH €	s DPH SK
klučka / klučka PZ	25,77	30,67	924,-
guľa / klučka PZ	25,77	30,67	924,-
rozteče	72 a 90 mm		

FLORENZ

povrch | Kovaná sivočierna

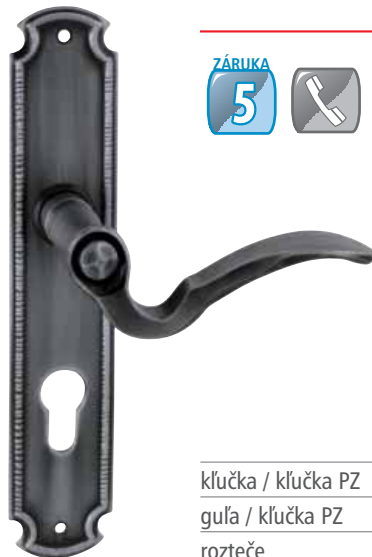

	Cena		
	bez DPH €	s DPH €	s DPH SK
klučka / klučka PZ	41,50	49,39	1488,-
guľa / klučka PZ	41,50	49,39	1488,-
rozteče	72 a 90 mm		

MICHAELA - OKENNÁ POLOLIVA



antik

všetky povrchy pololiva	Cena		
	bez DPH €	s DPH €	s DPH SK
	1,67	1,99	60,-

LUCIA - OKENNÁ POLOLIVA

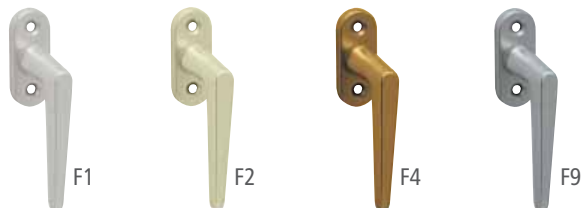

povrch	Cena		
	bez DPH €	s DPH €	s DPH SK
F1, F2, F4	2,96	3,52	106,-
F9	3,15	3,75	113,-

VIENNA - KĽUČKA NA EUROOKNO



povrch	Cena		
	bez DPH €	s DPH €	s DPH SK
F1, F4	5,55	6,61	199,-
F9	6,11	7,27	219,-

LUCIA - BALKÓNOVÁ KĽUČKA

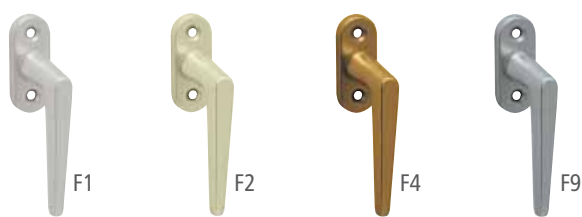

povrch	Cena		
	bez DPH €	s DPH €	s DPH SK
F1, F2, F4	3,04	3,62	109,-
F9	3,38	4,02	121,-

GARDA - KĽUČKA NA EUROOKNO



povrch	Cena		
	bez DPH €	s DPH €	s DPH SK
F1, F4	4,86	5,78	174,-
F9	5,08	6,04	182,-
AOC-pochrómovaný, ANS-poniklovaný	8,34	9,92	299,-

KĽUČKA NA EUROOKNO LATO-2 SO ZÁMKOM



povrch	Cena		
	bez DPH €	s DPH €	s DPH SK
F1, F2, F3, F4, F9	9,87	11,75	354,-
hnedá, biela	8,50	10,12	305,-

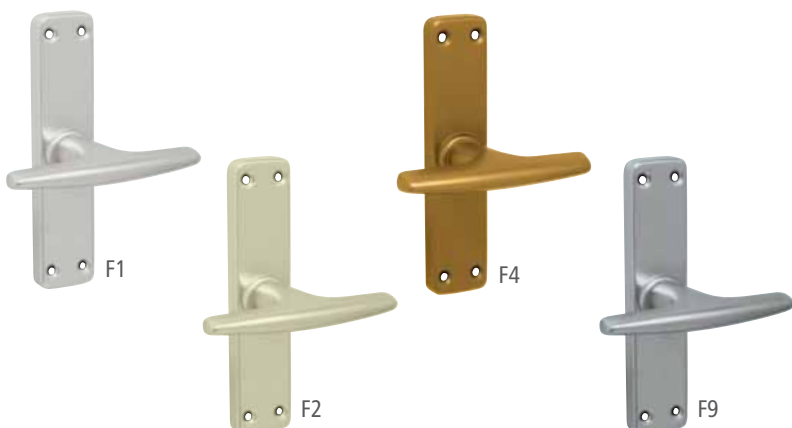

OKENNÁ OLIVA (ROZVORA)

povrch	Cena		
	bez DPH €	s DPH €	s DPH SK
F1, F2, F4	5,02	5,97	180,-
F9	5,52	6,57	198,-
Mechanizmus	1,70	2,02	61,-



kľučka na eurookno DK - LAURA 2



Italy Made in

povrchy	Cena		
	bez DPH €	s DPH €	s DPH SK
1. OLV - Mosadz leštená	10,40	12,38	373,-
2. OLS - Mosadz brúsená	10,40	12,38	373,-
3. OGS - Bronz čes. mat	10,40	12,38	373,-
4. OC - Chróm lesklý	11,38	13,54	408,-
5. OCS - Chróm brúsený	11,38	13,54	408,-
6. ONS - Nikel brúsený	11,38	13,54	408,-



kľučka na eurookno DK - PRELUDE 2



Italy Made in

povrchy	Cena		
	bez DPH €	s DPH €	s DPH SK
1. OLV - Mosadz leštená	10,40	12,38	373,-
2. OLS - Mosadz brúsená	10,40	12,38	373,-
3. OGS - Bronz čes. mat	10,40	12,38	373,-
4. OC - Chróm lesklý	12,75	15,17	457,-
5. OCS - Chróm brúsený	12,75	15,17	457,-
6. ONS - Nikel brúsený	12,75	15,17	457,-



kľučka na eurookno DK - GIADA



Italy Made in

povrchy	Cena		
	bez DPH €	s DPH €	s DPH SK
1. OLV - Mosadz leštená	10,40	12,38	373,-
2. OLS - Mosadz brúsená	10,40	12,38	373,-
3. OGS - Bronz čes. mat	10,40	12,38	373,-
4. OC - Chróm lesklý	12,75	15,17	457,-
5. OCS - Chróm brúsený	12,75	15,17	457,-
6. ONS - Nikel brúsený	12,75	15,17	457,-



kľučka na eurookno DK - CAST



Italy Made in

povrchy	Cena		
	bez DPH €	s DPH €	s DPH SK
1. OLV - Mosadz leštená	12,52	14,90	449,-
2. OLS - Mosadz brúsená	12,52	14,90	449,-
3. OGS - Bronz čes. mat	12,52	14,90	449,-
4. OC - Chróm lesklý	14,76	17,56	529,-
5. OCS - Chróm brúsený	14,76	17,56	529,-
6. ONS - Nikel brúsený	14,76	17,56	529,-



kľučka na eurookno

DK - FAN



Made in Italy

povrchy	Cena		
	bez DPH €	s DPH €	s DPH SK
1. OLV - Mosadz leštená	12,52	14,90	449,-
2. OLS - Mosadz brúsená	12,52	14,90	449,-
3. OGS - Bronz čes. mat	12,52	14,90	449,-
4. OC - Chróm lesklý	12,52	14,90	449,-
5. OCS - Chróm brúsený	12,52	14,90	449,-
6. ONS - Nikel brúsený	12,52	14,90	449,-



kľučka na eurookno

DK - ORION 2



Made in Italy

povrchy	Cena		
	bez DPH €	s DPH €	s DPH SK
1. OLV - Mosadz leštená	10,40	12,38	373,-
2. OLS - Mosadz brúsená	10,40	12,38	373,-
3. OGS - Bronz čes. mat	10,40	12,38	373,-
4. OC - Chróm lesklý	10,40	12,38	373,-
5. OCS - Chróm brúsený	10,40	12,38	373,-
6. ONS - Nikel brúsený	10,40	12,38	373,-



kľučka na eurookno

DK - DEA



Made in Italy

povrchy	Cena		
	bez DPH €	s DPH €	s DPH SK
1. OLV - Mosadz leštená	14,39	17,13	516,-
2. OLS - Mosadz brúsená	14,39	17,13	516,-
3. OGS - Bronz čes. mat	14,39	17,13	516,-
4. OC - Chróm lesklý	16,57	19,72	594,-
5. OCS - Chróm brúsený	16,57	19,72	594,-
6. ONS - Nikel brúsený	16,57	19,72	594,-

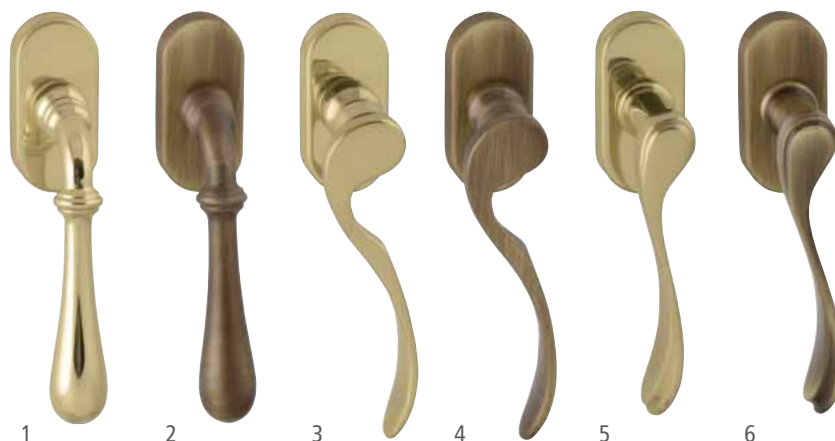

kľučka na eurookno

DK - CARINA, MILA, MILLY



Made in Italy

povrchy - CARINA	Cena		
	bez DPH €	s DPH €	s DPH SK
1. OLV - Mosadz leštená	14,39	17,13	516,-
2. OGS - Bronz čes. mat	15,12	17,99	542,-
povrchy - MILA			
3. OLV - Mosadz leštená	14,39	17,13	516,-
4. OGS - Bronz čes. mat	14,39	17,13	516,-
povrchy - MILLY			
5. OLV - Mosadz leštená	14,90	17,73	534,-
6. OGS - Bronz čes. mat	15,73	18,72	564,-



kľučka na eurookno
DK - ARTE



mariani

povrchy	Cena		
	bez DPH €	s DPH €	s DPH SK
1. OC - Chróm lesklý	38,50	45,81	1380,-
2. OCS - Chróm brúsený	38,50	45,81	1380,-
3. ONS - Nikel brúsený	39,89	47,47	1430,-
4. OGS - Bronz čes. mat	36,82	43,82	1320,-
5. PVD ZLATÁ	54,67	65,06	1960,-
6. PVD INOX	54,67	65,06	1960,-



kľučka na eurookno
DK - COMET



mariani

povrchy	Cena		
	bez DPH €	s DPH €	s DPH SK
1. OC - Chróm lesklý	33,45	39,80	1199,-
2. OCS - Chróm brúsený	33,45	39,80	1199,-
3. ONS - Nikel brúsený	34,73	41,33	1245,-
4. OC / OC / OCS	34,59	41,16	1240,-
5. ONL / ONL / ONS	35,71	42,49	1280,-



kľučka na eurookno
DK - COMET, SUN 1



mariani

povrchy COMET	Cena		
	bez DPH €	s DPH €	s DPH SK
1. OCS / OC / OCS	34,59	41,16	1240,-
2. ONS / ONL / ONS	35,71	42,49	1280,-
povrchy - SUN 1			
3. OCS / OC / OCS	35,98	42,82	1290,-
4. ONS / ONL / ONS	36,96	43,98	1325,-



kľučka na eurookno
DK - SUN 1



mariani

povrchy	Cena		
	bez DPH €	s DPH €	s DPH SK
1. OC - Chróm lesklý	34,73	41,33	1245,-
2. OCS - Chróm brúsený	34,73	41,33	1245,-
3. ONS - Nikel brúsený	35,98	42,82	1290,-
4. OC / OC / OCS	35,98	42,82	1290,-
5. ONL / ONL / ONS	36,96	43,98	1325,-

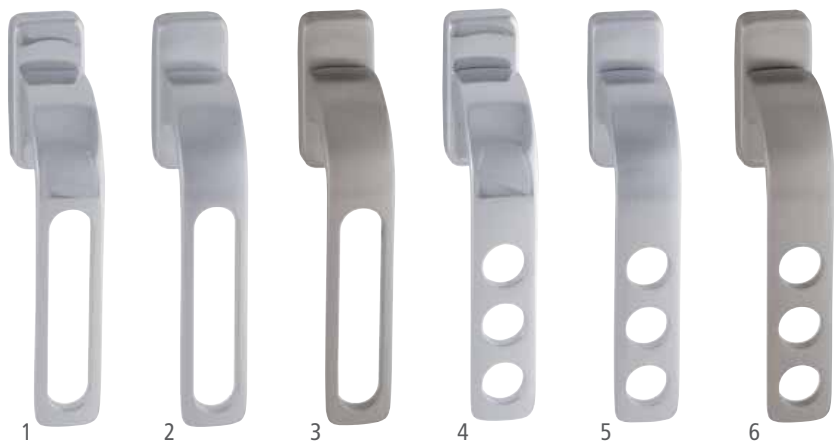

kľučka na eurookno DK - SUN 2, SUN 3

mariani

povrchy - SUN 2	Cena		
	bez DPH €	s DPH €	s DPH SK
1. OC - Chróm lesklý	35,71	42,49	1280,-
2. OCS - Chróm brúsený	35,71	42,49	1280,-
3. ONS - Nikel matný	37,38	44,48	1340,-
povrchy - SUN 3			
4. OC - Chróm lesklý	35,71	42,49	1280,-
5. OCS - Chróm brúsený	35,71	42,49	1280,-
6. ONS - Nikel brúsený	37,38	44,48	1340,-



kľučka na eurookno DK - CLOUD, ZENITH

mariani

povrchy - CLOUD	Cena		
	bez DPH €	s DPH €	s DPH SK
1. OC - Chróm lesklý	34,73	41,33	1245,-
2. OCS - Chróm brúsený	34,73	41,33	1245,-
3. ONS - Nikel matný	35,96	42,79	1289,-
povrchy - ZENITH			
4. OC - Chróm lesklý	32,08	38,17	1150,-
5. OCS - Chróm brúsený	32,08	38,17	1150,-
6. ONS - Nikel brúsený	32,92	39,17	1180,-



kľučka na eurookno DK - GOLF



mariani

povrchy	Cena		
	bez DPH €	s DPH €	s DPH SK
1. OC - Chróm lesklý	43,51	51,78	1560,-
2. OCS - Chróm brúsený	43,51	51,78	1560,-
3. ONS - Nikel brúsený	45,18	53,77	1620,-
4. OGS - Bronz čes. mat	41,56	49,46	1490,-

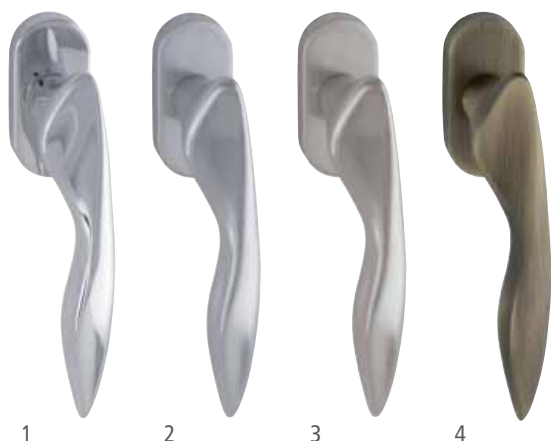

kľučka na eurookno DK - ZOE



mariani

povrchy	Cena		
	bez DPH €	s DPH €	s DPH SK
1. OC - Chróm lesklý	30,40	36,18	1090,-
2. OCS - Chróm brúsený	30,40	36,18	1090,-
3. ONS - Nikel brúsený	31,38	37,34	1125,-
4. OGS - Bronz čes. mat	27,87	33,16	999,-



kľučka na eurookno
DK - BURACO Q

TUPAI

	Cena		
	bez DPH €	s DPH €	s DPH SK
BURACO 1 HR 2737 Q			
1. VONS - Velvet nikel	27,65	32,90	991,-
2. OCS - Chróm brúsený	27,65	32,90	991,-
3. OC / BVOC - Chróm lesklý / čierny velvet chróm	27,65	32,90	991,-
BURACO 2 HR 2735 Q			
4. VONS - Velvet nikel	27,65	32,90	991,-
5. OCS - Chróm brúsený	27,65	32,90	991,-
6. OC / BVOC - Chróm lesklý / čierny velvet chróm	27,65	32,90	991,-



kľučka na eurookno
DK - LINHA Q

TUPAI

	Cena		
	bez DPH €	s DPH €	s DPH SK
LINHA 1 HR 2736 Q			
1. OCS - Chróm brúsený	27,65	32,90	991,-
2. OC / BVOC - Chróm lesklý / čierny velvet chróm	27,65	32,90	991,-
LINHA 2 HR 2730 Q			
3. OC - Chróm lesklý	27,65	32,90	991,-
4. OCS - Chróm brúsený	27,65	32,90	991,-
5. VONS - Velvet nikel	27,65	32,90	991,-
6. OGS - Bronz čes. mat	27,65	32,90	991,-



kľučka na eurookno
DK - CAIRO HR 2731 Q

TUPAI

	Cena		
povrchy	bez DPH €	s DPH €	s DPH SK
1. ONS - Nikel brúsený	24,21	28,81	868,-
2. OC - Chróm lesklý	24,21	28,81	868,-
3. OCS - Chróm brúsený	24,21	28,81	868,-
4. VONS - Velvet nikel	24,21	28,81	868,-
5. BVOC-Čierny vel. chróm	24,21	28,81	868,-
6. OC / BVOC - Chróm lesklý / čierny velvet chróm	24,21	28,81	868,-



kľučka na eurookno
DK - CINTO HR 2732 Q

TUPAI

	Cena		
povrchy	bez DPH €	s DPH €	s DPH SK
1. OGS - Bronz čes. mat.	27,65	32,90	991,-
2. OC - Chróm lesklý	27,65	32,90	991,-
3. OCS - Chróm brúsený	27,65	32,90	991,-
4. VONS - Velvet nikel	27,65	32,90	991,-
5. BVOC-Čierny vel. chróm	27,65	32,90	991,-
6. OC / BVOC - Chróm lesklý / čierny velvet chróm	27,65	32,90	991,-



kľučka na eurookno
DK - PRISMA, SQUARE

TUPAI

PRISMA HR 1921 Q	Cena		
	bez DPH €	s DPH €	s DPH SK
1. OC - Chróm lesklý	33,75	40,16	1210,-
2. OCS - Chróm brúsený	33,75	40,16	1210,-
3. VONS - Velvet nikel	34,67	41,26	1243,-
SQUARE HR 2275 Q			
4. OC - Chróm lesklý	25,69	30,57	921,-
5. OCS - Chróm brúsený	25,69	30,57	921,-
6. VONS - Velvet nikel	25,69	30,57	921,-

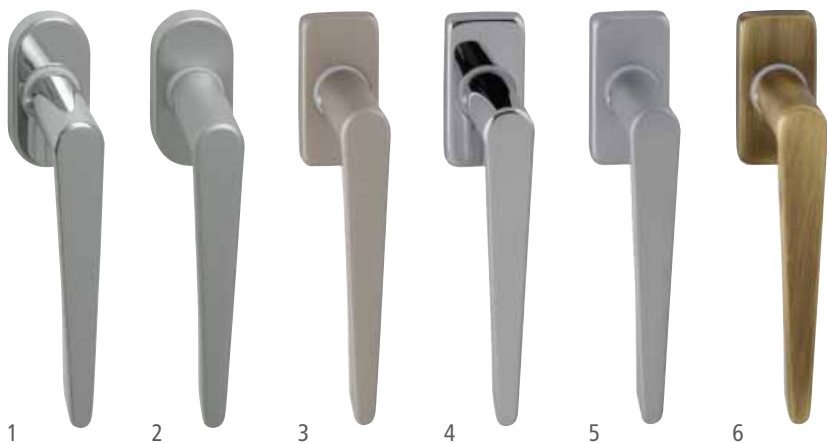

kľučka na eurookno
DK - SECO 1964

TUPAI

SECO 1964	Cena		
	bez DPH €	s DPH €	s DPH SK
1. OC - Chróm lesklý	19,58	23,30	702,-
2. VOC - Velvet chróm	19,58	23,30	702,-
SECO HR 1964 Q			
3. VONS - Velvet nikel	19,58	23,30	702,-
4. OC - Chróm lesklý	19,58	23,30	702,-
5. VOC - Velvet chróm	19,58	23,30	702,-
6. OGS - Bronz čes. mat	23,60	28,08	846,-



kľučka na eurookno
**DK - BREST, PRADO, DACAPO
DIAGO, META, MARENA**

TUPAI

povrch - N / OC / N nerez/chróm lesklý/nerez	Cena		
	bez DPH €	s DPH €	s DPH SK
1. BREST HR 2031/ A Q	23,15	27,55	830,-
2. PRADO HR 792 Q	18,66	22,21	669,-
3. DACAPO HR 791 Q	16,26	19,35	583,-
4. DIAGO HR 793 Q	20,97	24,96	752,-
5. META HR 795 Q	20,08	23,90	720,-
6. MARENA HR 794 Q	17,93	21,34	643,-

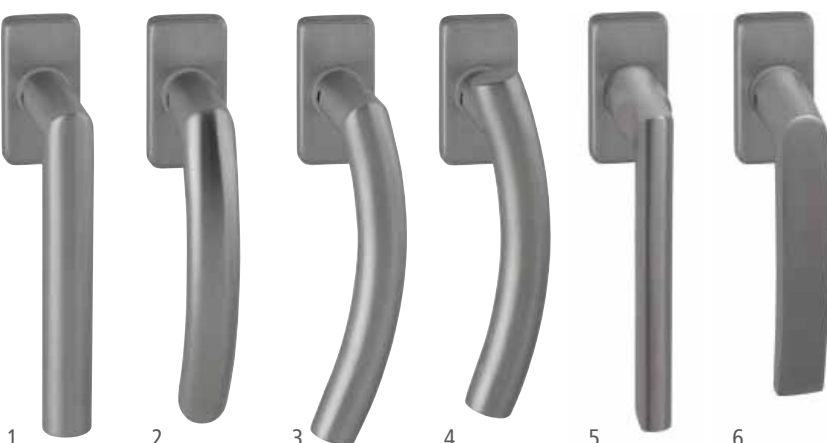

kľučka na eurookno
**DK - FAVORIT, NERO,
VEGA, DANIELA, LAGUNA**

TUPAI

povrch - N - Nerez (16)	Cena		
	bez DPH €	s DPH €	s DPH SK
1. FAVORIT HR 2002 Q	12,61	15,00	452,-
2. NERO HR 2233 Q	12,61	15,00	452,-
3. SWING HR 2232 Q	12,61	15,00	452,-
4. VEGA HR 2230 Q	12,61	15,00	452,-
5. DANIELA HR 2253 Q	24,49	29,14	878,-
6. LAGUNA HR 2254 Q	24,49	29,14	878,-

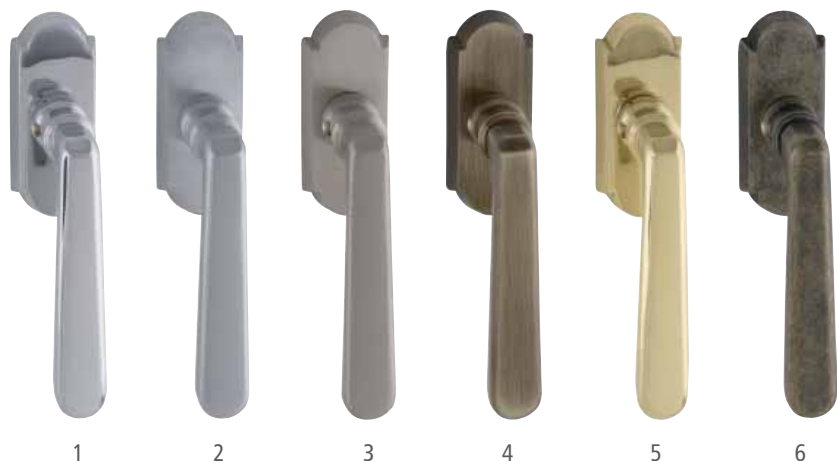

kľučka na eurookno DK - ALT - WIEN

Made in Italy

povrchy	Cena		
	bez DPH €	s DPH €	s DPH SK
1. OC - Chróm lesklý	15,01	17,86	538,-
2. OCS - Chróm brúsený	15,01	17,86	538,-
3. ONS - Nikel brúsený	15,01	17,86	538,-
4. OGR - Bronz česaný	12,50	14,87	448,-
5. OLV - Mosadz leštená	12,50	14,87	448,-
6. OBA - Antik bronz	12,50	14,87	448,-

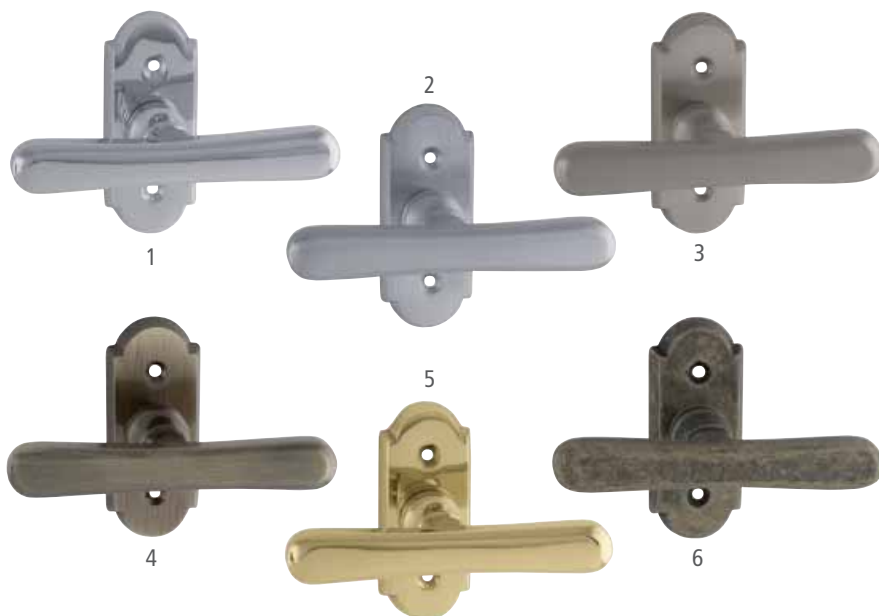

oliva (štít 80x32) ALT - WIEN

Made in Italy

povrchy	Cena		
	bez DPH €	s DPH €	s DPH SK
1. OC - Chróm lesklý	11,74	13,97	421,-
2. OCS - Chróm brúsený	11,74	13,97	421,-
3. ONS - Nikel brúsený	11,74	13,97	421,-
4. OGR - Bronz česaný	9,98	11,88	358,-
5. OLV - Mosadz leštená	9,98	11,88	358,-
6. OBA - Antik bronz	9,98	11,88	358,-

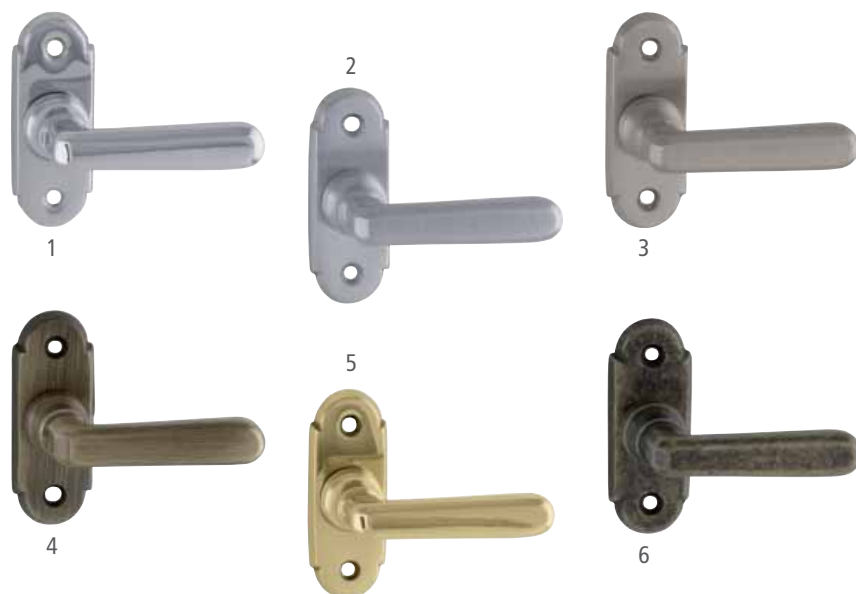

pololiva malá 1 (štít 63x24) ALT - WIEN

Made in Italy

povrchy	Cena		
	bez DPH €	s DPH €	s DPH SK
1. OC - Chróm lesklý	10,27	12,22	368,-
2. OCS - Chróm brúsený	10,27	12,22	368,-
3. ONS - Nikel brúsený	10,27	12,22	368,-
4. OGR - Bronz česaný	9,01	10,72	323,-
5. OLV - Mosadz leštená	9,01	10,72	323,-
6. OBA - Antik bronz	9,01	10,72	323,-

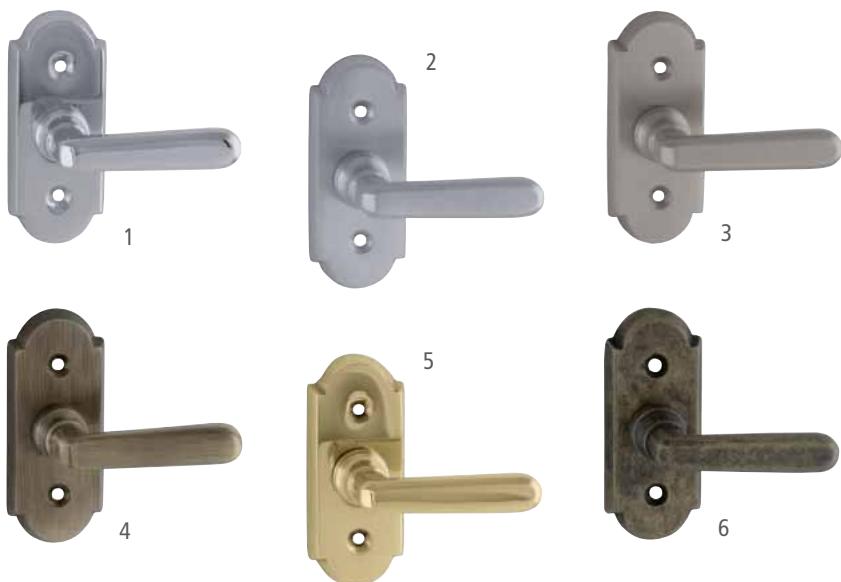

pololiva malá 2 (štít 80x32)
ALT - WIEN

Made in Italy

povrchy	Cena		
	bez DPH €	s DPH €	s DPH SK
1. OC - Chróm lesklý	10,51	12,51	377,-
2. OCS - Chróm brúsený	10,51	12,51	377,-
3. ONS - Nikel brúsený	10,51	12,51	377,-
4. OGR - Bronz česaný	9,26	11,02	332,-
5. OLV - Mosadz leštená	9,26	11,02	332,-
6. OBA - Antik bronz	9,26	11,02	332,-



pololiva veľká (štít 80x32)
ALT - WIEN

Made in Italy

povrchy	Cena		
	bez DPH €	s DPH €	s DPH SK
1. OC - Chróm lesklý	11,99	14,27	430,-
2. OCS - Chróm brúsený	11,99	14,27	430,-
3. ONS - Nikel brúsený	11,99	14,27	430,-
4. OGR - Bronz česaný	10,51	12,51	377,-
5. OLV - Mosadz leštená	10,51	12,51	377,-
6. OBA - Antik bronz	10,51	12,51	377,-

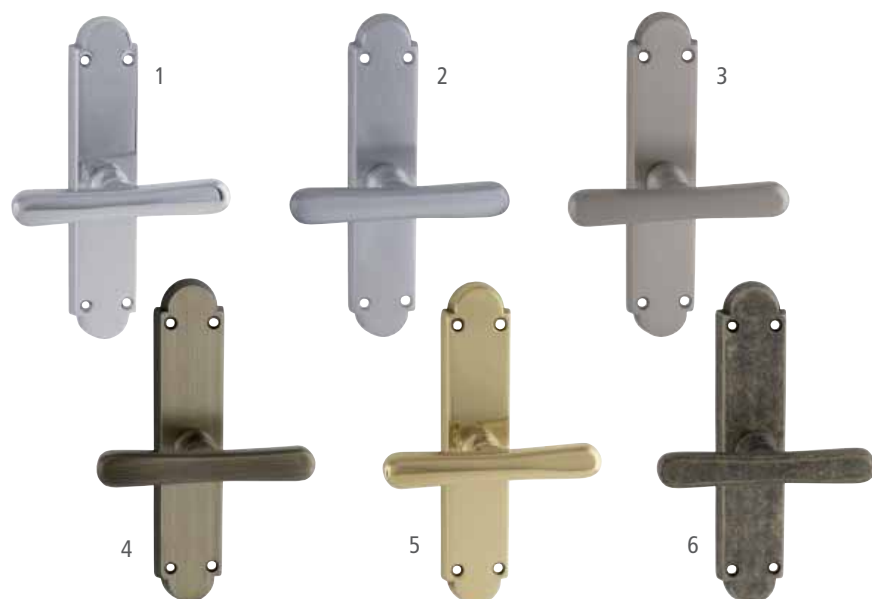

rozvora (štít 170x35)
ALT - WIEN

Made in Italy

povrchy	Cena		
	bez DPH €	s DPH €	s DPH SK
1. OC - Chróm lesklý	15,01	17,86	538,-
2. OCS - Chróm brúsený	15,01	17,86	538,-
3. ONS - Nikel brúsený	15,01	17,86	538,-
4. OGR - Bronz česaný	12,50	14,87	448,-
5. OLV - Mosadz leštená	12,50	14,87	448,-
6. OBA - Antik bronz	12,50	14,87	448,-



kľučka na eurookno DK - ELEGANT

Made in Italy

povrchy	Cena		
	bez DPH €	s DPH €	s DPH SK
1. OC - Chróm lesklý	12,50	14,87	448,-
2. OCS - Chróm brúsený	12,50	14,87	448,-
3. ONS - Nikel brúsený	12,50	14,87	448,-
4. OGR - Bronz česaný	9,98	11,88	358,-
5. OLV - Mosadz leštená	9,98	11,88	358,-

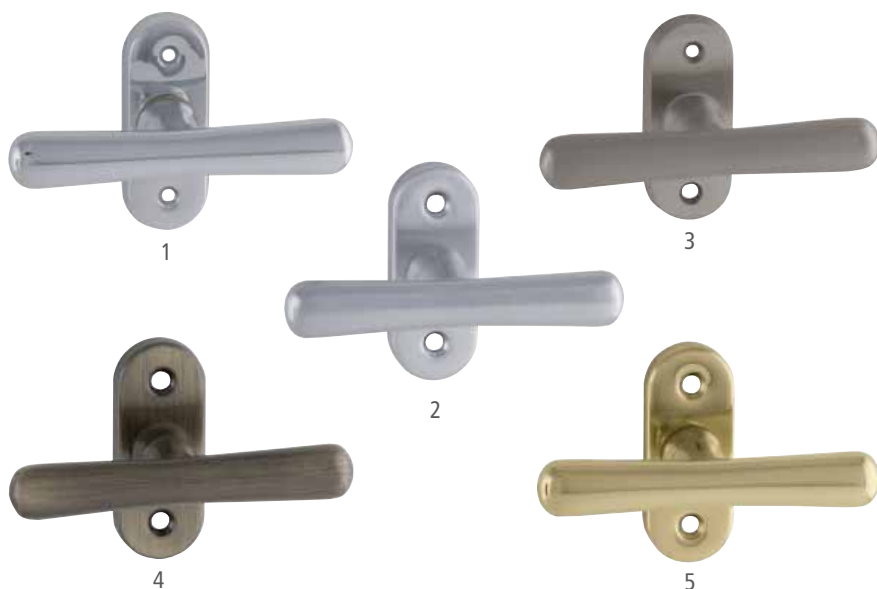

oliva (štít 67x28) ELEGANT

Made in Italy

povrchy	Cena		
	bez DPH €	s DPH €	s DPH SK
1. OC - Chróm lesklý	9,98	11,88	358,-
2. OCS - Chróm brúsený	9,98	11,88	358,-
3. ONS - Nikel brúsený	9,98	11,88	358,-
4. OGR - Bronz česaný	8,26	9,83	296,-
5. OLV - Mosadz leštená	8,26	9,83	296,-



pololiva malá (štít 67x28) ELEGANT

Made in Italy

povrchy	Cena		
	bez DPH €	s DPH €	s DPH SK
1. OC - Chróm lesklý	9,51	11,32	341,-
2. OCS - Chróm brúsený	9,51	11,32	341,-
3. ONS - Nikel brúsený	9,51	11,32	341,-
4. OGR - Bronz česaný	7,76	9,23	278,-
5. OLV - Mosadz leštená	7,76	9,23	278,-



pololiva veľká (štít 67x28)
ELEGANT

Made in Italy

povrchy	Cena		
	bez DPH €	s DPH €	s DPH SK
1. OC - Chróm lesklý	9,98	11,88	358,-
2. OCS - Chróm brúsený	9,98	11,88	358,-
3. ONS - Nikel brúsený	9,98	11,88	358,-
4. OGR - Bronz česaný	9,26	11,02	332,-
5. OLV - Mosadz leštená	9,26	11,02	332,-

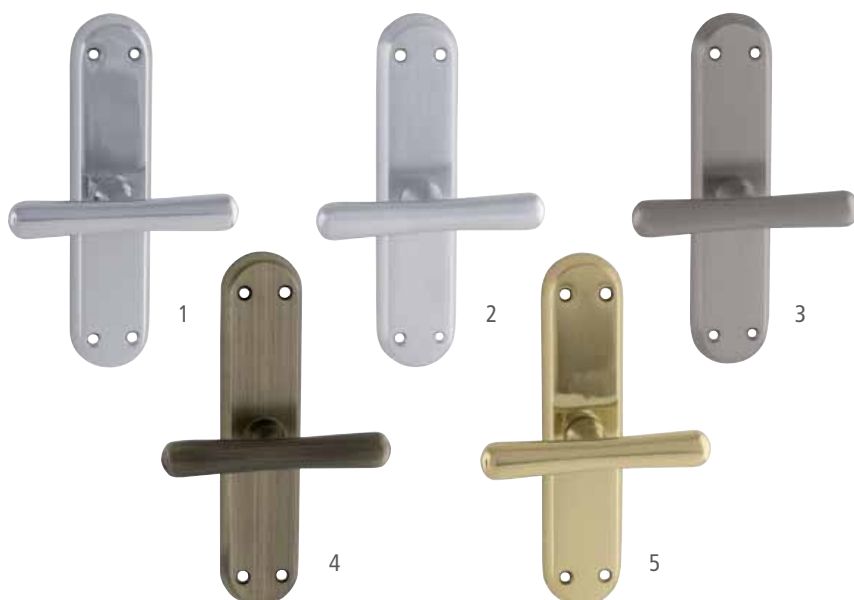

rozvora (štít 162x37)
ELEGANT

Made in Italy

povrchy	Cena		
	bez DPH €	s DPH €	s DPH SK
1. OC - Chróm lesklý	12,50	14,87	448,-
2. OCS - Chróm brúsený	12,50	14,87	448,-
3. ONS - Nikel brúsený	12,50	14,87	448,-
4. OGR - Bronz česaný	9,98	11,88	358,-
5. OLV - Mosadz leštená	9,98	11,88	358,-



1



2



3



4



5



6

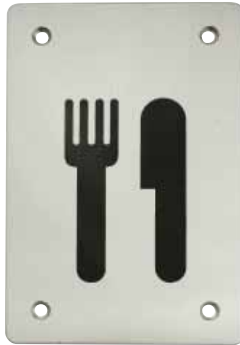

7



8



9



10



11



12

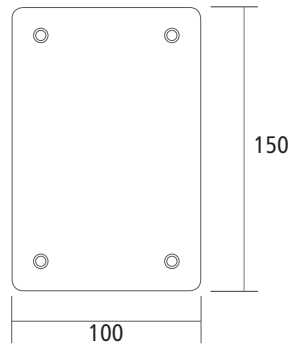

100

150

NEREZOVÉ PIKTOGRAMY

TUPAI

vyobrazenie:	Cena		
	bez DPH €	s DPH €	s DPH SK
1. dámy	7,92	9,43	284,-
2. páni	7,92	9,43	284,-
3. prvá pomoc	7,92	9,43	284,-
4. zákaz telefonovania	7,92	9,43	284,-
5. telesne postihnutí	7,92	9,43	284,-
6. zákaz fajčiť	7,92	9,43	284,-
7. reštauračné priestory	7,92	9,43	284,-
8. WC	7,92	9,43	284,-
9. šatňa	7,92	9,43	284,-
10. zákaz vodenia psov	7,92	9,43	284,-
11. šípka	7,92	9,43	284,-
12. fajčiarske priestory	7,92	9,43	284,-
kaviareň	7,92	9,43	284,-
prebalovací pult	7,92	9,43	284,-
telefón	7,92	9,43	284,-
13. dámy	4,18	4,98	150,-
14. páni	4,18	4,98	150,-
15. telesne postihnutí	4,18	4,98	150,-
16. zákaz fajčiť	4,18	4,98	150,-
17. panáčik - dámy	8,12	9,66	291,-
18. panáčik - páni	8,12	9,66	291,-



13



14



15



16

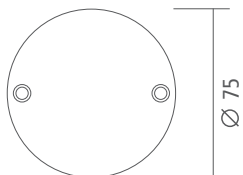

Ø 75



17



18

ČÍSLICA NEREZ 160 mm

0 1 2 3 4 5 6 7 8 9
A a B b C c

VELKÉ malé VELKÉ malé VELKÉ malé

Popis:	Cena		
	bez DPH €	s DPH €	s DPH SK
0, 1, 2, 3, 4, 5, 6, 7, 8, 9, a, b, c	13,92	16,56	499,-

ČÍSLICA NEREZ 270 120 mm

0 1 2 3 4
5 6 7 8 9

TUPAI

Popis:	Cena		
	bez DPH €	s DPH €	s DPH SK
0, 1, 2, 3, 4, 5, 6, 7, 8, 9	8,34	9,92	299,-

ČÍSLICA NEREZ 2.50 120 mm

0 1 2 3 4 5 6
7 8 9 a b c

Popis:	Cena		
	bez DPH €	s DPH €	s DPH SK
0, 1, 2, 3, 4, 5, 6, 7, 8, 9, a, b, c	10,57	12,58	379,-

ČÍSLICA KOVANÉ ŽELEZO 120 mm

povrch | Sivočierna

0 1 2 3 4 5 6
7 8 9 a b c d

Popis:	Cena		
	bez DPH €	s DPH €	s DPH SK
0, 1, 2, 3, 4, 5, 6, 7, 8, 9, a, b, c, d ...	5,02	5,97	180,-

ČÍSLICA BRONZ 120 mm

0 1 2 3 4
5 6 7 8 9
a b c

Popis:	Cena		
	bez DPH €	s DPH €	s DPH SK
0, 1, 2, 3, 4, 5, 6, 7, 8, 9, a, b, c	5,44	6,47	195,-

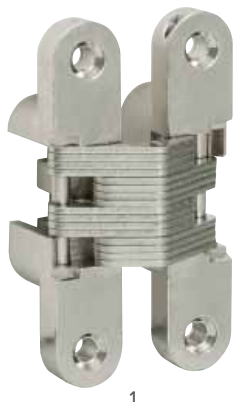

1

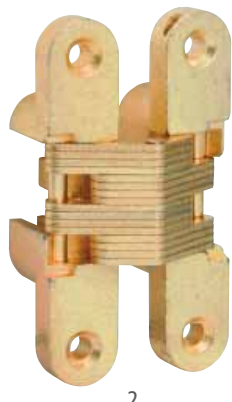

2



3

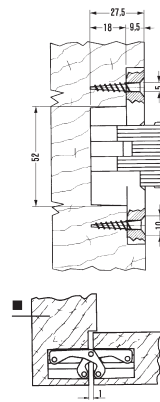
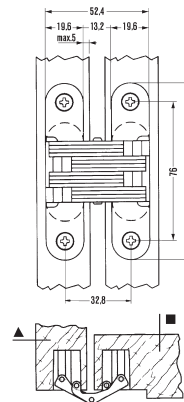

5



6

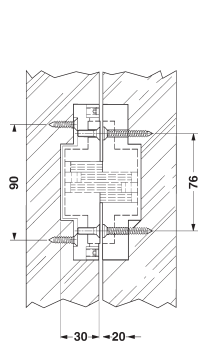
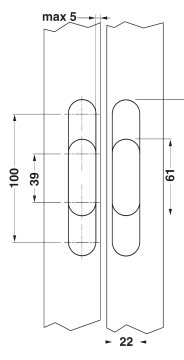

7

25 mm

89 mm

SKRYTÉ ZÁVESY NA BEZFALCOVÉ DVERE

kód	názov	povrch	nosnosť v kg		Cena		
			2 ks	3 ks	bez DPH €	s DPH €	s DPH SK
1	830 záves	ponikovaný	40	60	16,93	20,15	607,-
2	830 záves	pomosadený	40	60	16,93	20,15	607,-
3	830 záves	pobronzovaný	40	60	16,93	20,15	607,-
4	800 3D podložka	ponikovaný	40	60	11,69	13,91	419,-
5	800 3D podložka	pomosadený	40	60	11,69	13,91	419,-
6	800 3D podložka	pobronzovaný	40	60	11,69	13,91	419,-
7	2010 záves	nerez	40	60	8,26	9,83	296,-

KOVANIA NA POSUVNÉ DVERE DO 60 KG

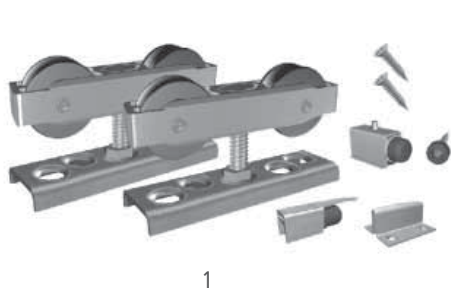

1

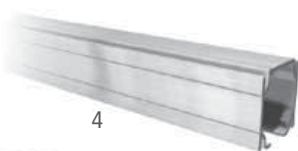

4



3

2

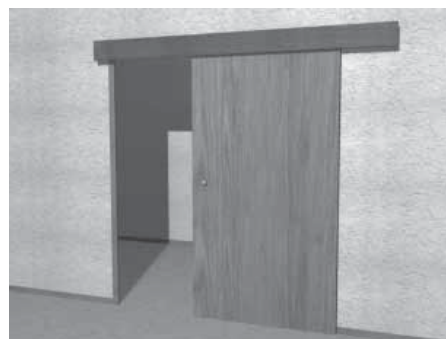

Cena
bez DPH € s DPH € s DPH SK

1. sada príslušenstva SF A60	26,44	31,47	948,-
2. upínací element na profil	1,14	1,36	41,-
3. držiak krycej dosky	3,68	4,38	132,-

Cena
bez DPH € s DPH € s DPH SK

4. profil ku kovaniu SF A60 2m	22,15	26,36	794,-
4. profil ku kovaniu SF A60 3m	33,17	39,47	1189,-

ZÁVESY NA DVERE

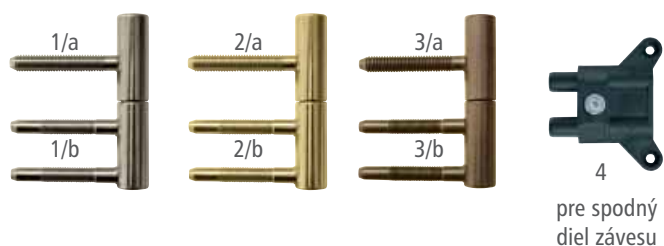

popis	kód	povrch	bal.	Cena		
				bez DPH €	s DPH €	s DPH SK
1/a Vrchný diel	100	nikel	300	0,40	0,48	14,50
1/b Spodný diel	100	nikel	200	0,76	0,91	27,50
2/a Vrchný diel	100	mosadz	300	0,43	0,51	15,50
2/b Spodný diel	100	mosadz	200	0,76	0,91	27,50
3/a Vrchný diel	100	bronz	300	0,46	0,55	16,50
3/b Spodný diel	100	bronz	200	0,84	1,00	30,-
4 Plastový držiak závesu	JR 519		200	0,84	1,00	30,-

ZÁVESY NA DVERE NASTAVITEĽNÉ

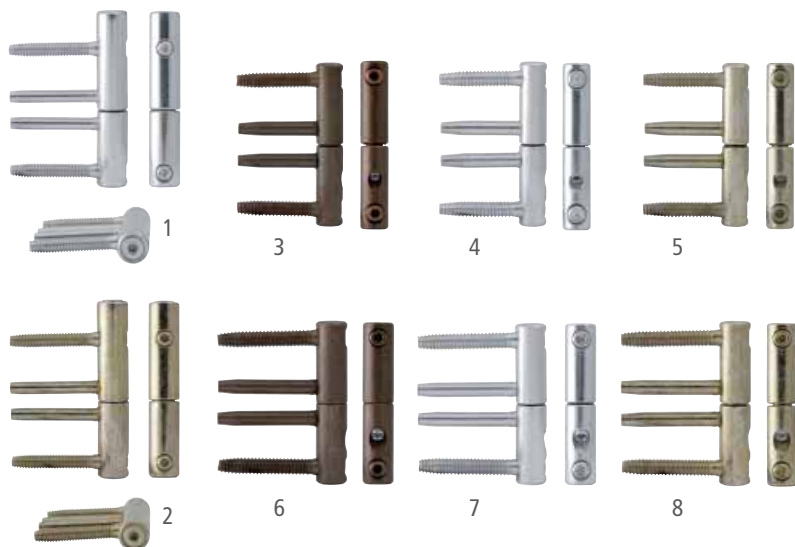

AGB

	Cena		
	bez DPH €	s DPH €	s DPH SK
1. Ø 20 - Strieborný pozink	8,79	10,46	315,-
2. Ø 20 - Žltý pozink	8,79	10,46	315,-
3. Ø 14 - Bronz matný	3,91	4,65	140,-
4. Ø 14 - Strieborný pozink	3,60	4,28	129,-
5. Ø 14 - Žltý pozink	3,82	4,55	137,-
6. Ø 16 - Bronz matný	4,82	5,74	173,-
7. Ø 16 - Strieborný pozink	4,02	4,78	144,-
8. Ø 16 - Žltý pozink	4,02	4,78	144,-

ZÁSTRČ F16

AGB

povrchy	Cena		
	bez DPH €	s DPH €	s DPH SK
1. H150 mm Bronz matný	2,01	2,39	72,-
2. H150 mm Žltý pozink	2,01	2,39	72,-
3. H150 mm Nikel lesklý	2,01	2,39	72,-
4. H150 mm Mosadz lesklá	2,01	2,39	72,-
5. H150 mm Velvet chróm	2,01	2,39	72,-
6. H150 mm Biely pozink	2,01	2,39	72,-
7. H250 mm Bronz matný	2,24	2,66	80,-
8. H250 mm Žltý pozink	2,24	2,66	80,-
9. H250 mm Nikel lesklý	2,24	2,66	80,-
10. H250 mm Mosadz lesklá	2,24	2,66	80,-
11. H250 mm Velvet chróm	2,24	2,66	80,-



KRYTKA NA ZÁVES

AGB

	Cena / ks		
	bez DPH €	s DPH €	s DPH SK
1. KRYTKA NA ZÁVES Ø20 všetky povrchy	2,09	2,49	75,-
2. KRYTKA NA ZÁVES Ø16 všetky povrchy	1,00	1,19	36,-
3. KRYTKA NA ZÁVES Ø14 všetky povrchy	0,95	1,13	34,-



záмок na dvere

ZÁMOK F18 - WC zámok



1 2 3 4 5 6

AGB

povrchy	Cena		
	bez DPH €	s DPH €	s DPH SK
1. Bronz matný	5,22	6,21	187,-
2. Žltý pozink	4,71	5,61	169,-
3. Nikel lesklý	5,33	6,34	191,-
4. Mosadz lesklá	6,25	7,44	224,-
5. Velvet chróm	7,14	8,50	256,-
6. Biely pozink	4,94	5,88	177,-

záмок na dvere

ZÁMOK F18 - BB



1 2 3 4 5 6

AGB

povrchy	Cena		
	bez DPH €	s DPH €	s DPH SK
1. Bronz tmavý	4,61	5,48	165,-
2. Žltý pozink	4,13	4,91	148,-
3. Nikel lesklý	4,71	5,61	169,-
4. Mosadz leštená	5,83	6,94	209,-
5. Velvet chróm	6,53	7,77	234,-
6. Biely pozink	4,38	5,21	157,-

záмок na dvere

ZÁMOK F18 - PZ



1 2 3 4 5 6

AGB

povrchy	Cena		
	bez DPH €	s DPH €	s DPH SK
1. Bronz tmavý	5,75	6,84	206,-
2. Žltý pozink	5,22	6,21	187,-
3. Nikel lesklý	5,88	7,00	211,-
4. Mosadz leštená	6,97	8,30	250,-
5. Velvet chróm	7,70	9,16	276,-
6. Biely pozink	6,05	7,20	217,-

Rozteč 90 mm, zádlab 75 mm, dormas 50 mm, čelo zámku 238 x 18 mm - platí pre všetky zámky na dvere.

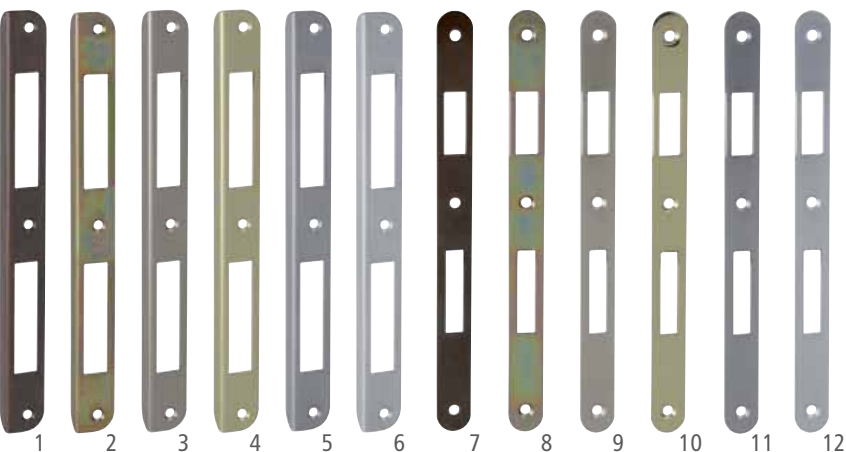

zámok na posuvné dvere GAN F22 - WC zámok

Protiplechy k zámkom na posuvné dvere sa nachádzajú v balení a sú zahrnuté v cene.

AGB

povrchy	Cena		
	bez DPH €	s DPH €	s DPH SK
1. Bronz matný	9,54	11,35	342,-
2. Nikel lesklý	12,72	15,14	456,-
3. Mosadz lesklá	10,15	12,08	364,-
4. Velvet chróm	12,61	15,00	452,-

zámok na posuvné dvere GAN F22 - BB

Protiplechy k zámkom na posuvné dvere sa nachádzajú v balení a sú zahrnuté v cene.

AGB

povrchy	Cena		
	bez DPH €	s DPH €	s DPH SK
1. Bronz matný	9,82	11,68	352,-
2. Nikel lesklý	13,08	15,57	469,-
3. Mosadz lesklá	10,15	12,08	364,-
4. Velvet chróm	12,81	15,24	459,-

zámok na posuvné dvere GAN F22 - PZ

Protiplechy k zámkom na posuvné dvere sa nachádzajú v balení a sú zahrnuté v cene.

AGB

povrchy	Cena		
	bez DPH €	s DPH €	s DPH SK
1. Bronz matný	9,82	11,68	352,-
2. Nikel lesklý	11,71	13,94	420,-
3. Mosadz lesklá	10,43	12,41	374,-
4. Velvet chróm	13,08	15,57	469,-

AGB

PROTIPLECH

povrchy	Cena		
	bez DPH €	s DPH €	s DPH SK
1. F18 Bronz matný	0,61	0,73	22,-
2. F18 Žltý pozink	0,61	0,73	22,-
3. F18 Nikel leklý	0,89	1,06	32,-
4. F18 Mosadz lesklá	0,81	0,96	29,-
5. F18 Velvet chróm	1,42	1,69	51,-
6. F18 Biely pozink	0,64	0,76	23,-
7. F20 Bronz matný	0,50	0,60	18,-
8. F20 Žltý pozink	0,59	0,70	21,-
9. F20 Nikel lesklý	0,84	1,00	30,-
10. F20 Mosadz lesklá	0,76	0,90	27,-
11. F20 Velvet chróm	1,37	1,63	49,-
12. F20 Biely pozink	0,59	0,70	21,-

MADIELKO DO ČELA POSUVNÝCH DVERÍ

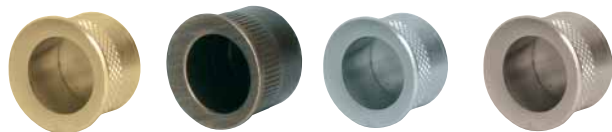

Made in Italy

priemer 29 mm	Cena		
	bez DPH €	s DPH €	s DPH SK
OLV - Mosadz leštená	2,98	3,55	107,-
OGR - Bronz česaný	2,98	3,55	107,-
OC - Chróm lesklý	3,29	3,92	118,-
OCS - Chróm brúsený	3,29	3,92	118,-
ONS - Nikel matný	3,82	4,55	137,-

MUŠĽA NA POSUVNÉ DVERE OVÁL



125 x 39 mm	Cena		
	bez DPH €	s DPH €	s DPH SK
1. OC - Chróm lesklý	7,50	8,93	269,-
2. OCS - Chróm brúsený	7,50	8,93	269,-
3. ONS - Nikel matný	7,50	8,93	269,-
4. OGR - Bronz česaný	5,83	6,94	209,-
5. OLV - Mosadz leštená	5,83	6,94	209,-

MUŠĽA NA POSUVNÉ DVERE



Made in Italy

	rozмеры v mm	Cena		
		bez DPH €	s DPH €	s DPH SK
1. F1 - Prírodný elox	40 x 120	4,46	5,31	160,-
2. F4 - Bronz elox	40 x 120	4,46	5,31	160,-
3. Nerez ovál	40 x 120	7,78	9,26	279,-
4. Nerez hranatá 1696	50 x 100	13,83	16,46	496,-
5. Kované železo	50 x 128	8,14	9,69	292,-

HLINÍKOVÉ MADIELKO 70x25



Made in Italy

	Cena		
	bez DPH €	s DPH €	s DPH SK
1. F1-Prírodný elox	2,39	2,85	86,-
2. F2-Šampaňo elox	2,39	2,85	86,-
3. F4-Bronz elox	2,39	2,85	86,-
4. F9-Nerez elox	2,39	2,85	86,-
5. B-Biely	2,39	2,85	86,-

MUŠĽA HRANATÁ MALÁ 2649



TUPAI

55 x 82 mm	Cena		
	bez DPH €	s DPH €	s DPH SK
1. OC - Chróm lesklý	9,73	11,58	349,-
2. OCS - Chróm brúsený	9,73	11,58	349,-
3. ONS - Nikel matný	9,73	11,58	349,-
4. VONS - Velvet nikel	9,73	11,58	349,-
5. OGS - Bronz česaný	9,73	11,58	349,-
6. BVOC - Čierny nikel	9,73	11,58	349,-

Uvedené ceny sú za 1 ks.

MUŠĽA HRANATÁ VEĽKÁ 2650



TUPAI

55 x 115 mm	Cena		
	bez DPH €	s DPH €	s DPH SK
1. OC - Chróm lesklý	12,52	14,90	449,-
2. OCS - Chróm brúsený	12,52	14,90	449,-
3. ONS - Nikel matný	12,52	14,90	449,-
4. VONS - Velvet nikel	12,52	14,90	449,-
5. OGS - Bronz česaný	12,52	14,90	449,-
6. BVOC - Čierny nikel	12,52	14,90	449,-

Uvedené ceny sú za 1 ks.

MUŠĽA HRANATÁ UNO



1 2 3 4 5

mariani

75 x 60 mm	Cena		
	bez DPH €	s DPH €	s DPH SK
1. OC - Chróm lesklý, pár	43,40	51,65	1556,-
2. OCS - Chróm brúsený, pár	43,40	51,65	1556,-
3. ONS - Nikel matný, pár	44,69	53,18	1602,-
4. OGS - Bronz česaný, pár	41,50	49,39	1488,-
5. OLV - Mosadz leštená, pár	41,50	49,39	1488,-

MUŠĽA HRANATÁ UNO - WC



1 2 3 4 5

mariani

75 x 60 mm	Cena		
	bez DPH €	s DPH €	s DPH SK
1. OC - Chróm lesklý, pár	54,84	65,26	1966,-
2. OCS - Chróm brúsený, pár	54,84	65,26	1966,-
3. ONS - Nikel matný, pár	56,51	67,25	2026,-
4. OGS - Bronz česaný, pár	52,30	62,24	1875,-
5. OLV - Mosadz leštená, pár	52,30	62,24	1875,-

MUŠĽA OVÁLNÁ DUE



1 2 3 4 5

mariani

84 x 60 mm	Cena		
	bez DPH €	s DPH €	s DPH SK
1. OC - Chróm lesklý, pár	43,40	51,65	1556,-
2. OCS - Chróm brúsený, pár	43,40	51,65	1556,-
3. ONS - Nikel matný, pár	44,69	53,18	1602,-
4. OGS - Bronz česaný, pár	41,50	49,39	1488,-
5. OLV - Mosadz leštená, pár	41,50	49,39	1488,-

MUŠĽA OVÁLNÁ DUE - WC



1 2 3 4 5

mariani

84 x 60 mm	Cena		
	bez DPH €	s DPH €	s DPH SK
1. OC - Chróm lesklý, pár	54,84	65,26	1966,-
2. OCS - Chróm brúsený, pár	54,84	65,26	1966,-
3. ONS - Nikel matný, pár	56,51	67,25	2026,-
4. OGS - Bronz česaný, pár	52,30	62,24	1875,-
5. OLV - Mosadz leštená, pár	52,30	62,24	1875,-

MUŠĽA OZDOBNÁ TRE

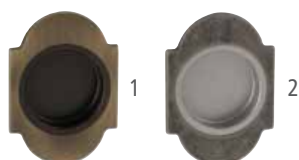

mariani

84 x 60 mm	Cena		
	bez DPH €	s DPH €	s DPH SK
1. OGS - Bronz česaný, pár	41,50	49,39	1488,-
2. BAN - Čierny antik, pár	41,50	49,39	1487,-

MUŠĽA OZDOBNÁ TRE - WC

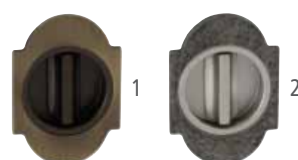

mariani

84 x 60 mm	Cena		
	bez DPH €	s DPH €	s DPH SK
1. OGS - Bronz česaný, pár	52,30	62,24	1875,-
2. BAN - Čierny antik, pár	52,30	62,24	1875,-

KLOPADLO VICTORIAN VELKÉ 195 x 100 mm

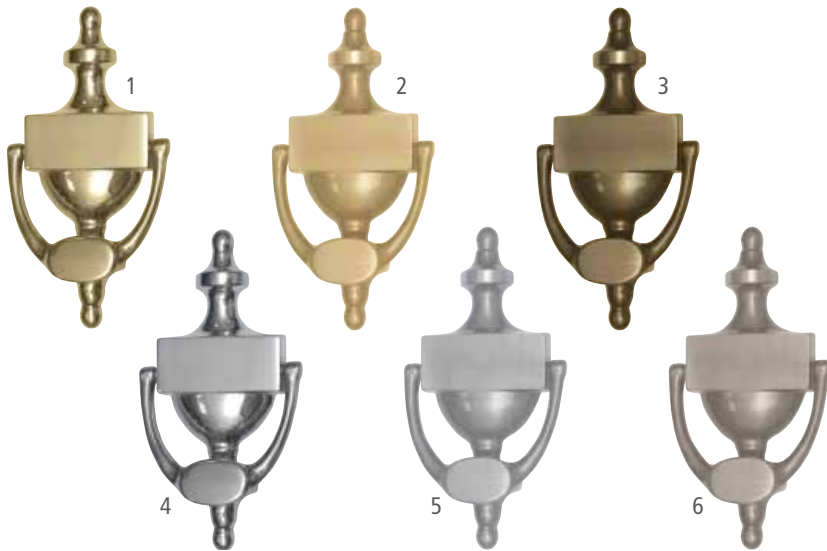

Made in Italy

povrch	Cena		
	bez DPH €	s DPH €	s DPH SK
1. OLV - Mosadz leštená	13,75	16,36	493,-
2. OLS - Mosadz brúsená	13,75	16,36	493,-
3. OGS - Bronz česaný mat	14,50	17,26	520,-
4. OC - Chróm lesklý	16,87	20,08	605,-
5. OCS - Chróm brúsený	16,87	20,08	605,-
6. ONS - Nikel brúsený	17,27	20,55	619,-

KLOPADLO VICTORIAN MALÉ 154 x 75 mm

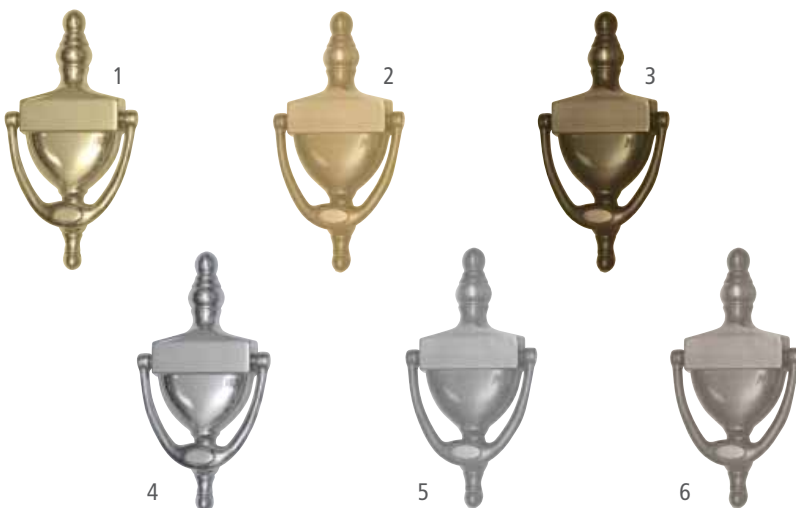

Made in Italy

povrch	Cena		
	bez DPH €	s DPH €	s DPH SK
1. OLV - Mosadz leštená	10,76	12,81	386,-
2. OLS - Mosadz brúsená	10,76	12,81	386,-
3. OGS - Bronz česaný mat	11,38	13,54	408,-
4. OC - Chróm lesklý	13,89	16,53	498,-
5. OCS - Chróm brúsený	13,89	16,53	498,-
6. ONS - Nikel brúsený	14,25	16,96	511,-

KLOPADLO GEORGIAN VELKÉ 175 x 100 mm



Made in Italy

povrch	Cena		
	bez DPH €	s DPH €	s DPH SK
1. OLV - Mosadz leštená	15,01	17,86	538,-
2. OGS - Bronz česaný mat	15,76	18,75	565,-

RETIAZKA NA DVERE 650

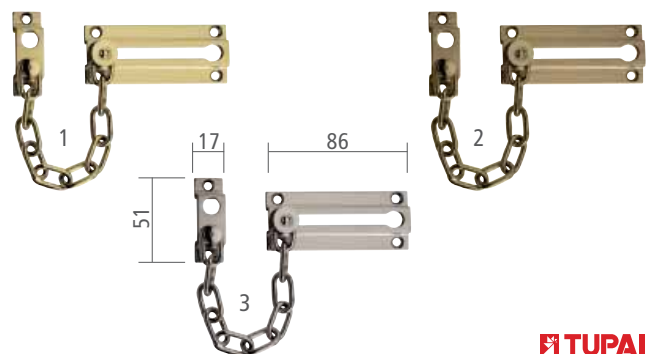

TUPAI

povrch	kód	Cena		
		bez DPH €	s DPH €	s DPH SK
1. Mosadz	650	11,02	13,11	395,-
2. Bronz	650	13,22	15,73	474,-
3. Nikel	650	14,31	17,03	513,-



ZARÁŽKA DVERÍ POLKOPULKA



povrchy	rozmer	Cena		
		bez DPH €	s DPH €	s DPH SK
1. OLV - Mosadz leštená	45 x 29 mm	3,29	3,92	118,-
2. OGR - Bronz česaný	45 x 29 mm	3,29	3,92	118,-
3. OC - Chróm lesklý	45 x 29 mm	4,33	5,15	155,-
4. OCS - Chróm brúsený	45 x 29 mm	4,33	5,15	155,-
5. ONS - Nikel matný	45 x 29 mm	4,33	5,15	155,-

ZARÁŽKA DVERÍ NA PODLAHU VALČEK



Made in Italy

povrchy	rozmer	Cena		
		bez DPH €	s DPH €	s DPH SK
1. OLV - Mosadz leštená	45 x 28 mm	4,34	5,16	155,-
2. OGR - Bronz česaný	45 x 28 mm	4,34	5,16	155,-
3. OC - Chróm lesklý	45 x 28 mm	4,34	5,16	155,-
4. OCS - Chróm brúsený	45 x 28 mm	4,34	5,16	155,-
5. ONS - Nikel matný	45 x 28 mm	4,34	5,16	155,-

ZARÁŽKA DVERÍ HRANATÁ NEREZ

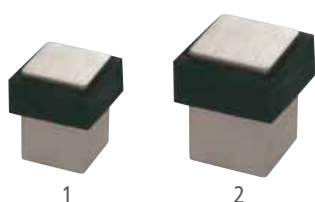

TUPAI

povrchy	kód	rozмеры	Cena		
			bez DPH €	s DPH €	s DPH SK
1. N - Nerez masív	2060	22 x 30 mm	7,31	8,70	262,-
2. N - Nerez masív	2261	28 x 44 mm	9,93	11,82	356,-

ZARÁŽKA DVERÍ NA PODLAHU

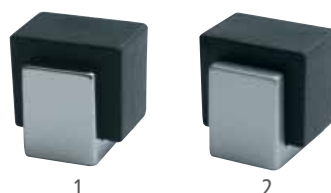

povrchy	rozmer	Cena		
		bez DPH €	s DPH €	s DPH SK
1. OC - Chróm lesklý	30x30x30 mm	9,49	11,29	340,-
2. OCS - Chróm brúsený	30x30x30 mm	9,49	11,29	340,-

ZARÁŽKA DVERÍ NA STENU



TUPAI

povrchy	kód	rozмеры	Cena		
			bez DPH €	s DPH €	s DPH SK
1. OLV - Mosadz leštená	652	79 x 30 mm	5,55	6,61	199,-
2. OGR - Bronz česaný	652	79 x 30 mm	6,61	7,87	237,-
3. ONS - Nikel matný	652	79 x 30 mm	7,19	8,56	258,-
4. N - Nerez masív	2215	87 x 25 mm	12,47	14,84	447,-

ZARÁŽKA DVERÍ NA PODLAHU



TUPAI

povrchy	kód	rozмеры	Cena		
			bez DPH €	s DPH €	s DPH SK
1. N - Nerez masív	1699	22 x 30 mm	3,74	4,45	134,-
2. N - Nerez masív	1698	25 x 43 mm	5,55	6,61	199,-
3. N - Nerez masív	1623	28 x 44 mm	6,11	7,27	219,-

ZARÁŽKA DVERÍ



voľne stojaca
1,25 kg

AXA

povrchy	kód	rozмеры	Cena		
			bez DPH €	s DPH €	s DPH SK
1. N - Nerez masív	FS 48	30 x 48 mm	5,55	6,61	199,-
2. N - Nerez masív	FS 90	33 x 90 mm	13,92	16,56	499,-
3. N - Nerez masív	FS 45	25 x 45 mm	5,55	6,61	199,-
4. N - Nerez masív	FS 65	23 x 65 mm	5,55	6,61	199,-
5. N - Nerez masív	FS 16	80 x 16 mm	7,25	8,63	260,-

STAVEBNÁ VLOŽKA



Pri rozetách od TUPAI odporúčame používať vložku 30/40, aby nebola vložka „utopená“.



povrchy	rozmer	Cena		
		bez DPH €	s DPH €	s DPH SK
Mosadz	30/35 mm	5,30	6,31	190,-
Nikel	30/35 mm	5,30	6,31	190,-
Nikel	30/40 mm	5,55	6,61	199,-

KUKÁTKO



povrchy	hrúbka dverí	rozsah priezoru	Cena		
			bez DPH €	s DPH €	s DPH SK
Chróm	35 - 55 mm	220°	3,99	4,75	143,-
Chróm	podložka 2 ks	48mm+kr	1,08	1,29	39,-
Nikel	35 - 55 mm	220°	4,69	5,58	168,-
Nikel	podložka 2 ks	48mm+kr	1,08	1,29	39,-
Mosadz	35 - 55 mm	220°	3,99	4,75	143,-
Mosadz	podložka 2 ks	48mm+kr	1,08	1,29	39,-
Tmavohnedý s podložkami		220°	4,38	5,21	157,-

GULIČKOVÝ PRUŽINOVÝ ZÁMOK

rozmer 54 x 25 mm

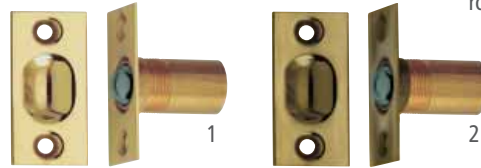

TUPAI

povrch	kód	Cena		
		bez DPH €	s DPH €	s DPH SK
1. Mosadz	973	7,48	8,90	268,-
2. Bronz	973	9,03	10,75	324,-
3. Nikel	973	11,04	13,14	396,-

PLASTOVÝ DORAZ



	Cena		
	bez DPH €	s DPH €	s DPH SK
Plastový doraz	0,70	0,83	25,-

PRÍEMYSELNÁ ZARÁŽKA VEĽKÁ

s vnútornou pružinou



90 x 75 mm	Cena		
	bez DPH €	s DPH €	s DPH SK
strieborná	20,78	24,73	745,-

STAVAČ DVERÍ VEĽKÝ



180 mm	Cena		
	bez DPH €	s DPH €	s DPH SK
1. Zlatý	7,59	9,03	272,-
2. Hnedý	7,59	9,03	272,-
3. Strieborný	7,59	9,03	272,-
4. Biely	7,59	9,03	272,-

STAVAČ DVERÍ MALÝ



130 mm	Cena		
	bez DPH €	s DPH €	s DPH SK
1. Zlatý	4,71	5,61	169,-
2. Hnedý	4,71	5,61	169,-
3. Strieborný	4,71	5,61	169,-
4. Biely	4,71	5,61	169,-

TS 2000 V BC



GEZE

	Cena		
	bez DPH €	s DPH €	s DPH SK

TS 2000 V BC - strieborný, hnedý, biely			
TS 2000 V BC s vodiacou lištou	75,90	90,32	2721,-
podložka k TS 2000 V BC	6,66	7,93	239,-
TS 2000 V BC - zlatý			
TS 2000 V BC s vodiacou lištou	85,1	101,27	3051,-
podložka k TS 2000 V BC	6,66	7,93	239,-

Samozatvárač pre ľavé aj pravé dvere s hydraulickým koncovým dorazom, fixne nastaveným tlmením otvárania a rýchlosti zatvárania. Vhodný pre použitie na ľahšie požiarne a dymotesniace dvere.

Použitie: Vchodové dvere do bytových domov a ľahšie interiérové dvere. Vhodný pre dvere s maximálnou šírkou krídla do 1000 mm.

TS 3000



GEZE

	Cena		
	bez DPH €	s DPH €	s DPH SK

TS 3000 - strieborný, hnedý, biely			
TS 3000 s vodiacou lištou	139,16	165,60	4989,-
aretácia k vodiacej lište	25,08	29,84	899,-
podložka k TS 3000	7,14	8,50	256,-

TS 3000 - zlatý			
TS 3000 s vodiacou lištou	161,71	192,43	5797,-
aretácia k vodiacej lište	25,08	29,84	899,-
podložka k TS 3000	16,34	19,45	586,-

Samozatvárač s hornou montážou pre ľavé aj pravé dvere. Regulovateľná sila zatvárania dverí, rýchlosť zatvárania dverí a koncový doraz. Vhodne pre stredne ťažké požiarne a dymotesniace dvere, pri motnáži odporúčame použiť montážnu podložku.

Použitie: Vchodové dvere do rodinných domov a exteriérové dvere. Maximálna hmotnosť dverí 80 kg. Maximálna šírka krídla dverí 1100 mm.

Kategória veľkosti samozatvárača podľa STN EN 1154 :1-4.

ISM lišta



GEZE

	Cena		
	bez DPH €	s DPH €	s DPH SK

ISM lišta pre 2-krídlové dvere v kombinácii s TS 3000			
- strieborná, hnedá, biela	422,40	502,66	15143,-
- zlatá	453,19	539,30	16247,-
ISM lišta pre 2-krídlové dvere v kombinácii s TS 5000			
- strieborná, hnedá, biela	576,40	685,92	20664,-
- zlatá	633,61	754,00	22715,-

Mechanická koordinácia pre dvoj-krídlové dvere integrovaná do priebežnej lišty.

Možnosť kombinácie s TS 3000 alebo TS 5000.

Ku všetkým typom samozatváračov je možné doobjednať aretáciu (mechanické držanie otvorenia dverí).



TS 5000



strieborný



hnedý



biely



zlatý



Cena

bez DPH € s DPH € s DPH SK

TS 5000 V - strieborný, hnedý, biely

TS 5000 s vodiacou lištou	219,66	261,40	7875,-
aretácia k vodiacej lište	25,08	29,84	899,-
podložka k TS 5000	6,92	8,23	248,-

TS 5000 V - zlatý

TS 5000 s vodiacou lištou	256,01	304,65	9178,-
aretácia k vodiacej lište	25,08	29,84	899,-
podložka k TS 5000	16,13	19,19	578,-

Samozatvárač s hornou montážou pre ľavé aj pravé dvere. Možnosť nastavenia sily zatvárania dverí, rýchlosti zatvárania, hydraulického koncového dorazu a regulovanie tlmenia otvárania. Vhodný na ťažké požiarné a dymotesniace dvere, odporúčame použiť montážnu podložku.

Použitie: Vstupy do úradov, škôl a rôznych inštitúcií. Vhodný do priestorov s vysokou frekvenciou pohybu ľudí. Maximálna hmotnosť dverí 120 kg, maximálna šírka kridla dverí 1400 mm. Kategória veľkosti samozatvárača podľa STN EN 1154 :2-6.

BOXER



Cena

bez DPH € s DPH € s DPH SK

Boxer 2-4	200,11	238,13	7174,-
Boxer 3-6	213,92	254,56	7669,-
Vodiaca lišta pre Boxer	48,31	57,49	1732,-
Vodiaca lišta pre Boxer + aretačný mechanizmus	75,90	90,32	2721,-



strieborný

Boxer 2-4 Integrovaný zatvárač celý zabudovaný do dverného kridla a zárubne. Pri otvorení dverí je viditeľné len tiahlo medzi vodiacou lištou a telom samozatvárača. Vhodný pre pravé aj ľavé dvere. Možnosť mechanického, alebo elektromechanického udržania polohy trvalého otvorenia dverí s plynulým nastavením aretácie od 80° do 120°. Maximálny uhol otvorenia dverí 120°. Nastaviteľná sila zatvárania, rýchlosť zatvárania, tlmenie otvárania dverí a koncový doraz.

Použitie: Pre dvere s maximálnou hmotnosťou 130 kg, maximálnou šírkou kridla dverí 1100 mm a minimálnou hrúbkou kridla dverí 40 mm.

Kategória veľkosti samozatvárača podľa STN EN 1154 :2-4.

Boxer 3-6 Integrovaný zatvárač celý zabudovaný do dverného kridla a zárubne. Pri otvorení dverí je vidieť len tiahlo medzi vodiacou lištou a telom samozatvárača. Vhodný pre pravé aj ľavé dvere. Možnosť mechanického, alebo elektromechanického udržania polohy trvalého otvorenia dverí s plynulým nastavením aretácie od 80° do 120°. Maximálny uhol otvorenia dverí 120°. Nastaviteľná sila zatvárania, rýchlosť zatvárania, tlmenie otvárania dverí a koncový doraz.

Použitie: Hmotnosť dverí maximálne 180 kg, maximálna šírka kridla 1400 mm a minimálna hrúbka kridla dverí 50 mm. Kategória veľkosti samozatvárača podľa STN EN 1154 :3-6.

Ku všetkým typom samozatváračov je možné doobjednať aretáciu (mechanické držanie otvorenia dverí).

GEZE

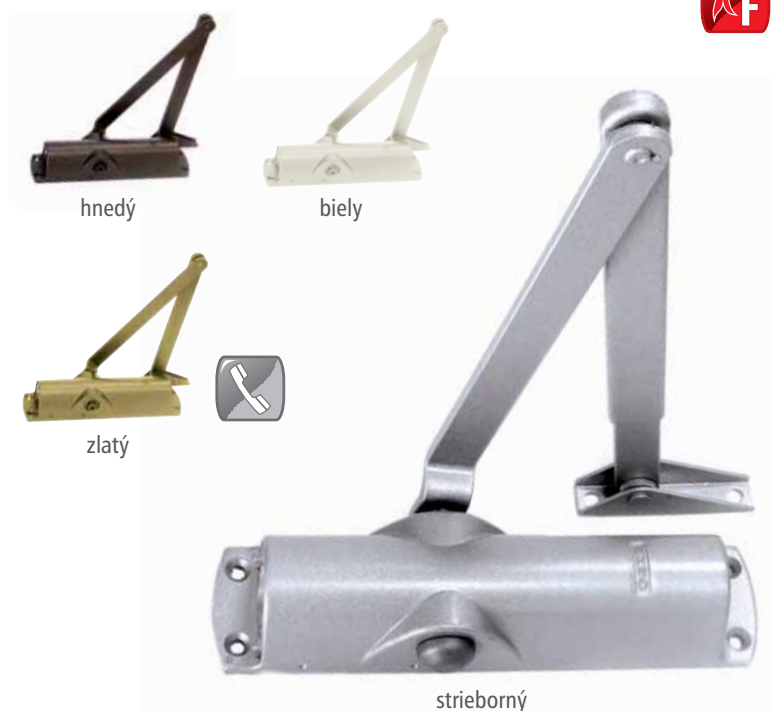

hnedý

biely

zlatý

strieborný



TS 1000

GEZE

	Cena		
	bez DPH €	s DPH €	s DPH SK
TS 1000 - strieborný, hnedý, biely			
TS 1000 s ramienkom	28,76	34,22	1031,-
TS 1000 s aretačným ramienkom	48,48	57,69	1738,-
podložka k TS 1000	6,92	8,23	248,-

TS 1000 - zlatý

TS 1000 s ramienkom	38,66	46,01	1386,-
TS 1000 s aretačným ramienkom	57,69	68,65	2068,-
podložka k TS 1000	16,13	19,19	578,-

Samozatvárač s hornou montážou vhodný pre ľavé aj pravé dvere. Možnosť nastavenia rýchlosti zatvárania dverí a hydraulického koncového dorazu. V prípadoch, keď nie je možné samozatvárač pripevniť na krídlo dverí odporúčame použiť montážnu podložku. Vhodný pre použitie na ľahšie požiarne a dymotesniace dvere.

Použitie: Pre ľahšie interiérové dvere.

Kategória veľkosti samozatvárača podľa STN EN 1154 :3,4.



hnedý

biely

zlatý

strieborný



TS 1500

GEZE

	Cena		
	bez DPH €	s DPH €	s DPH SK
TS 1500 - strieborný, hnedý, biely			
TS 1500 s ramienkom	45,55	54,21	1633,-
TS 1500 s aretačným ramienkom	57,74	68,71	2070,-
podložka k TS 1500	6,92	8,23	248,-

TS 1500 - zlatý

TS 1500 s ramienkom	63,96	76,11	2293,-
TS 1500 s aretačným ramienkom	76,13	90,59	2729,-
podložka k TS 1500	16,13	19,19	578,-

Dizajnový samozatvárač s montážou na dverné krídlo, alebo na zárubňu pre ľavé aj pravé dvere. Možnosť nastavenia rýchlosti zatvárania dverí, sily zatvárania dverí v dvoch veľkostiach a hydraulického koncového dorazu. Vhodný pre použitie na ľahšie požiarne a dymotesniace dvere

Použitie: Vhodný na ľahšie interiérové dvere.

Kategória veľkosti samozatvárača podľa STN EN 1154 :3,4.

Ku všetkým typom samozatváračov je možné doobjednať aretáciu (mechanické držanie otvorenia dverí).

TS 2000



Cena
bez DPH € s DPH € s DPH SK

TS 2000 V - strieborný, hnedý, biely

TS 2000 V s ramienkom	56,82	67,62	2037,-
TS 2000 V s aretačným ramienkom	83,96	99,91	3010,-
TS 2000 V s vyp. aret. ramienkom	89,01	105,92	3191,-
podložka k TS 2000 V	6,66	7,93	239,-

TS 2000 V - zlatý

TS 2000 V s ramienkom	75,90	90,32	2721,-
TS 2000 V s aretačným ramienkom	103,04	122,62	3694,-
TS 2000 V s vyp. aret. ramienkom	108,09	128,63	3875,-
podložka k TS 2000 V	6,66	7,93	239,-

Samozatvárač pre ľavé aj pravé dvere. Možnosť nastavenia rýchlosti zatvárania dverí, sily zatvárania v troch veľkostiach a koncového dorazu. Vhodný pre použitie na stredne ťažké požiarné a dymotesniace dvere.

Použitie: Vchodové dvere do bytových domov a ťažšie interiérové dvere. Maximálna hmotnosť dverí 100 kg, maximálna šírka kridla dverí 1250 mm.

Kategória veľkosti samozatvárača podľa STN EN 1154 :2,4,5.



hnedý

zlatý

biely

strieborný

TS 4000



Cena
bez DPH € s DPH € s DPH SK

TS 4000 - strieborný, hnedý, biely

TS 4000 s ramienkom	105,80	125,90	3793,-
TS 4000 s aretačným ramienkom	132,94	158,20	4766,-
TS 4000 s vypín. aret. ramienkom	138,02	164,24	4948,-
podložka k TS 4000	6,92	8,23	248,-

TS 4000 - zlatý

TS 4000 s ramienkom	124,21	147,81	4453,-
TS 4000 s aretačným ramienkom	151,35	180,11	5426,-
TS 4000 s vypín. aret. ramienkom	156,40	186,12	5607,-
podložka k TS 4000	16,13	19,19	578,-

Samozatvárač s hornou montážou pre ľavé aj pravé dvere. Nastaviteľná sila zatvárania dverí, rýchlosť zatvárania, regulovanie tlmenia otvárania, koncového dorazu a ukazovateľ sily nastavenia. Vhodný na ťažké požiarné a dymotesniace dvere, pri montáži odporúčame použiť montážnu podložku.

Použitie: Vstupy do úradov, škôl a rôznych inštitúcií. Vhodný do priestorov s vysokou frekvenciou pohybu ľudí. Maximálna hmotnosť dverí 120 kg, maximálna šírka kridla dverí 1400 mm. Kategória veľkosti samozatvárača podľa STN EN 1154 :1-6.



hnedý

zlatý

biely

strieborný

Ku všetkým typom samozatváračov je možné doobjednať aretáciu (mechanické držanie otvorenia dverí).

šírky mriežok

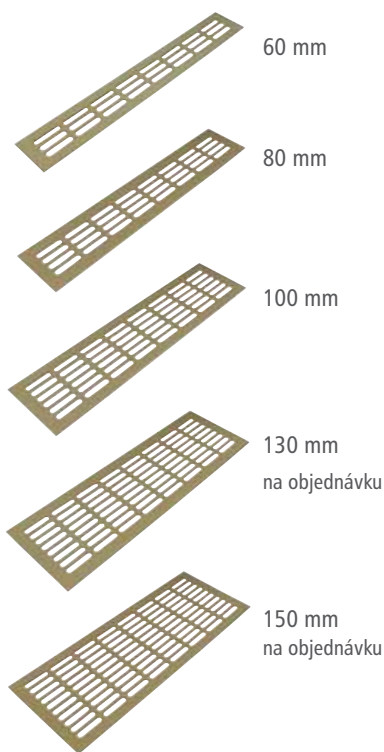

dĺžky mriežok

250 mm
400 mm, 500 mm, 600 mm
800 mm, 1000 mm, 2000 mm

využitie

na odvetranie vstavaných el. spotrebičov
v kuchynských linkách
na kryty radiátorov
na vzduchotechniku
do sadrokartónových priečok
do dverí, atď

montáž

Dĺžka montážneho otvoru je o 25 mm kratšia
ako je celková dĺžka mriežky.

To znamená:
12,5 mm menej z ľavej strany
12,5 mm menej z pravej strany

Šírka montážneho otvoru je o 14mm užšia
ako je celková šírka mriežky.

To znamená:
7 mm menej z ľavej strany
7 mm menej z pravej strany

farebná škála mriežok

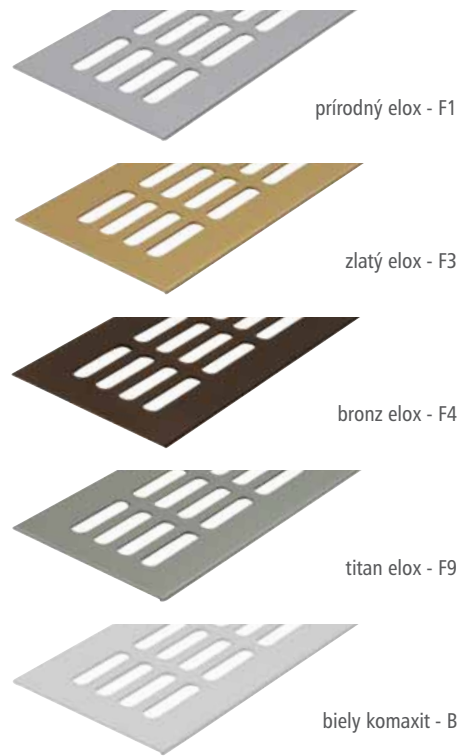

povrchová úprava	250 mm			400 mm			500 mm			600 mm			800 mm			1000 mm			2000 mm		
	bez DPH €	s DPH €	s DPH SK	bez DPH €	s DPH €	s DPH SK	bez DPH €	s DPH €	s DPH SK	bez DPH €	s DPH €	s DPH SK	bez DPH €	s DPH €	s DPH SK	bez DPH €	s DPH €	s DPH SK	bez DPH €	s DPH €	s DPH SK
šírka 60 mm																					
Prírodný elox - F1	4,71	5,61	169,-	5,05	6,01	181,-	5,80	6,90	208,-	6,11	7,27	219,-	8,23	9,79	295,-	9,12	10,85	327,-	16,07	19,12	576,-
Zlatý elox - F3	5,02	5,97	180,-	5,55	6,61	199,-	6,28	7,47	225,-	6,64	7,90	238,-	8,71	10,36	312,-	9,57	11,39	343,-	17,04	20,28	611,-
Bronz elox - F4	5,22	6,21	187,-	6,05	7,20	217,-	6,64	7,90	238,-	6,92	8,23	248,-	9,37	11,15	336,-	10,24	12,18	367,-	18,30	21,78	656,-
Titan elox - F9	5,71	6,80	205,-	6,66	7,93	239,-	7,31	8,70	262,-	7,61	9,06	273,-	10,29	12,25	369,-	11,24	13,38	403,-	20,11	23,93	721,-
Biely komaxit - B	4,82	5,74	173,-	5,08	6,04	182,-	5,97	7,10	214,-	6,30	7,50	226,-	8,54	10,16	306,-	9,79	11,65	351,-	16,93	20,15	607,-
šírka 80 mm																					
Prírodný elox - F1	5,05	6,01	181,-	5,64	6,71	202,-	6,50	7,73	233,-	7,23	8,60	259,-	9,43	11,22	338,-	10,76	12,81	386,-	19,16	22,80	687,-
Zlatý elox - F3	5,30	6,31	190,-	6,00	7,14	215,-	6,95	8,27	249,-	7,65	9,10	274,-	9,82	11,68	352,-	11,38	13,54	408,-	20,59	24,50	738,-
Bronz elox - F4	5,61	6,67	201,-	6,66	7,93	239,-	7,34	8,73	263,-	8,03	9,56	288,-	10,49	12,48	376,-	11,86	14,11	425,-	21,67	25,79	777,-
Titan elox - F9	6,17	7,34	221,-	7,34	8,73	263,-	8,09	9,63	290,-	8,84	10,52	317,-	11,55	13,74	414,-	13,03	15,50	467,-	23,87	28,41	856,-
Biely komaxit - B	5,27	6,27	189,-	5,75	6,84	206,-	6,81	8,10	244,-	7,50	8,93	269,-	9,73	11,58	349,-	11,82	14,07	424,-	21,29	25,33	763,-
šírka 100 mm																					
Prírodný elox - F1	5,30	6,31	190,-	6,41	7,63	230,-	7,50	8,93	269,-	7,95	9,46	285,-	10,49	12,48	376,-	12,08	14,37	433,-	22,12	26,32	793,-
Zlatý elox - F3	5,69	6,77	204,-	6,61	7,87	237,-	7,67	9,13	275,-	8,37	9,96	300,-	11,10	13,21	398,-	12,89	15,34	462,-	23,60	28,08	846,-
Bronz elox - F4	5,80	6,90	208,-	7,14	8,50	256,-	8,20	9,76	294,-	9,01	10,72	323,-	11,74	13,97	421,-	13,61	16,20	488,-	25,10	29,87	900,-
Titan elox - F9	6,45	7,67	231,-	7,87	9,36	282,-	9,07	10,79	325,-	8,14	9,69	292,-	12,92	15,37	463,-	14,98	17,83	537,-	27,59	32,83	989,-
Biely komaxit - B	5,61	6,67	201,-	6,41	7,63	230,-	7,56	9,00	271,-	8,92	10,62	320,-	11,13	13,24	399,-	13,34	15,87	478,-	23,51	27,98	843,-
šírka 130 mm																					
Prírodný elox - F1	5,83	6,94	209,-	7,36	8,76	264,-	8,31	9,89	298,-	9,32	11,09	334,-	12,16	14,47	436,-	14,08	16,76	505,-	26,03	30,97	933,-
Zlatý elox - F3	7,17	8,53	257,-	7,84	9,33	281,-	8,87	10,56	318,-	9,98	11,88	358,-	12,81	15,24	459,-	14,87	17,69	533,-	27,95	33,26	1002,-
Bronz elox - F4	7,39	8,80	265,-	8,26	9,83	296,-	9,43	11,22	338,-	11,02	13,11	395,-	14,08	16,76	505,-	16,62	19,78	596,-	31,10	37,01	1115,-
Titan elox - F9	8,14	9,69	292,-	9,09	10,82	326,-	10,40	12,38	373,-	9,29	11,05	333,-	15,48	18,42	555,-	18,30	21,78	656,-	34,23	40,73	1227,-
Biely komaxit - B	7,08	8,43	254,-	7,67	9,13	275,-	8,18	9,73	293,-	10,60	12,61	380,-	13,17	15,67	472,-	15,06	17,92	540,-	28,59	34,02	1025,-
šírka 150 mm																					
Prírodný elox - F1	6,41	7,63	230,-	8,23	9,79	295,-	9,62	11,45	345,-	11,41	13,58	409,-	14,98	17,83	537,-	17,18	20,45	616,-	33,36	39,70	1196,-
Zlatý elox - F3	7,67	9,13	275,-	8,73	10,39	313,-	10,29	12,25	369,-	11,80	14,04	423,-	16,04	19,09	575,-	18,63	22,17	668,-	36,04	42,89	1292,-
Bronz elox - F4	7,89	9,39	283,-	9,29	11,05	333,-	10,63	12,65	381,-	12,94	15,40	464,-	16,62	19,78	596,-	19,39	23,07	695,-	37,44	44,55	1342,-
Titan elox - F9	8,73	10,39	313,-	10,24	12,18	367,-	11,69	13,91	419,-	10,93	13,01	392,-	18,30	21,78	656,-	21,37	25,43	766,-	41,20	49,03	1477,-
Biely komaxit - B	7,61	9,06	273,-	8,56	10,19	307,-	9,96	11,85	357,-	8,23	9,79	295,-	15,31	18,22	549,-	17,66	21,01	633,-	36,18	43,05	1297,-

Vetrací otvor na mriežke má rozmer 7 x 40 mm

šírky mriežok

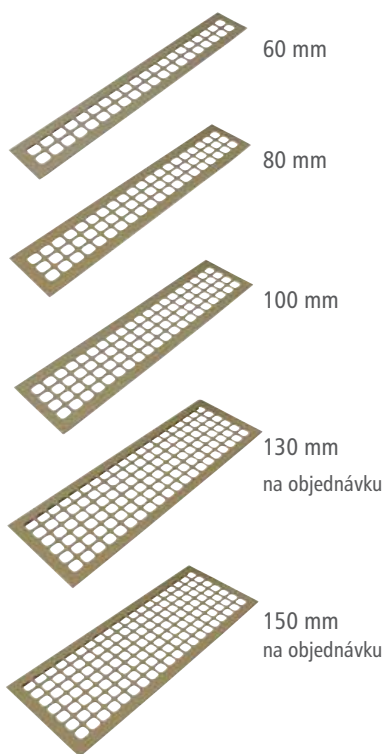

dĺžky mriežok

250 mm
400 mm, 500 mm, 600 mm
800 mm, 1000 mm, 2000 mm

využitie

na odvetranie vstavaných el. spotrebičov
v kuchynských linkách
na kryty radiátorov
na vzduchotechniku
do sadrokartónových priečok
do dverí, atď

montáž

Dĺžka montážneho otvoru je o 25 mm kratšia
ako je celková dĺžka mriežky.

To znamená:

12,5 mm menej z ľavej strany
12,5 mm menej z pravej strany

Šírka montážneho otvoru je o 14mm užšia
ako je celková šírka mriežky.

To znamená:

7 mm menej z ľavej strany
7 mm menej z pravej strany

farebná škála mriežok

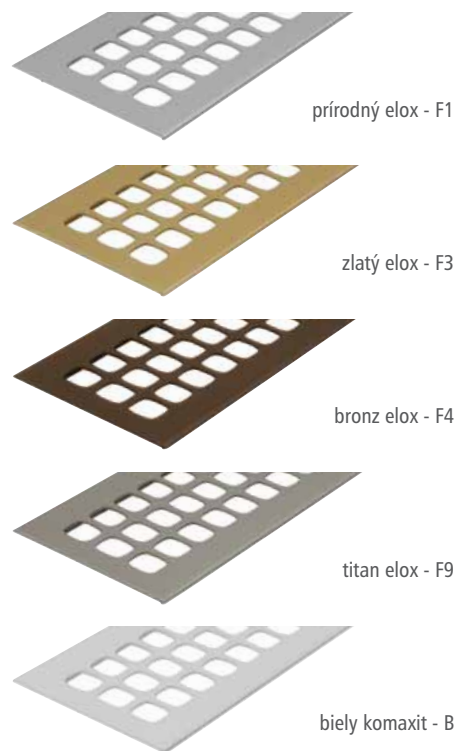

povrchová úprava	250 mm			400 mm			500 mm			600 mm			800 mm			1000 mm			2000 mm			
	bez DPH €	s DPH €	s DPH SK	bez DPH €	s DPH €	s DPH SK	bez DPH €	s DPH €	s DPH SK	bez DPH €	s DPH €	s DPH SK	bez DPH €	s DPH €	s DPH SK	bez DPH €	s DPH €	s DPH SK	bez DPH €	s DPH €	s DPH SK	
šírka 60 mm																						
Prírodný elox - F1	4,71	5,61	169,-	5,05	6,01	181,-	5,80	6,90	208,-	6,11	7,27	219,-	8,23	9,79	295,-	9,12	10,85	327,-	16,07	19,12	576,-	
Zlatý elox - F3	5,02	5,97	180,-	5,55	6,61	199,-	6,28	7,47	225,-	6,64	7,90	238,-	8,71	10,36	312,-	9,57	11,39	343,-	17,04	20,28	611,-	
Bronz elox - F4	5,22	6,21	187,-	6,05	7,20	217,-	6,64	7,90	238,-	6,92	8,23	248,-	9,37	11,15	336,-	10,24	12,18	367,-	18,30	21,78	656,-	
Titan elox - F9	5,71	6,80	205,-	6,66	7,93	239,-	7,31	8,70	262,-	7,61	9,06	273,-	10,29	12,25	369,-	11,24	13,38	403,-	20,11	23,93	721,-	
Biely komaxit - B	4,82	5,74	173,-	5,08	6,04	182,-	5,97	7,10	214,-	6,30	7,50	226,-	8,54	10,16	306,-	9,79	11,65	351,-	16,93	20,15	607,-	
šírka 80 mm																						
Prírodný elox - F1	5,05	6,01	181,-	5,64	6,71	202,-	6,50	7,73	233,-	7,23	8,60	259,-	9,43	11,22	338,-	10,76	12,81	386,-	19,16	22,80	687,-	
Zlatý elox - F3	5,30	6,31	190,-	6,00	7,14	215,-	6,95	8,27	249,-	7,65	9,10	274,-	9,82	11,68	352,-	11,38	13,54	408,-	20,59	24,50	738,-	
Bronz elox - F4	5,61	6,67	201,-	6,66	7,93	239,-	7,34	8,73	263,-	8,03	9,56	288,-	10,49	12,48	376,-	11,86	14,11	425,-	21,67	25,79	777,-	
Titan elox - F9	6,17	7,34	221,-	7,34	8,73	263,-	8,09	9,63	290,-	8,84	10,52	317,-	11,55	13,74	414,-	13,03	15,50	467,-	23,87	28,41	856,-	
Biely komaxit - B	5,27	6,27	189,-	5,75	6,84	206,-	6,81	8,10	244,-	7,50	8,93	269,-	9,73	11,58	349,-	11,82	14,07	424,-	21,29	25,33	763,-	
šírka 100 mm																						
Prírodný elox - F1	5,30	6,31	190,-	6,41	7,63	230,-	7,50	8,93	269,-	7,95	9,46	285,-	10,49	12,48	376,-	12,08	14,37	433,-	22,12	26,32	793,-	
Zlatý elox - F3	5,69	6,77	204,-	6,61	7,87	237,-	7,67	9,13	275,-	8,37	9,96	300,-	11,10	13,21	398,-	12,89	15,34	462,-	23,60	28,08	846,-	
Bronz elox - F4	5,80	6,90	208,-	7,14	8,50	256,-	8,20	9,76	294,-	9,01	10,72	323,-	11,74	13,97	421,-	13,61	16,20	488,-	25,10	29,87	900,-	
Titan elox - F9	6,45	7,67	231,-	7,87	9,36	282,-	9,07	10,79	325,-	8,14	9,69	292,-	12,92	15,37	463,-	14,98	17,83	537,-	27,59	32,83	989,-	
Biely komaxit - B	5,61	6,67	201,-	6,41	7,63	230,-	7,56	9,00	271,-	8,92	10,62	320,-	11,13	13,24	399,-	13,34	15,87	478,-	23,51	27,98	843,-	
šírka 130 mm																						
Prírodný elox - F1	5,83	6,94	209,-	7,36	8,76	264,-	8,31	9,89	298,-	9,32	11,09	334,-	12,16	14,47	436,-	14,08	16,76	505,-	26,03	30,97	933,-	
Zlatý elox - F3	7,17	8,53	257,-	7,84	9,33	281,-	8,87	10,56	318,-	9,98	11,88	358,-	12,81	15,24	459,-	14,87	17,69	533,-	27,95	33,26	1002,-	
Bronz elox - F4	7,39	8,80	265,-	8,26	9,83	296,-	9,43	11,22	338,-	11,02	13,11	395,-	14,08	16,76	505,-	16,62	19,78	596,-	31,10	37,01	1115,-	
Titan elox - F9	8,14	9,69	292,-	9,09	10,82	326,-	10,40	12,38	373,-	9,29	11,05	333,-	15,48	18,42	555,-	18,30	21,78	656,-	34,23	40,73	1227,-	
Biely komaxit - B	7,08	8,43	254,-	7,67	9,13	275,-	8,18	9,73	293,-	10,60	12,61	380,-	13,17	15,67	472,-	15,06	17,92	540,-	28,59	34,02	1025,-	
šírka 150 mm																						
Prírodný elox - F1	6,41	7,63	230,-	8,23	9,79	295,-	9,62	11,45	345,-	11,41	13,58	409,-	14,98	17,83	537,-	17,18	20,45	616,-	33,36	39,70	1196,-	
Zlatý elox - F3	7,67	9,13	275,-	8,73	10,39	313,-	10,29	12,25	369,-	11,80	14,04	423,-	16,04	19,09	575,-	18,63	22,17	668,-	36,04	42,89	1292,-	
Bronz elox - F4	7,89	9,39	283,-	9,29	11,05	333,-	10,63	12,65	381,-	12,94	15,40	464,-	16,62	19,78	596,-	19,39	23,07	695,-	37,44	44,55	1342,-	
Titan elox - F9	8,73	10,39	313,-	10,24	12,18	367,-	11,69	13,91	419,-	10,93	13,01	392,-	18,30	21,78	656,-	21,37	25,43	766,-	41,20	49,03	1477,-	
Biely komaxit - B	7,61	9,06	273,-	8,56	10,19	307,-	9,96	11,85	357,-	8,23	9,79	295,-	15,31	18,22	549,-	17,66	21,01	633,-	36,18	43,05	1297,-	

Vetrací otvor na mriežke má rozmer 14 x 15 mm

šírky mriežok

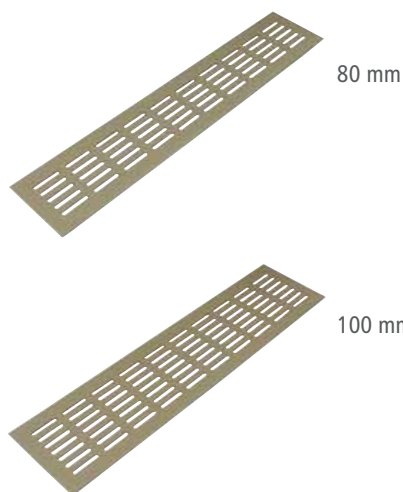

80 mm

100 mm

dĺžky mriežok

400 mm, 500 mm, 600 mm
800 mm, 1000 mm, 2000 mm

využitie

na odvetranie vstavaných el. spotrebičov
v kuchynských linkách
na kryty radiátorov
na vzduchotechniku
do sadrokartónových priečok
do dverí, atď

montáž

Dĺžka montážneho otvoru je o 25 mm kratšia
ako je celková dĺžka mriežky.
To znamená:
12,5 mm menej z ľavej strany
12,5 mm menej z pravej strany

Šírka montážneho otvoru je o 14mm užšia
ako je celková šírka mriežky.
To znamená:
7 mm menej z ľavej strany
7 mm menej z pravej strany

farebná škála mriežok

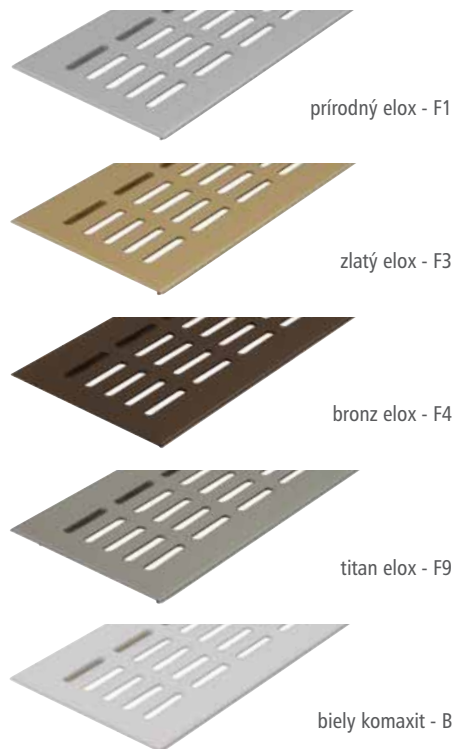

prírodný elox - F1

zlatý elox - F3

bronz elox - F4

titan elox - F9

biely komaxit - B

povrchová úprava	400 mm			500 mm			600 mm			800 mm			1000 mm			2000 mm		
	bez DPH €	s DPH €	s DPH SK	bez DPH €	s DPH €	s DPH SK	bez DPH €	s DPH €	s DPH SK	bez DPH €	s DPH €	s DPH SK	bez DPH €	s DPH €	s DPH SK	bez DPH €	s DPH €	s DPH SK
šírka 80 mm																		
Prírodný elox - F1	5,64	6,71	202,-	6,50	7,73	233,-	7,23	8,60	259,-	9,43	11,22	338,-	10,76	12,81	386,-	19,16	22,80	687,-
Zlatý elox - F3	6,00	7,14	215,-	6,95	8,27	249,-	7,65	9,10	274,-	9,82	11,68	352,-	11,38	13,54	408,-	20,59	24,50	738,-
Bronz elox - F4	6,66	7,93	239,-	7,34	8,73	263,-	8,03	9,56	288,-	10,49	12,48	376,-	11,86	14,11	425,-	21,67	25,79	777,-
Titan elox - F9	7,34	8,73	263,-	8,09	9,63	290,-	8,84	10,52	317,-	11,55	13,74	414,-	13,03	15,50	467,-	23,87	28,41	856,-
Biely komaxit - B	5,75	6,84	206,-	6,81	8,10	244,-	7,50	8,93	269,-	9,73	11,58	349,-	11,82	14,07	424,-	21,29	25,33	763,-
šírka 100 mm																		
Prírodný elox - F1	6,41	7,63	230,-	7,50	8,93	269,-	7,95	9,46	285,-	10,49	12,48	376,-	12,08	14,37	433,-	22,12	26,32	793,-
Zlatý elox - F3	6,61	7,87	237,-	7,67	9,13	275,-	8,37	9,96	300,-	11,10	13,21	398,-	12,89	15,34	462,-	23,60	28,08	846,-
Bronz elox - F4	7,14	8,50	256,-	8,20	9,76	294,-	9,01	10,72	323,-	11,74	13,97	421,-	13,61	16,20	488,-	25,10	29,87	900,-
Titan elox - F9	7,87	9,36	282,-	9,07	10,79	325,-	8,14	9,69	292,-	12,92	15,37	463,-	14,98	17,83	537,-	27,59	32,83	989,-
Biely komaxit - B	6,41	7,63	230,-	7,56	9,00	271,-	8,92	10,62	320,-	11,13	13,24	399,-	13,34	15,87	478,-	23,51	27,98	843,-

Vetrací otvor na mriežke má rozmer 4 x 30 mm

PLASTOVÉ VETRACIE MRIEŽKY



VETRACIA MRIEŽKA

povrch | biela

Rozmery v mm		Cena		
vonkajší	otvor vo dverách	bez DPH €	s DPH €	s DPH SK
450 x 134	438 x 123	4,33	5,15	155,-



VETRACIA MRIEŽKA

povrch | šedá

Rozmery v mm		Cena		
vonkajší	otvor vo dverách	bez DPH €	s DPH €	s DPH SK
450 x 134	438 x 123	4,33	5,15	155,-



VETRACIA MRIEŽKA

povrch | strieborná

Rozmery v mm		Cena		
vonkajší	otvor vo dverách	bez DPH €	s DPH €	s DPH SK
450 x 134	438 x 123	8,31	9,89	298,-

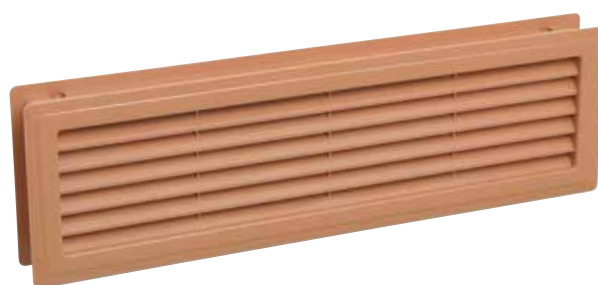

VETRACIA MRIEŽKA

povrch | okrová

Rozmery v mm		Cena		
vonkajší	otvor vo dverách	bez DPH €	s DPH €	s DPH SK
450 x 134	438 x 123	4,33	5,15	155,-



VETRACIA MRIEŽKA

povrch | bledohnedá

Rozmery v mm		Cena		
vonkajší	otvor vo dverách	bez DPH €	s DPH €	s DPH SK
450 x 134	438 x 123	4,33	5,15	155,-



VETRACIA MRIEŽKA

povrch | tmavohnedá

Rozmery v mm		Cena		
vonkajší	otvor vo dverách	bez DPH €	s DPH €	s DPH SK
450 x 134	438 x 123	4,33	5,15	155,-



1, 2

3

5

4

6

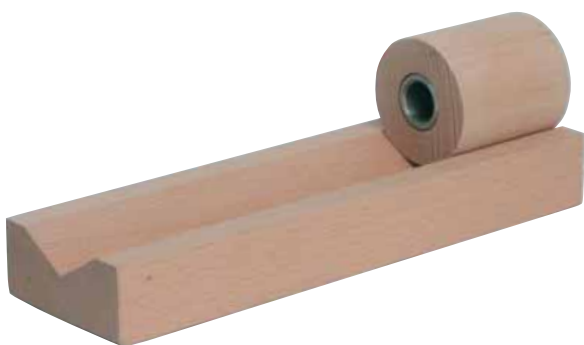

7

DREVENÉ LAKOVANÉ MADLÁ Ø45 mm

	druh dreva	Cena		
		bez DPH €	s DPH €	s DPH SK
1 madlo, dĺžka 150 cm	buk	36,57	43,52	1311,-
madlo, dĺžka 150 cm	javor	53,17	63,27	1906,-
2 madlo, dĺžka 225 cm	buk	49,73	59,18	1783,-
madlo, dĺžka 225 cm	javor	82,15	97,76	2945,-
3 koncovka	buk	3,96	4,71	142,-
koncovka	javor	3,96	4,71	142,-
4 oblúk, uhol 45°	buk	15,37	18,29	551,-
oblúk, uhol 45°	javor	20,25	24,10	726,-
5 oblúk, uhol 76°, radius 10,6 cm	buk	15,37	18,29	551,-
oblúk, uhol 76°, radius 10,6 cm	javor	20,25	24,10	726,-
6 oblúk, uhol 90°, radius 10 cm	buk	15,37	18,29	551,-
oblúk, uhol 90°, radius 10 cm	javor	20,25	24,10	726,-
7 šablóna na vŕtanie otvorov pre kolík	buk	30,21	35,95	1083,-

DRŽIAK DREVENÉHO MADLA



povrchy	kód	rozmery	Cena		
			bez DPH €	s DPH €	s DPH SK
1. N - Nerez	0120	(80x80mm)	10,13	12,05	363,-
2. N - Nerez	0130	(60x74mm)	8,26	9,83	296,-

DRŽIAK DREVENÉHO MADLA 409L



povrchy	kód	rozmery	Cena		
			bez DPH €	s DPH €	s DPH SK
1. B - Biely	409L	(80x80mm)	5,13	6,11	184,-
2. Čierny	409L	(80x80mm)	5,13	6,11	184,-
3. Kované železo	409L	(80x80mm)	5,64	6,71	202,-

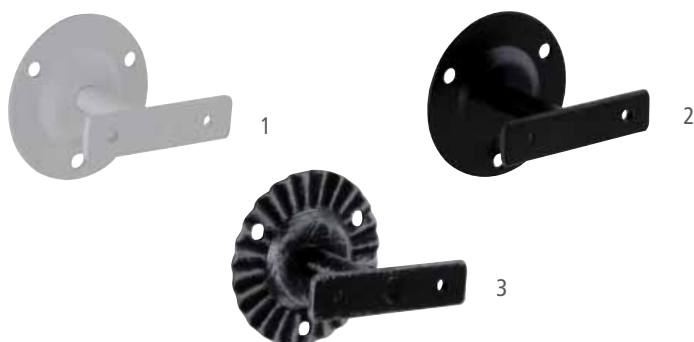

DRŽIAK DREVENÉHO MADLA 409T

povrchy	kód	rozmery	Cena		
			bez DPH €	s DPH €	s DPH SK
1. B - Biely	409T	(60x80mm)	4,77	5,68	171,-
2. Čierny	409T	(60x80mm)	4,77	5,68	171,-
3. Kované železo	409T	(60x80mm)	5,39	6,41	193,-

DRŽIAK DREVENÉHO MADLA 2803

rozmery | 50 x 65 mm



povrchy	Cena		
	bez DPH €	s DPH €	s DPH SK
1. B - Biely	7,87	9,36	282,-
2. OC - Chróm lesklý	7,87	9,36	282,-
3. ONS - Nikel brúsený	7,87	9,36	282,-
4. OLV - Mosadz lesklá	6,89	8,20	247,-
5. OGR - Bronz česaný	6,89	8,20	247,-

DRŽIAK DREVENÉHO MADLA 2805

rozmery | 70 x 75 mm



povrchy	Cena		
	bez DPH €	s DPH €	s DPH SK
1. B - Biely	11,27	13,41	404,-
2. OC - Chróm lesklý	13,00	15,47	466,-
3. OCS - brúsený	13,00	15,47	466,-
4. ONS - Nikel brúsený	13,00	15,47	466,-
5. OLV - Mosadz lesklá	10,13	12,05	363,-
6. OGR - Bronz česaný	10,13	12,05	363,-

OBLOŽKOVÉ TESNENIE EV 3967 KS

PRE FALC 12 a 15mm

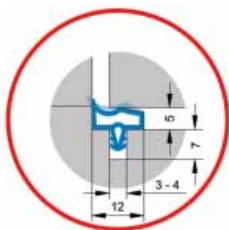

Kvalita:

EV modifikovaný elastický polymér

Vlastnosti:

Veľmi dobré fyzikálne vlastnosti, odoláva poveternostným vplyvom, dobrá tvarová stabilita, vysoká flexibilita, použiteľný v tenkostennom prevedení.

Použité skratky:

Fh Výška hlavy profilu

Al Tesnená medzera

Fb Šírka hlavy profilu

Nt Hĺbka drážky

Nb Šírka drážky

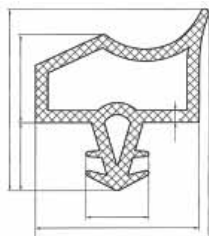

Cena / m

farba	Fb	Fh	Al	Nt	Nb	bez DPH €	s DPH €	s DPH SK
biela, béžová, hnedá, mahagón	12	13	5	7	3-4	0,67	0,80	24,-

ELLEN MATIC OMEGA



Automatické tesnenie spodnej hrany dverí pre dvere otvárajúce sa do vnútra a von. Automatické tesnenie pre rýchle a bezproblémové zabudovanie. Tento dverový automat musí byť montovaný na strane pántov dverí s oporným plechom proti nastaviteľnému dorazu, ktorý znižuje vnútornú konštrukciu. Tesnenie je z dutého silikónového profilu. ELLEN MATIC OMEGA má automatický mechanizmus priečneho nastavenia k dosadnutiu na nerovnakej úrovni podláh, alebo prahov. Široké upevňovacie krídla montované jednoducho pod list dverí uľahčujú montáž. Obzvlášť vhodné k dovybaveniu. Automat v PE obale, príslušný oporný plech a skrutky sa nachádzajú v PE vrecku.

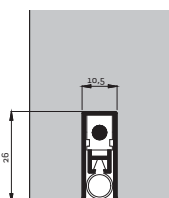

Šírka drážky:

11 mm

Hĺbka drážky:

26 mm

Maximálne vysunutie:

10 mm

Štandardná dĺžka:

63, 73, 83, 93, 103,
113 a 123 cm

Skrátenie max. o:

100 mm

Cena

dĺžka v cm	bez DPH €	s DPH €	s DPH SK
63	22,79	27,12	817,-
73	22,87	27,22	820,-
83	23,71	28,21	850,-
93	24,55	29,21	880,-
103	25,24	30,04	905,-

ELLEN MATIC PRIMERA - JEDNODUCHÝ, MNOHOSTRANNÝ



ELLEN MATIC PRIMERA môže byť jednoducho namontovaný, jednoducho skrútený a jednoducho upravený. Je odolný voči dymu a ohňovzdorný (T30) vďaka špeciálnemu penovému profilu. Vnútorný automaticky nastavovateľný mechanizmus umožňuje použitie pri akomkoľvek sklone podlahy. Spúšťa sa, keď sa aktivačná skrutka opiera o rám dverí na strane závesu, alebo na strane zámku. Vhodný pre vonkajšie aj vnútorné dvere.

Šírka drážky:

17 mm

Hĺbka drážky:

39 mm

Maximálna veľkosť tesnenej medzery:

10 mm

Maximálny výsuv:

12 mm

Štandardné dĺžky:

63, 73, 83, 93, 103,
113, 123 cm

Skrátenie maximálne o:

100 mm

Iné a špeciálne veľkosti:

na požiadanie

Požadovaná dĺžka:

podľa šírky dverného
krídla

Cena

dĺžka v cm	bez DPH €	s DPH €	s DPH SK
63	45,88	54,60	1645,-
73	49,26	58,62	1766,-
83	52,16	62,07	1870,-
93	55,03	65,49	1973,-
103	57,91	68,91	2076,-
113	60,87	72,43	2182,-
123	63,91	76,05	2291,-

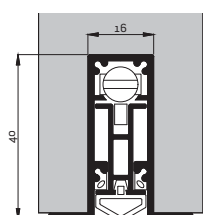

TESNENIE DVERÍ - DBS NEVIDITEĽNÉ UCHYTENIE

Tesnenie dverí (pod dvere). Lišty sú predvŕtané dierami o priemere 3 mm. Vzdialenosť dier je cca 15 cm. Profil DBS sa skladá z hliníkovej nosnej lišty a flexibilnej polypropylénovej kefy, ktorá je neviditeľne zaskrutkovaná pod dvere.

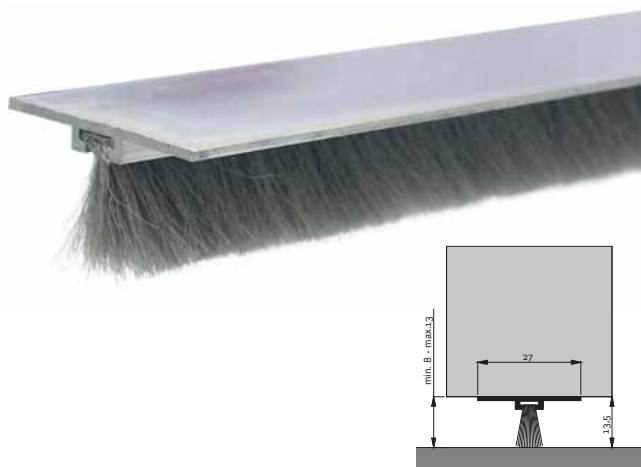

	dĺžka v cm	špára v mm	Cena		
			bez DPH €	s DPH €	s DPH SK
DBS - hliník	100	8 - 13	8,14	9,69	292,-

HLINÍKOVÝ PRAH S TESNENÍM

Hliníkový prah AKW - dvojdielny s uchytením spodného dielu, umožňuje široké použitie - dvere, posuvné sklenené dvere (vtedy je tesnenie nahradené velúrovou kefou), miesto pre ťahanie káblov, vchody do obchodov, montované pódia, vjazdy do garáží a pod. V základnej pozícii (obrázok č. 3) šírka 63 mm, výška 20 mm, dĺžka 180 cm. Pozícia 1. a 2. vyjadrujú postup na nasadenie horného dielu a zklapnutie (3).

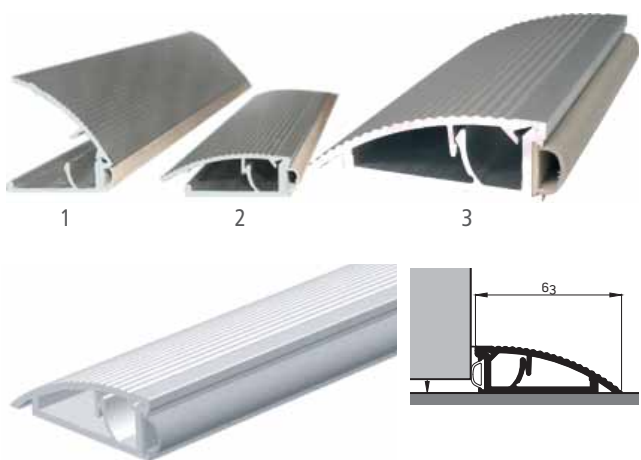

	dĺžka v cm	Cena		
		bez DPH €	s DPH €	s DPH SK
AKW prah 180 cm	180	73,13	87,03	2622,-

TESNENIE DVERÍ - IDS S ELEGANTNÝM NEVIDITEĽNÝM UCHYTENÍM

Keď je určená pre rôzne druhy podláh, s výnimkou drevenej podlahy. Jednoduché skryté uchytenie i pomocou dištančnej skrutky.

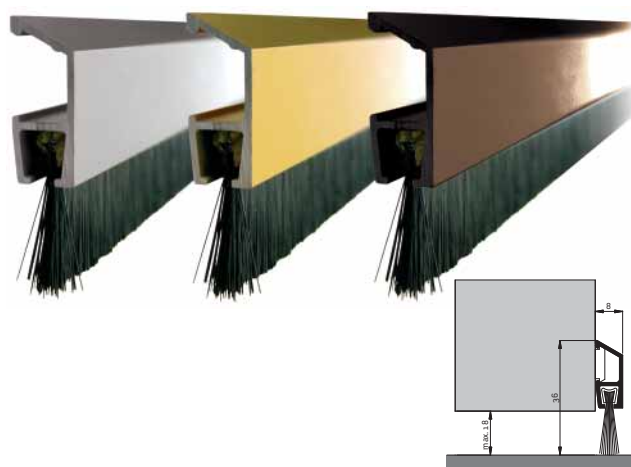

	dĺžka v cm	špára v mm	Cena		
			bez DPH €	s DPH €	s DPH SK
IDS - BA elox strieborný	100	18	12,72	15,14	456,-
IDS - BG elox zlatý	100	18	12,64	15,04	453,-
IDS - BB elox hnedý	100	18	14,82	17,63	531,-

HLINÍKOVÝ OCHRANNO-NÁŠĽAPNÝ PROFIL S TESNENÍM

Hliníkový ochranný-nášľapný profil z eloxovaného hliníka striebornej farby s nášľapnou šírkou 45, 55, alebo 70 mm s dutým tesniacim profilom z PVC. Lepenie silikónovým tmelom. Výškovo nastaviteľné čelo AL prahu, zníženie profilu docielime odtočením perforovaných pásov v mieste perforácie, podľa výšky dreveného prahu.

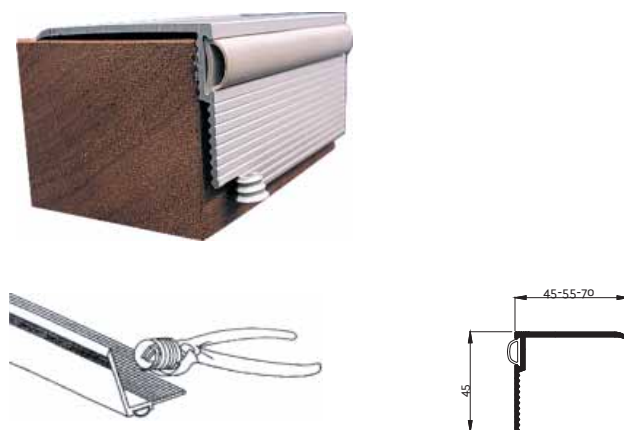

	dĺžka v cm	Cena		
		bez DPH €	s DPH €	s DPH SK
ARP - 45 prahová lišta	180	24,21	28,81	868,-
ARP - 55 prahová lišta	180	26,11	31,07	936,-
ARP - 70 prahová lišta	180	27,39	32,60	982,-

DREVENÉ PRAHY

00



Buk prírodný lakovaný

01

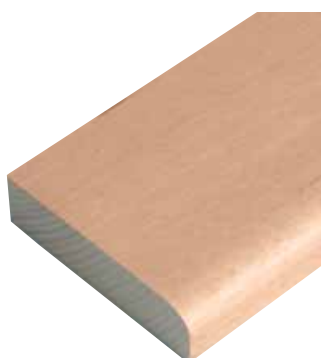

Buk parený lakovaný

02



Dub lakovaný prírodný

03

Buk morený a lakovaný,
odtieň jelša

BUK BRÚSENÝ BEZ POVRCHOVEJ ÚPRAVY:

	60 cm			70 cm			80 cm			90 cm			100 cm			110 cm		
	bez DPH €	s DPH €	s DPH SK	bez DPH €	s DPH €	s DPH SK	bez DPH €	s DPH €	s DPH SK	bez DPH €	s DPH €	s DPH SK	bez DPH €	s DPH €	s DPH SK	bez DPH €	s DPH €	s DPH SK
8 cm	4,29	5,11	154,-	4,97	5,91	178,-	5,75	6,84	206,-	6,41	7,63	230,-	7,11	8,46	255,-	7,81	9,29	280,-
10 cm	4,82	5,74	173,-	5,66	6,74	203,-	6,50	7,73	233,-	7,25	8,63	260,-	8,03	9,56	288,-	8,87	10,56	318,-
12 cm	5,80	6,90	208,-	6,72	8,00	241,-	7,65	9,10	274,-	8,65	10,29	310,-	9,62	11,45	345,-	10,63	12,65	381,-
14 cm	6,72	8,00	241,-	7,87	9,36	282,-	9,01	10,72	323,-	10,10	12,02	362,-	11,24	13,38	403,-	12,39	14,74	444,-

BUK MORENÝ A LAKOVANÝ: PRÍRODNÝ - 00, PARENÝ - 01, JELŠA - 03, ČEREŠŇA - 05, ORECH - 07

	60 cm			70 cm			80 cm			90 cm			100 cm			110 cm		
	bez DPH €	s DPH €	s DPH SK	bez DPH €	s DPH €	s DPH SK	bez DPH €	s DPH €	s DPH SK	bez DPH €	s DPH €	s DPH SK	bez DPH €	s DPH €	s DPH SK	bez DPH €	s DPH €	s DPH SK
8 cm	4,82	5,74	173,-	5,66	6,74	203,-	6,50	7,73	233,-	7,25	8,63	260,-	8,03	9,56	288,-	8,87	10,56	318,-
10 cm	5,58	6,64	200,-	6,50	7,73	233,-	7,42	8,83	266,-	8,34	9,92	299,-	9,26	11,02	332,-	10,15	12,08	364,-
12 cm	6,58	7,83	236,-	7,65	9,10	274,-	8,71	10,36	312,-	9,79	11,65	351,-	10,85	12,91	389,-	11,91	14,17	427,-
14 cm	7,50	8,93	269,-	8,71	10,36	312,-	9,93	11,82	356,-	11,24	13,38	403,-	12,47	14,84	447,-	13,67	16,27	490,-

DUB BRÚSENÝ BEZ POVRCHOVEJ ÚPRAVY:

	60 cm			70 cm			80 cm			90 cm			100 cm			110 cm		
	bez DPH €	s DPH €	s DPH SK	bez DPH €	s DPH €	s DPH SK	bez DPH €	s DPH €	s DPH SK	bez DPH €	s DPH €	s DPH SK	bez DPH €	s DPH €	s DPH SK	bez DPH €	s DPH €	s DPH SK
8 cm	4,82	5,74	173,-	5,66	6,74	203,-	6,50	7,73	233,-	7,25	8,63	260,-	8,03	9,56	288,-	8,87	10,56	318,-
10 cm	5,22	6,21	187,-	6,05	7,20	217,-	6,89	8,20	247,-	7,81	9,29	280,-	8,65	10,29	310,-	9,49	11,29	340,-
12 cm	6,36	7,57	228,-	7,42	8,83	266,-	8,48	10,09	304,-	9,57	11,39	343,-	10,63	12,65	381,-	11,69	13,91	419,-
14 cm	8,12	9,66	291,-	9,49	11,29	340,-	10,85	12,91	389,-	12,16	14,47	436,-	13,53	16,10	485,-	14,90	17,73	534,-

DUB MORENÝ A LAKOVANÝ: PRÍRODNÝ - 02, ORECH - 08, WENGE - 09

	60 cm			70 cm			80 cm			90 cm			100 cm			110 cm		
	bez DPH €	s DPH €	s DPH SK	bez DPH €	s DPH €	s DPH SK	bez DPH €	s DPH €	s DPH SK	bez DPH €	s DPH €	s DPH SK	bez DPH €	s DPH €	s DPH SK	bez DPH €	s DPH €	s DPH SK
8 cm	5,44	6,47	195,-	6,36	7,57	228,-	7,25	8,63	260,-	8,12	9,66	291,-	9,01	10,72	323,-	9,93	11,82	356,-
10 cm	5,88	7,00	211,-	6,89	8,20	247,-	7,81	9,29	280,-	8,79	10,46	315,-	9,79	11,65	351,-	10,76	12,81	386,-
12 cm	7,11	8,46	255,-	8,34	9,92	299,-	9,49	11,29	340,-	10,71	12,75	384,-	11,86	14,11	425,-	13,05	15,53	468,-
14 cm	8,34	9,92	299,-	9,71	11,55	348,-	11,08	13,18	397,-	12,52	14,90	449,-	13,92	16,56	499,-	15,29	18,19	548,-

Hrúbka prahov: 20 mm

Povrchová úprava: 3 vrstvy PU laku

Drevené prahy sú čiastočne naskladnené. Väčšie zákazky na objednávku.

Na požiadanie zákazníka vyrobíme do prahu drážku a osadíme tesnenie. Cena tejto úpravy je 1,66 € bez DPH (50,-SK) za 1 bežný meter.

DREVENÉ PRAHY

05



Buk morený a lakovaný,
odtieň čerešňa

07



Buk morený a lakovaný,
odtieň orech

08



Dub morený a lakovaný,
odtieň orech

09



Dub morený a lakovaný,
odtieň wenge

BUK BRÚSENÝ BEZ POVRCHOVEJ ÚPRAVY:

	120 cm			130 cm			140 cm			150 cm			160 cm		
	bez DPH €	s DPH €	s DPH SK	bez DPH €	s DPH €	s DPH SK	bez DPH €	s DPH €	s DPH SK	bez DPH €	s DPH €	s DPH SK	bez DPH €	s DPH €	s DPH SK
8 cm	8,56	10,19	307,-	9,26	11,02	332,-	13,00	15,47	466,-	13,92	16,56	499,-	14,82	17,63	531,-
10 cm	9,62	11,45	345,-	10,40	12,38	373,-	14,59	17,36	523,-	15,67	18,65	562,-	16,74	19,92	600,-
12 cm	11,55	13,74	414,-	12,52	14,90	449,-	17,57	20,91	630,-	18,80	22,37	674,-	20,03	23,83	718,-
14 cm	13,45	16,00	482,-	14,59	17,36	523,-	20,47	24,36	734,-	21,92	26,09	786,-	23,38	27,82	838,-

BUK MORENÝ A LAKOVANÝ: PRÍRODNÝ - 00, PARENÝ - 01, JELŠA - 03, ČEREŠŇA - 05, ORECH - 07

	120 cm			130 cm			140 cm			150 cm			160 cm		
	bez DPH €	s DPH €	s DPH SK	bez DPH €	s DPH €	s DPH SK	bez DPH €	s DPH €	s DPH SK	bez DPH €	s DPH €	s DPH SK	bez DPH €	s DPH €	s DPH SK
8 cm	9,62	11,45	345,-	10,40	12,38	373,-	14,59	17,36	523,-	15,67	18,65	562,-	16,74	19,92	600,-
10 cm	11,08	13,18	397,-	11,99	14,27	430,-	16,82	20,02	603,-	18,02	21,44	646,-	19,24	22,90	690,-
12 cm	13,00	15,47	466,-	14,06	16,73	504,-	19,72	23,47	707,-	21,17	25,19	759,-	22,62	26,92	811,-
14 cm	14,98	17,83	537,-	16,21	19,29	581,-	22,68	26,99	813,-	24,29	28,91	871,-	25,88	30,80	928,-

DUB BRÚSENÝ BEZ POVRCHOVEJ ÚPRAVY:

	120 cm			130 cm			140 cm			150 cm			160 cm		
	bez DPH €	s DPH €	s DPH SK	bez DPH €	s DPH €	s DPH SK	bez DPH €	s DPH €	s DPH SK	bez DPH €	s DPH €	s DPH SK	bez DPH €	s DPH €	s DPH SK
8 cm	9,62	11,45	345,-	10,40	12,38	373,-	14,59	17,36	523,-	15,67	18,65	562,-	16,74	19,92	600,-
10 cm	10,40	12,38	373,-	11,24	13,38	403,-	15,73	18,72	564,-	16,82	20,02	603,-	17,88	21,28	641,-
12 cm	12,77	15,20	458,-	13,83	16,46	496,-	19,33	23,00	693,-	20,70	24,63	742,-	22,07	26,26	791,-
14 cm	16,21	19,29	581,-	17,57	20,91	630,-	24,61	29,28	882,-	26,36	31,37	945,-	28,12	33,46	1008,-

DUB MORENÝ A LAKOVANÝ: PRÍRODNÝ - 02, ORECH - 08, WENGE - 09

	120 cm			130 cm			140 cm			150 cm			160 cm		
	bez DPH €	s DPH €	s DPH SK	bez DPH €	s DPH €	s DPH SK	bez DPH €	s DPH €	s DPH SK	bez DPH €	s DPH €	s DPH SK	bez DPH €	s DPH €	s DPH SK
8 cm	10,85	12,91	389,-	11,77	14,01	422,-	16,43	19,55	589,-	17,57	20,91	630,-	18,71	22,27	671,-
10 cm	11,77	14,01	422,-	12,77	15,20	458,-	17,80	21,18	638,-	19,11	22,74	685,-	20,39	24,26	731,-
12 cm	14,23	16,93	510,-	15,43	18,36	553,-	21,54	25,63	772,-	23,07	27,45	827,-	24,61	29,28	882,-
14 cm	16,66	19,82	597,-	18,10	21,54	649,-	25,27	30,07	906,-	27,11	32,26	972,-	28,96	34,46	1038,-

Hrúbka prahov: 20 mm

Povrchová úprava: 3 vrstvy PU laku

Drevené prahy sú čiastočne naskladnené. Väčšie zákazky na objednávku.

Na požiadanie zákazníka vyrobíme do prahu drážku a osadíme tesnenie. Cena tejto úpravy je 1,66 € bez DPH (50,-SK) za 1 bežný meter.

OKOPOVÉ PLECHY NA DVERE

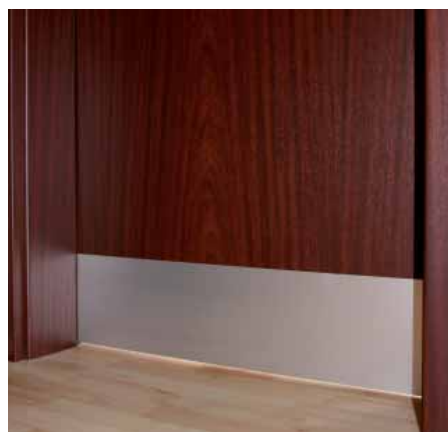

hliník elox F1

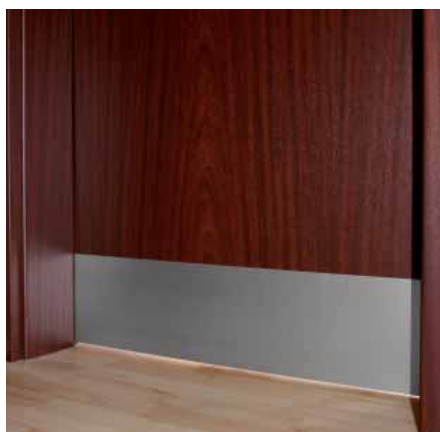

nerez brúsená

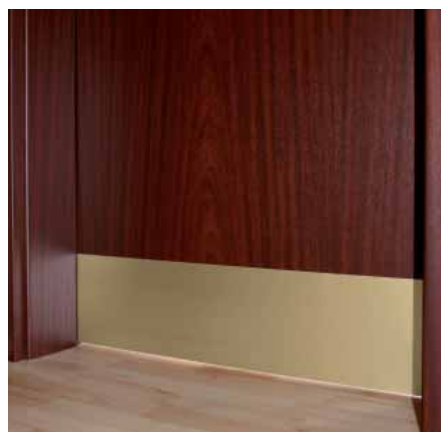

mosadz leštená

HLINÍKOVÝ ELOXOVANÝ OKOPOVÝ PLECH NA DVERE, FÓLIOVANÝ, SAMOLEPIACI, HR. 0,8mm

výška plechu	600 mm			700 mm			800 mm			900 mm			1000 mm		
	bez DPH €	s DPH €	s DPH SK	bez DPH €	s DPH €	s DPH SK	bez DPH €	s DPH €	s DPH SK	bez DPH €	s DPH €	s DPH SK	bez DPH €	s DPH €	s DPH SK
150 mm	5,39	6,41	193,-	5,86	6,97	210,-	6,45	7,67	231,-	6,97	8,30	250,-	7,78	9,26	279,-
200 mm	6,28	7,47	225,-	7,14	8,50	256,-	8,20	9,76	294,-	8,67	10,32	311,-	9,60	11,42	344,-
250 mm	7,95	9,46	285,-	8,82	10,49	316,-	9,87	11,75	354,-	10,32	12,28	370,-	11,27	13,41	404,-
300 mm	8,82	10,49	316,-	9,51	11,32	341,-	11,24	13,38	403,-	11,94	14,21	428,-	12,83	15,27	460,-
400 mm	11,94	14,21	428,-	14,20	16,90	509,-	14,61	17,39	524,-	15,43	18,36	553,-	17,91	21,31	642,-
800 mm	19,30	22,97	692,-	20,23	24,07	725,-	26,25	31,24	941,-	27,42	32,63	983,-	29,49	35,09	1057,-

NEREZOVÝ OKOPOVÝ PLECH NA DVERE, FÓLIOVANÝ, SAMOLEPIACI, HR. 0,6mm

výška plechu	600 mm			700 mm			800 mm			900 mm			1000 mm		
	bez DPH €	s DPH €	s DPH SK	bez DPH €	s DPH €	s DPH SK	bez DPH €	s DPH €	s DPH SK	bez DPH €	s DPH €	s DPH SK	bez DPH €	s DPH €	s DPH SK
150 mm	8,82	10,49	316,-	9,90	11,78	355,-	10,91	12,98	391,-	11,44	13,61	410,-	13,25	15,77	475,-
200 mm	9,90	11,78	355,-	11,66	13,88	418,-	13,25	15,77	475,-	13,61	16,20	488,-	15,26	18,16	547,-
250 mm	12,52	14,90	449,-	14,08	16,76	505,-	16,57	19,72	594,-	17,80	21,18	638,-	19,11	22,74	685,-
300 mm	14,29	17,00	512,-	15,71	18,69	563,-	19,83	23,60	711,-	20,61	24,53	739,-	21,65	25,76	776,-
400 mm	17,63	20,98	632,-	20,53	24,43	736,-	21,03	25,03	754,-	21,98	26,16	788,-	25,58	30,44	917,-
800 mm	33,17	39,47	1189,-	36,32	43,22	1302,-	38,69	46,04	1387,-	47,08	56,03	1688,-	51,46	61,24	1845,-

OKOPOVÝ PLECH NA DVERE Z LEŠTENEJ MOSADZE, FÓLIOVANÝ, SAMOLEPIACI, HR. 0,6mm

výška plechu	600 mm			700 mm			800 mm			900 mm			1000 mm		
	bez DPH €	s DPH €	s DPH SK	bez DPH €	s DPH €	s DPH SK	bez DPH €	s DPH €	s DPH SK	bez DPH €	s DPH €	s DPH SK	bez DPH €	s DPH €	s DPH SK
150 mm	14,59	17,36	523,-	16,76	19,95	601,-	18,92	22,51	678,-	19,69	23,43	706,-	23,74	28,25	851,-
200 mm	15,84	18,85	568,-	19,69	23,43	706,-	23,13	27,52	829,-	23,57	28,05	845,-	26,03	30,97	933,-
300 mm	24,91	29,64	893,-	28,12	33,46	1008,-	34,42	40,96	1234,-	36,49	43,42	1308,-	40,87	48,63	1465,-

Cena je za 1 kus (nie pár).

Dodacia lehota na okopové plechy je 10 dní.

HLINÍKOVÝ ELOXOVANÝ OKOPOVÝ PLECH NA DVERE, FÓLIOVANÝ, SAMOLEPIACI, HR. 0,8mm

CENY BALÍČKOV. VÝŠKA PLECHOV - 196mm	šírka dverí		bez DPH €	s DPH €	s DPH SK
	600 mm	615 mm / 640 mm		12,55	14,94
700 mm	715 mm / 740 mm		14,29	17,00	512,-
800 mm	815 mm / 840 mm		16,40	19,52	588,-
900 mm	915 mm / 940 mm		17,35	20,65	622,-
1000 mm	1015 mm / 1040 mm		19,19	22,84	688,-

A series of horizontal dotted lines for writing notes.

NEKONEČNÝ VÝBER KĽUČIEK

www.mp-kovania.sk

Predajca:

www.mp-kovania.sk
Bojnická 10
821 21 Bratislava
Tel.: 02/444 555 85

